

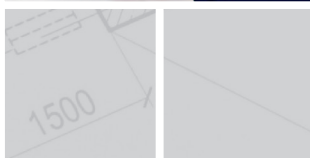

THE AUDIO COMPANY

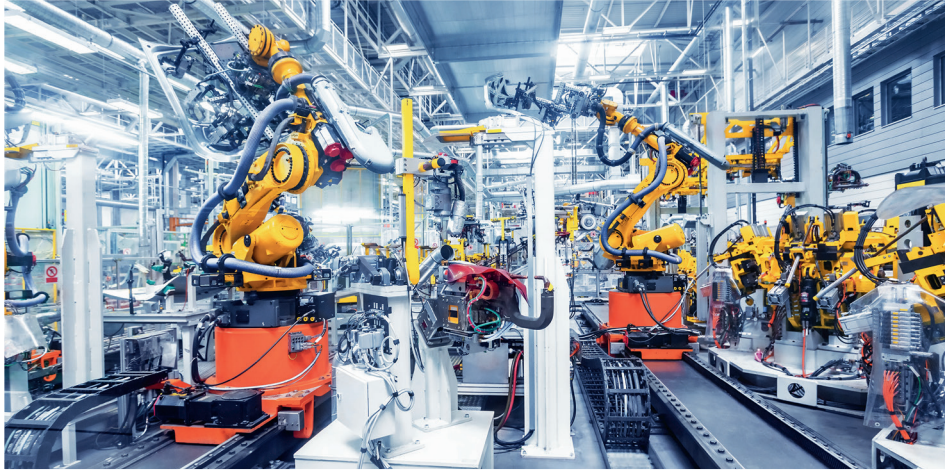

INSTALLATION

EDITION 2

Partners Worldwide

 **GERMANY**
MONACOR INTERNATIONAL
GmbH & Co. KG

Zum Falsch 36
28307 Bremen
Germany

Phone: +49 421 4865-0
Fax: +49 421 488415
info@monacor.com
www.monacor-international.de

 **ALGERIA**
IHTIRAFI MEDIA SYSTEM

 **AZERBAIDZHAN**
MONACOR POLSKA Sp. z o.o.

 **CZECH REPUBLIC**
MONACOR SLOVAKIA spol. s r.o.

 **FINLAND**
MONACOR DANMARK A/S

 **GREENLAND**
MONACOR DANMARK A/S

 **ITALY**
ZZIPP GROUP SPA

 **LITHUANIA**
MONACOR POLSKA Sp. z o.o.

 **NORWAY**
MONACOR DANMARK A/S

 **RUSSIA**
MONACOR POLSKA Sp. z o.o.

 **SPAIN**
MONACOR IBERIA, S.A.U.

 **UKRAINE**
MONACOR POLSKA Sp. z o.o.

 **ANDORRA**
MONACOR IBERIA, S.A.U.

 **BELARUS**
MONACOR POLSKA Sp. z o.o.

 **DENMARK**
MONACOR DANMARK A/S

 **FRANCE**
MONACOR FRANCE S.A.R.L.

 **HUNGARY**
MONACOR HUNGÁRIA Kft.

 **KIRGHIZIA**
MONACOR POLSKA Sp. z o.o.

 **LUXEMBOURG**
MONACOR INTERNATIONAL
GmbH & Co. KG

 **POLAND**
MONACOR POLSKA Sp. z o.o.

 **SAN MARINO**
ZZIPP GROUP SPA

 **SWEDEN**
MONACOR SVERIGE AB

 **UNITED ARAB
EMIRATES**
Levels FZ LLC

 **ARMENIA**
MONACOR POLSKA Sp. z o.o.

 **BELGIUM**
MONACOR INTERNATIONAL
GmbH & Co. KG

 **ESTONIA**
MONACOR POLSKA Sp. z o.o.

 **GEORGIA**
MONACOR POLSKA Sp. z o.o.

 **ICELAND**
MONACOR DANMARK A/S

 **LATVIA**
MONACOR POLSKA Sp. z o.o.

 **MONACO**
MONACOR FRANCE S.A.R.L.

 **PORTUGAL**
MONACOR IBERIA, S.A.U.

 **SLOVAKIA**
MONACOR SLOVAKIA spol. s r.o.

 **SWITZERLAND**
MONACOR SCHWEIZ AG

 **UNITED KINGDOM**
MONACOR UK Ltd

 **AUSTRIA**
MONACOR INTERNATIONAL
GmbH & Co. KG

 **BULGARIA**
MONACOR POLSKA Sp. z o.o.

 **FAROE ISLANDS**
MONACOR DANMARK A/S

 **GREECE**
ABAS

 **IRELAND**
MONACOR UK Ltd

 **LIECHTENSTEIN**
MONACOR SCHWEIZ AG

 **NETHERLANDS**
MONACOR INTERNATIONAL
GmbH & Co. KG

 **ROMANIA**
Kompakt Kepo Sound SRL

 **SOUTH AFRICA**
ProAudio Africa (Pty) Ltd

 **TURKEY**
KALE ELEKTRIK LTD.

 **USA**
Advanced Design and
Manufacturing, LLC

Highlights	I 1–I 7
MondeF	Spottune
Amplifiers	I 8–I 39
Multi-zone matrix amplifiers	Power amplifiers
Multi-zone mixing amplifiers	Stereo mixing amplifiers
Mixing amplifiers	Mono mixing amplifiers
Multi-channel amplifiers	Accessories
Audio Players	I 40–I 43
Players	Modules
Tuners	
Signal Processing	I 44–I 63
Matrix routers	Signal optimisation
Controllers	Volume controls
Mixers	Accessories
Voice Alarm Systems	I 64–I 75
EN 54 systems	EN 54 speakers
System components	
Speakers	I 76–I 123
Flush-mount speakers	Music horns
Wall and ceiling speakers	Horn speakers
Column speakers	Pendant speakers
Speaker systems	Projector speakers
PA systems	
Wireless Transmission	I 124–I 125
Audio-Streaming	I 126–I 131
Dante®	2N®
Conference Technology	I 132–I 150
Intercommunication	Lecterns
Wireless systems	Microphones
Accessories	
Desktop Microphones	I 151–I 155
Induction Loop Systems	I 156–I 159
Systems	

Highlights

MondeF

MondeF zone network audio server (Dante®) for professionally streaming Dante® audio data. The server is completely pre-configured with MondeF software, drivers and the Audinate Dante® software for use with Dante® audio products.

The installed software includes Internet radio (120 channels max. simultaneously), announcement feature, (programmable) alarms/announcements, scheduling, playlists etc. Furthermore, the server provides a variety of connection facilities, e.g. USB (4 x), RJ45 network connection, HDMI™ output and DisplayPort for connecting up to

2 optional monitors or touch screens, thus allowing for a convenient operation of all network components. The brand Dante® as well as the Dante® software, which may have been integrated into these products, are licenced by Audinate Pty Ltd.

MDF-12Z

Order No. 0179430



MondeF 2-zone network audio server (Dante®)

- 2 Dante® outputs
- 8 Dante® inputs
- Completely pre-configured, including installed software and drivers
- Mini server, slim design, slimline plastic housing
- Operating system: Windows 10 Professional, 64-bit version
- Processor: Intel Celeron 3865U, 1.8 GHz, Intel HD 610 graphics, supports 2160p/60 Hz
- Wireless LAN 802.11n, internal antenna

- Can be mounted as a wall device/desktop device or directly to the rear panel of a monitor/touch screen (VESA mount)
- Supplied with power supply, supporting feet and VESA mount (75/100 mm)



MDF-24Z

Order No. 0179420



MondeF 4-zone network audio server (Dante®)

- 4 Dante® outputs
- 8 Dante® inputs
- Completely pre-configured, including installed software and drivers
- Mini server, slim design, slimline plastic housing
- Operating system: Windows 10 Professional, 64-bit version
- Intel Celeron 3865U processor, 1.8 GHz, Intel HD 610 graphics, supports 2160p/60 Hz
- Wireless LAN 802.11n, internal antenna

- Can be mounted as a wall device/desktop device or directly to the rear panel of a monitor/touch screen (VESA mount)
- Supplied with power supply, supporting feet and VESA mount (75/100 mm)



MDF-48Z

Order No. 0179410



MondeF 8-zone network audio server (Dante®)

- 8 Dante® outputs
- 8 Dante® inputs
- Completely pre-configured, including installed software and drivers
- Mini server, slim design, slimline plastic housing
- Operating system: Windows 10 Professional, 64-bit version
- Intel Celeron 3865U processor, 1.8 GHz, Intel HD 610 graphics, supports 2160p/60 Hz
- Wireless LAN 802.11n, internal antenna

- Can be mounted as a wall device/desktop device or directly to the rear panel of a monitor/touch screen (VESA mount)
- Supplied with power supply, supporting feet and VESA mount (75/100 mm)



MDF-816Z

Order No. 0179400



MondeF 16-zone network audio server (Dante®)

- 16 Dante® outputs
 - 16 Dante® inputs
 - Completely pre-configured, including installed software and drivers
 - Mini server, slim design, slimline plastic housing
 - Operating system: Windows 10 Professional, 64-bit version
 - Intel Celeron 3865U processor, 1.8 GHz, Intel HD 610 graphics, supports 2160p/60 Hz
 - Wireless LAN 802.11n, internal antenna
- Can be mounted as a wall device/desktop device or directly to the rear panel of a monitor/touch screen (VESA mount)
 - Supplied with power supply, supporting feet and VESA mount (75/100 mm)



MDF-1632Z

Order No. 0179390



MondeF 32-zone network audio server (Dante®)

- 32 Dante® outputs
 - 16 Dante® inputs
 - Completely pre-configured, including installed software and drivers
 - Mini server, slim design, slimline plastic housing
 - Operating system: Windows 10 Professional, 64-bit version
 - Intel Celeron 3865U processor, 1.8 GHz, Intel HD 610 graphics, supports 2160p/60 Hz
 - Wireless LAN 802.11n, internal antenna
- Can be mounted as a wall device/desktop device or directly to the rear panel of a monitor/touch screen (VESA mount)
 - Supplied with power supply, supporting feet and VESA mount (75/100 mm)



MDF-3264Z

Order No. 0179380



MondeF 64-zone network audio server (Dante®)

- 64 Dante® outputs
 - 32 Dante® inputs
 - Completely pre-configured, including installed software and drivers
 - Mini server, slim design, slimline plastic housing
 - Operating system: Windows 10 Professional, 64-bit version
 - Intel Celeron 3865U processor, 1.8 GHz, Intel HD 610 graphics, supports 2160p/60 Hz
 - Wireless LAN 802.11n, internal antenna
- Can be mounted as a wall device/desktop device or directly to the rear panel of a monitor/touch screen (VESA mount)
 - Supplied with power supply, supporting feet and VESA mount (75/100 mm)



Model	MDF-12Z, MDF-24Z, MDF-48Z, MDF-816Z, MDF-1632Z, MDF-3264Z
Description	network audio streamer
Power supply	≙ 100-240 V/50-60 Hz/65 W max. via encl. power supply
Dimensions	142 x 142 x 42 mm
Weight	760 g
Connections	1 x USB 3.0 Type-A 1 x USB 3.0 Type-C 2 x USB 2.0 1 x SD card reader (SD, SDHC and SDXC) 1 x HDMI™ 1.4 1 x RJ45 (Gigabit LAN) 1 x display port 1.2 1 x comb. 3.5 mm audio plug (headphones and microphone) 1 x RS232 COM port (D-sub, 9 poles)

Highlights

MondeF

MDF-CON6

Order No. 1000233



MondeF control panel/system controller with 6 buttons, compatible with the AS500 series of switches from Jung. When connected to an existing network, the controller will be identified automatically via the MondeF software and will be integrated into the network. The controller features 6 programmable buttons. The key functions can be adjusted individually via the MondeF software. Supplied with logos for labelling individual buttons for the most frequently used functions. Including blank MONACOR inlay. RJ45 PoE jack for power supply and network connection.

- Supplied with inlay 'MONACOR' and various logos for labelling key functions
- Supplied w/o matching cover frame (e.g. Jung AS581) for wall mounting. Please order separately, depending on use and application



Model	MDF-CON6
Power supply	via PoE
Dimensions	55 x 55 mm (wall module/connecting plate) 80 x 80 x 25 mm (incl. cover frame)
Weight	60 g
Connections	1 x RJ45

MDF-INS-XLR

Order No. 1000217



MondeF XLR/jack plug wall module, for flush mounting.

- Compatible with the AS500 series of switches from Jung
- With screw terminal; jack plug and XLR can be connected separately
- Supplied with matching inlays labelled 'MIC' and 'LINE IN' for use with mounting frames of the AS500 series of switches from Jung
- Supplied w/o matching mounting frame (e.g. Jung AS581) for wall mounting. Please order separately, depending on use and application



Model	MDF-INS-XLR
Dimensions	55 x 55 mm (wall module/connecting plate) 80 x 80 x 45 mm (incl. cover frame)
Weight	89 g
Connections	1 x XLR plug

MDF-INS-USB

Order No. 1000216



MondeF USB Type-A/USB Type-B wall module, for flush mounting.

- Compatible with the AS500 series of switches from Jung
- Cable length: 0.2 m
- Supplied with matching inlays labelled 'USB' for use with mounting frames of the AS500 series of switches from Jung
- Can be used as USB Type-A or USB Type-B connection module
- Supplied w/o matching mounting frame (e.g. Jung AS581) for wall mounting. Please order separately, depending on use and application



Model	MDF-INS-USB
Dimensions	55 x 55 mm (wall module/connecting plate) 80 x 80 x 35 mm (incl. cover frame)
Weight	89 g
Connections	1 x USB Type-A/USB Type-B

MDF-INS-HDWP

Order No. 1000215



MondeF HDMI™ wall module, for flush mounting.

- Compatible with the AS500 series of switches from Jung
- Cable length: 0.2 m
- Supplied with inlay labelled 'HDMI™' for use with mounting frames of the AS500 series of switches from Jung
- Supplied w/o matching mounting frame (e.g. Jung AS581) for wall mounting. Please order separately, depending on use and application



Model	MDF-INS-HDWP
Dimensions	55 x 55 mm (wall module/connecting plate) 80 x 80 x 40 mm (incl. cover frame)
Weight	165 g
Connections	1 x HDMI™ jack

MDF-19TS-M

Order No. 1000214



48 cm (19") full HD touch screen, for the application with network audio servers of the MDF series.

- Full HD multi-touch panel with 10-point multi-touch technology
- Visible diagonal screen size: 49.5 cm (19.5")
- Format: 16:9 (4:3 selectable)
- Viewing angle: 178° horizontal, 178° vertical
- Contrast ratio: 3000:1, brightness: 250 cd/m²
- Built-in speaker
- Compatible with Windows, Mac, Linux and Android
- Flush mounting, wall mounting (VESA 75 mm) and desktop mounting



Model	MDF-19TS-M
Colour system	PAL/NTSC/SECAM
Screen diagonal	49.5 cm (19.5")
Aspect ratio	16:9 (4:3 selectable)
Resolution	1920 x 1080 pixels
Power supply	= 9-33 V via encl. power supply ~ 110-240 V/50-60 Hz/24 W
Admiss. ambient temp.	-20+60 °C
Dimensions	479 x 294 x 44 mm
Weight	5.01 kg (5.86 kg with base)
Connections	1 x HDMI™ 1 x VGA 1 x BNC (CVBS) 1 x RCA phono video 1 x 3.5 mm plug input 1 x 3.5 mm plug output 1 x USB (for touch screen functionality only)

MDF-15TS-M

Order No. 1000213



38 cm (15") full HD touch screen, for the application with network audio servers of the MDF series.

- Full HD multi-touch panel with 10-point multi-touch technology
- Visible diagonal screen size: 39.7 cm (15.6")
- Format: 16:9 (4:3 selectable)
- Viewing angle: 178° horizontal, 178° vertical
- Contrast ratio: 700:1, brightness: 400 cd/m²
- Built-in speaker
- Compatible with Windows, Mac, Linux and Android
- Flush mounting, wall mounting (VESA 75 mm) and desktop mounting



Model	MDF-15TS-M
Colour system	PAL/NTSC/SECAM
Screen diagonal	39.7 cm (15.6")
Aspect ratio	16:9 (4:3 selectable)
Resolution	1920 x 1080 pixels
Power supply	= 9-33 V via encl. power supply ~ 110-240 V/50-60 Hz/24 W
Admiss. ambient temp.	-20+60 °C
Dimensions	386 x 238 x 41 mm
Weight	2.92 kg (3.34 kg with base)
Connections	1 x HDMI™ 1 x VGA 1 x BNC (CVBS) 1 x RCA phono video 1 x 3.5 mm plug input 1 x 3.5 mm plug output 1 x USB (for touch screen functionality only)

MDF-12TS-M

Order No. 1000220



30 cm (12") full HD touch screen, for the application with network audio servers of the MDF series.

- Full HD multi-touch panel with 10-point multi-touch technology
- Visible diagonal screen size: 29.5 cm (11.6")
- Format: 16:9 (4:3 selectable)
- Viewing angle: 178° horizontal, 178° vertical
- Contrast ratio: 700:1, brightness: 400 cd/m²
- Built-in speaker
- Compatible with Windows, Mac, Linux and Android
- Flush mounting, wall mounting (VESA 75 mm) and desktop mounting



Model	MDF-12TS-M
Colour system	PAL/NTSC/SECAM
Screen diagonal	29.5 cm (11.6")
Aspect ratio	16:9 (4:3 selectable)
Resolution	1920 x 1080 pixels
Power supply	= 9-33 V via encl. power supply ~ 110-240 V/50-60 Hz/24 W
Admiss. ambient temp.	-20+60 °C
Dimensions	297 x 184 x 38 mm
Weight	1.29 kg (1.71 kg with base)
Connections	1 x HDMI 1 x VGA 1 x BNC (CVBS) 1 x RCA phono video 1 x 3.5 mm plug input 1 x 3.5 mm plug output 1 x USB (for touch screen functionality only)

MDF-10TS-M

Order No. 1000212



25 cm (10") full HD touch screen, for the application with network audio servers of the MDF series.

- Full HD multi-touch panel with 10-point multi-touch technology
- Visible diagonal screen size: 25.7 cm (10.1")
- Format: 16:10 (4:3 and 16:9 selectable)
- Viewing angle: 178° horizontal, 178° vertical
- Contrast ratio: 600:1
- Brightness: 400 cd/m²
- Built-in speaker
- Compatible with Windows, Mac, Linux and Android
- Flush mounting, wall mounting (VESA 75 mm) and desktop mounting

- Black metal housing
- Supplied with mounting strips for flush mounting, remote control, power supply, base and USB cable



Model	MDF-10TS-M
Colour system	PAL/NTSC/SECAM
Screen diagonal	25.7 cm (10.1")
Aspect ratio	16:10 (4:3 and 16:9 selectable)
Resolution	1920 x 1200 pixels
Power supply	= 9-33 V via encl. power supply ~ 110-240 V/50-60 Hz/24 W
Admiss. ambient temp.	-20+60 °C
Dimensions	249 x 170 x 37 mm
Weight	1.29 kg (1.71 kg with base)
Connections	1 x HDMI™ 1 x VGA 1 x BNC (CVBS) 1 x RCA phono video 1 x 3.5 mm plug input 1 x 3.5 mm plug output 1 x USB (for touch screen functionality only)

Spottune OMNI TRACK speaker: wireless 360° speaker for application and mounting to 3-phase high-voltage rail lighting systems, installation via a global track adapter.

Instead of being optimised for a frontal listening position as it is the case with standard speakers, the Spottune OMNI TRACK speaker is acoustically designed to provide a homogeneous radiation. The 360° sound radiation is recommended for environments which require a homogeneous sound radiation to create a consistent listening experience throughout the room. This results in an enhanced listening comfort and a consistent, room-filling sound experience.

Compared with standard speaker systems, you also require less speakers for the installation of a speaker system in a PA application, thanks to 360° sound radiation. The Spottune OMNI TRACK speakers are controlled and managed via radio link, using the Spottune network audio streamer STREAM. One Spottune network audio streamer

STREAM is required for each Spottune speaker system which consists of up to 30+ Spottune speakers. Please order this separately.

The easy installation and configuration as well as the possibility to easily adapt the Spottune speaker system to changing requirements and spatial conditions, make the system the ideal partner for use in commercial areas such as retail trade, restaurants and bars, hotels, offices, etc.

Supplied with the GA 69 global track adapter for mounting on a 3-phase high-voltage rail.

OMNI-TRACK/SW

Order No. 1000604



OMNI-TRACK/WS

Order No. 1000605

Spottune OMNI TRACK speakers

- All-in-one smart speaker (built-in amplifier, audio filter and receiver)
- Easy plug-and-play installation to existing 3-phase rail lighting systems
- Automatic linking and settings in pairing mode with LED status indication at initial operation via Spottune network audio streamer STREAM
- Consistent 360° sound radiation for a constantly pleasant sound experience, independent of the position in the room
- Well-balanced and clear sound at low volume
- Reliable and stable audio transmission in the frequency range of 1.9 GHz
- Closed full range speaker system

Supplied w/o lighting rails.



Model	OMNI-TRACK/SW, OMNI-TRACK/WS
Power rating (RMS)	50 W, class D amplifier
Frequency range	50-15,000 Hz
Beam angle	360° radiation
Mounting device	global track adapter GA 69
Power supply	~ 100-240 V/50-60 Hz/2 VA max. via 3-phase high-voltage rail
Dimensions	Ø 115 x 200 mm
Weight	1.5 kg

Spottune OMNI CORD speaker: wireless 360° pendant speaker for suspended installation into standard ceiling outlets via pre-installed two-wire cable.

The pendant length of 5 m can individually be adjusted, depending on the respective ceiling height.

OMNI-CORD/SW

Order No. 1000658



OMNI-CORD/WS

Order No. 1000659

Spottune OMNI CORD speakers

- All-in-one smart speaker (built-in amplifier, audio filter and receiver)
- Easy plug-and-play installation via standard ceiling outlet
- Automatic linking and settings in pairing mode with LED status indication at initial operation via Spottune network audio streamer STREAM
- Consistent 360° sound radiation for a constantly pleasant sound experience, independent of the position in the room
- Well-balanced and clear sound at low volume
- Reliable and stable audio transmission in the frequency range of 1.9 GHz
- Closed full range speaker system



Model	OMNI-CORD/SW, OMNI-CORD/WS
Power rating (RMS)	50 W, class D amplifier
Frequency range	50-15,000 Hz
Beam angle	360° radiation
Power supply	~ 100-240 V/50-60 Hz/2 VA max. via standard ceiling outlet
Dimensions	Ø 115 x 200 mm

Spottune OMNI REC recessed speaker: wireless 360° ceiling mount speaker for installation into suspended ceilings. The minimum mounting depth is 45 mm, power is supplied via standard ceiling outlet using the supplied junction box.

OMNI-REC/SW

Order No. 1000660



OMNI-REC/WS

Order No. 1000661



Spottune OMNI REC recessed speakers

- All-in-one smart speaker (built-in amplifier, audio filter and receiver)
- Easy plug-and-play installation via standard ceiling outlet
- Automatic linking and settings in pairing mode with LED status indication at initial operation via Spottune network audio streamer STREAM
- Consistent 360° sound radiation for a constantly pleasant sound experience, independent of the position in the room
- Well-balanced and clear sound at low volume
- Reliable and stable audio transmission in the frequency range of 1.9 GHz
- Closed full range speaker system

Model	OMNI-REC/SW, OMNI-REC/WS
Power rating (RMS)	50 W, class D amplifier
Frequency range	50-15,000 Hz
Beam angle	360° radiation
Power supply	~ 100-240 V/50-60 Hz/2 VA max. via standard ceiling outlet
Dimensions	Ø 115 x 200 mm ceiling cutout: 155-160 mm mounting depth: 45-100 mm
Weight	1.5 kg

Central audio/music streamer for Spottune speaker systems



STREAM

Order No. 1000606



Spottune STREAM audio streamer

- Central transmitter and receiver unit (high operating reliability due to DECT technology)
- 2 music zones can be controlled individually
- Microphone input for announcements
- Web-based DSP and control surface
- Spotify Connect
- USB port for music reproduction
- Different music contents can be played in separate zones
- Status monitoring of integrated speakers
- Announcements via all speakers using microphone

Model	STREAM
Description	wireless audio streamer
Nominal value	audio transmission: UHF band 1.8-1.9 GHz, operating range: approx. 50-100 m, depending on surrounding and place of application
Suitable for	Spottune speaker systems
Power supply	~ 100-240 V/50-60 Hz via encl. power supply
Dimensions	230 x 45 x 200 mm
Weight	600 g
Connections	output for 1 or 2 music zones inputs: RJ45 (LAN), 3.5 mm jack (AUX IN), 3.5 mm jack (MIC IN)

Subwoofer extension for Spottune speaker systems



SUB/SW

Order No. 1000662



SUB/WS

Order No. 1000663



Spottune wireless smart subwoofers, as an addition to existing Spottune speaker systems for extending the bass reproduction.

- All-in-one smart subwoofer (built-in 200 W amplifier and receiver)
- 25 cm (10") bass speaker/driver of long excursion
- Closed cabinet design for optimum output power and extended bass reproduction
- Easy plug-and-play installation/connection to Spottune audio streamer STREAM
- Reliable and stable audio transmission in the frequency range of 1.9 GHz

Model	SUB/SW, SUB/WS
Power rating (RMS)	200 W, class D amplifier
Frequency range	20-200 Hz
Power supply	~ 100-240 V/50-60 Hz
Dimensions	540 x 200 x 360 mm
Weight	12.65 kg



PA-40120

Order No. 0173220



4-zone mono mixing amplifier, with 4 active 120 W outputs,

for setting up a multi-zone PA system. A switch allows each of the 5 inputs to be assigned to one of the 4 outputs. Thus, it is possible to reproduce varying programmes in different areas. Another advantage is that an announcement in one area will not interrupt the programme in another area.

With optional zone-paging microphone PA-4000RC, the amplifier can be extended to a 4-channel PA system. In combination with an integrated voice memory, an alarm system can be set up in schools, for example.

- 4 x 120 W
- 4 zones, can be controlled individually
- 3 mic/line inputs and 2 line inputs
- Built-in adjustable monitor speaker
- Chime and siren can also be activated via external momentary push-button
- Bass, treble and master controls, level display via LEDs, regulated fan
- 15 V phantom power for electret microphones
- Connection for microphone PA-4000PTT
- Optional connection for up to 32 zone paging microphones PA-4000RC
- Mains operation and 24 V emergency power operation

Model	PA-40120
Peak output power	4 x 120 W
Power rating	4 x 120 W
Inputs	2.5 mV/5 kΩ, 0.3 V/15 kΩ (mic/line 1-3), 0.3 V/15 kΩ (line 4-5)
Frequency range	45-20,000 Hz
Equalizer bass	± 10 dB/100 Hz
Equalizer treble	± 10 dB/10 kHz
S/N ratio	> 70 dBA (mic), > 90 dBA (line)
THD	< 1%
Power supply	~ 230 V/50 Hz/1,500 VA, ~ 24 V/40 A
Dimensions	482 x 90 x 377 mm, 2 RU
Weight	22.1 kg

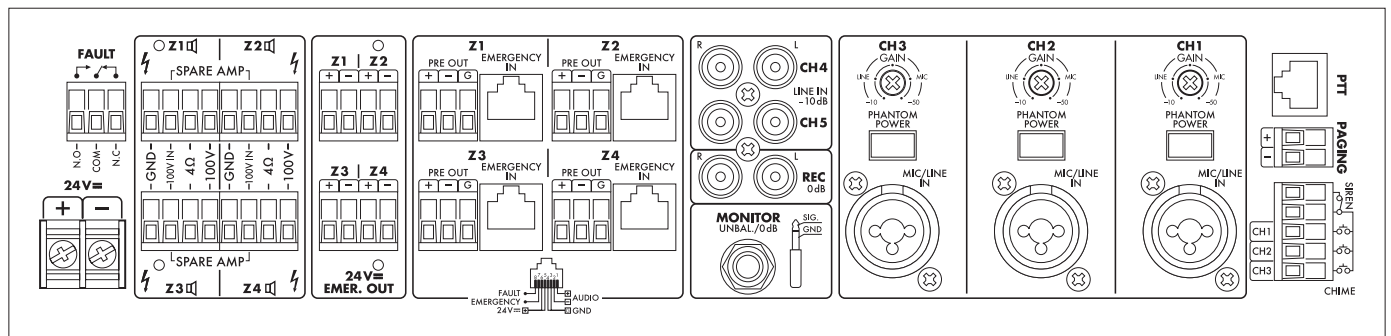

PA-4000RC

Order No. 0236010

PA 4-zone paging desktop microphone, for PA-40120 and PA-6040MPX.

- Selection buttons for 4 zones, for activating one or several zones
- ALL-CALL button for activating all of the 4 zones
- Autom. chime via microphone announcement button (talk)
- Chime can be activated or deactivated as required
- 24 V power supply via PA-40120 or PA-6040MPX
- Two RJ45 jacks for connection to PA-40120, PA-6040MPX or optional power supply and additional microphones PA-4000RC

- Supplied with connection module for PA-40120 and PA-6040MPX
- Up to 32 x PA-4000RC can be connected to PA-40120 or PA-6040MPX via bus
- Supplied with 3 m connection cable (Cat. 5e)



CLASSIC LINE

PA-M224

Order No. 0179280



2-zone PA matrix mixing amplifier

- 240 W per zone
- 2 zones, can be controlled individually, with 2-way tone control
- Class D concept with a high efficiency to cut energy costs
- 4 adjustable mic/line inputs with 3-way equalizer and 24 V phantom power, to be activated as required
- 4 adjustable line inputs
- Mute function for muting individual zones
- Connection for external mute switch (all zones simultaneously)



- Talkover (channel 1)
- Adjustable monitor function
- 1 connection for zone paging microphone PA-M4RC
- 2 connections for wall module PA-M1WP
- 482 mm (19") rack installation

Model	PA-M224
Peak output power	2 x 290 W
Power rating	2 x 240 W
Inputs	2.5 mV/20 kΩ (mic), 2 V/20 kΩ (line)
Frequency range	20-20,000 Hz
Equalizer bass	±12 dB/80 Hz (channels 1-4) ±15 dB/80 Hz (zones 1-4)
Equalizer midrange	±12 dB/2.5 kHz (channels 1-4)
Equalizer treble	±12 dB/12.5 kHz (channels 1-4) ±15 dB/12 kHz (zones 1-4)
S/N ratio	> 70 dB
THD	< 0.1%
Power supply	~ 230 V/50 Hz/800 VA
Dimensions	482 x 88 x 320 mm, 2 RU
Weight	5.7 kg

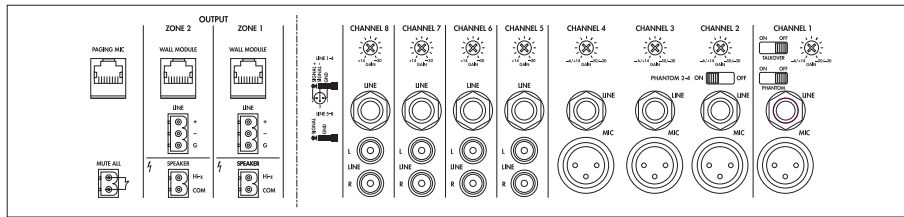

PA-M412

Order No. 0179290



4-zone PA matrix mixing amplifier

- 120 W per zone
- 4 zones, can be controlled individually with 2-way tone control
- Class D concept with a high efficiency to cut energy costs
- 4 adjustable mic/line inputs with 3-way equalizer and 24 V phantom power, to be activated as required
- 4 adjustable line inputs
- Mute function for muting individual zones
- Connection for external mute switch (all zones simultaneously)



- Talkover (channel 1)
- Adjustable monitor function
- 1 connection for zone paging microphone PA-M4RC
- 4 connections for wall module PA-M1WP
- 482 mm (19") rack installation

Model	PA-M412
Peak output power	4 x 170 W
Power rating	4 x 120 W
Inputs	2.5 mV/20 kΩ (mic), 2 V/20 kΩ (line)
Frequency range	20-20,000 Hz
Equalizer bass	±12 dB/80 Hz (channels 1-4) ±15 dB/80 Hz (zones 1-4)
Equalizer midrange	±12 dB/2.5 kHz (channels 1-4)
Equalizer treble	±12 dB/12.5 kHz (channels 1-4) ±15 dB/12 kHz (zones 1-4)
S/N ratio	> 70 dB
THD	< 0.1%
Power supply	~ 230 V/50 Hz/860 VA
Dimensions	482 x 88 x 320 mm, 2 RU
Weight	6.2 kg

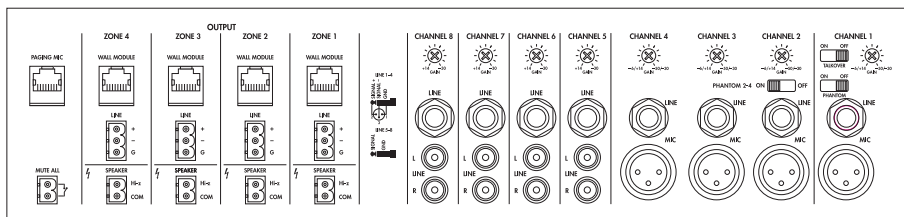

PA-M1WP

Order No. 0179300

Wall module, for local insertion of audio signals to PA matrix mixing amplifier PA-M224 or PA-M412.

- Intended application: volume control of respective zone, local insertion of audio signals
- 2 x RCA jack for line signals
- Mic. connection via 3-pole XLR jack
- 14 V phantom power, to be activated as required
- Volume control
- Signal selector button with LED indication which allows a priority circuit of locally inserted audio signals (MIC or



- Connection to PA-M224 or PA-M412 and power supply via RJ45 jack and Cat. 5 network cable (copper, suppl. w/o cable), cable length up to 200 m
- Matching flush-mounted housing ATT-300C is available at option

PA-M4RC

Order No. 0179310

PA zone paging microphone, for PA matrix mixing amplifier PA-M224 or PA-M412.

- 4 zone selector switch
- ALL-CALL button
- Plug-in electret gooseneck microphone (3-pole XLR jack)
- Phantom power for gooseneck microphone
- LED indication for signal status
- Power supply via PA-M224 or PA-M412
- Connection to PA-M224 or PA-M412 via RJ45 jack and Cat. 5e network



cable (copper, supplied w/o cable), cable length up to 200 m



PA-12040

Order No. 0173390



PA-4040

Order No. 0172520



4-zone matrix mixing amplifiers, with professional features for general multi-room PA applications.

- 120 W per zone (PA-12040)
- 40 W per zone (PA-4040)
- 100 V and 4/8 Ω operation
- Perfect utilisation of the capacity and reliable protection of connected speakers due to an integrated limiter
- 3 inputs microphone/line via comb. jacks
- 2 inputs line stereo via RCA jacks
- Each input channel with gain control, 2-way tone control, channel mute switch and zone routing switch
- Microphone inputs with phantom power, to be activated as required (PA-12040: 46 V, PA-4040: 15 V)
- Priority function for channel 1, switchable
- Independent paging input, can be routed to all zones
- 4 zone outputs, can be controlled individually

- Zone and monitor line outputs for additional amplifiers or recorders
- Connection for monitor speakers
- Level control via VU meters for zone and monitor
- Adjustable headphone output
- Fan cooling
- 230 V mains operation

Model	PA-12040	PA-4040
Peak output power	4 x 170 W	4 x 65 W
Power rating	4 x 120 W	4 x 40 W
Inputs	5 mV/4 kΩ, 100 mV/10 kΩ (mic/line) 100 mV/30 kΩ (line) 40 mV/5 kΩ (tel. paging)	5 mV/4 kΩ, 100 mV/10 kΩ (mic/line), 100 mV/30 kΩ (line)
Frequency range	50-17,000 Hz	50-17,000 Hz
Equalizer bass	± 10 dB/100 Hz	± 10 dB/100 Hz
Equalizer treble	± 10 dB/10 kHz	± 10 dB/10 kHz
S/N ratio	> 65 dB, mic > 75 dB, line	> 65 dB (mic), > 75 dB (line)
THD	< 1%	< 1%
Power supply	~ 230 V/50 Hz/1,200 VA	~ 230 V/50 Hz/450 VA
Dimensions	482 x 133 x 410 mm, 3 RS	482 x 133 x 310 mm, 3 RU
Weight	20.5 kg	15 kg

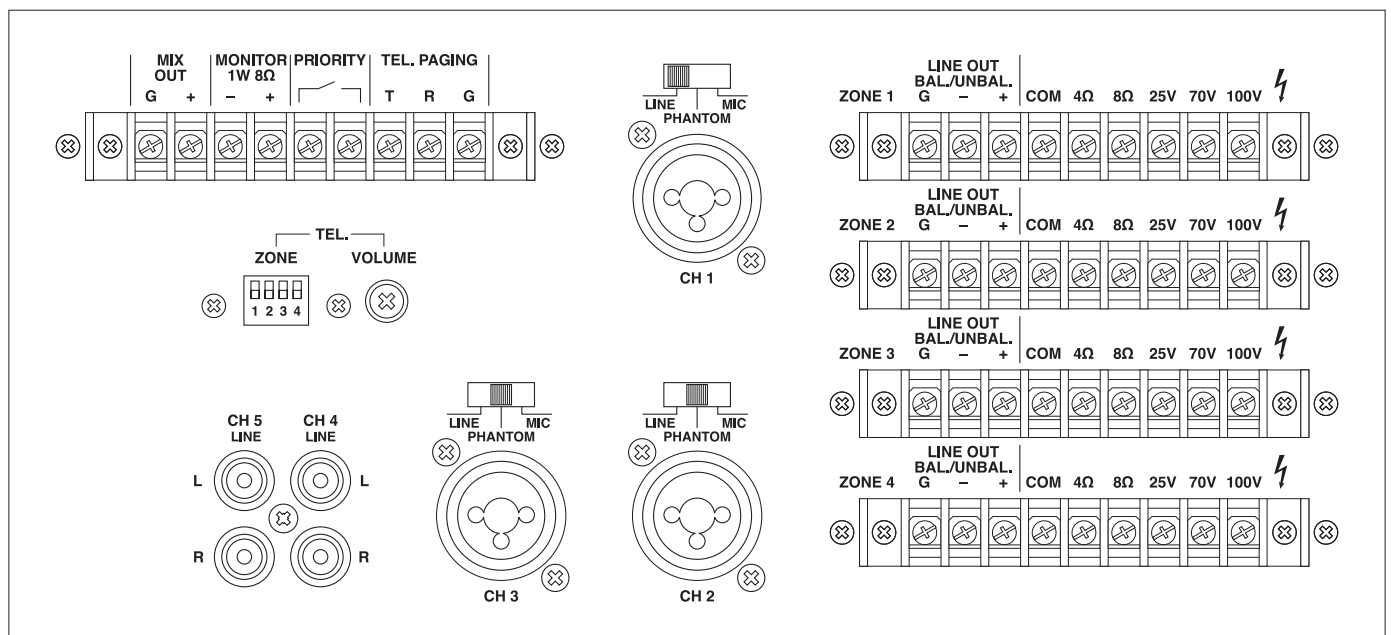

PERFORMANCE LINE

PA-6020Z

Order No. 1000126



20-zone mono PA mixing amplifier

- 1 x 600 W
- 20 zones, can be controlled individually
- 3 inputs microphone/line via comb. jacks
- 2 inputs stereo line via RCA jacks
- Chime, contin. sound and wailing sound, automatic mute, 2-tone chime or 4-tone chime (selectable)
- Bass, treble and master controls, LEDs for indicating signal/clip, regulated fan
- Insertions for various functions are available at option
- 15 V phantom power for electret microphones
- Connection for up to 32 zone paging microphones PA-2400RC
- Connection for up to 3 push-to-talk mics PA-4300PTT



- Alarm announcement with insertion PA-1120DMT (available at option)
- Mains operation and 24 V emergency power operation
- Removable mounting brackets

Model	PA-6020Z
Power rating	600 W
Power rating at 100 V	600 W
Inputs	2.5 mV/5 kΩ, 0.3 V/5 kΩ (mic/line 1-3), 0.3 V/15 kΩ (line 4-5), 0.775 V/100 kΩ (preamplifier)
Frequency range	55-16,000 Hz
Equalizer bass	±10 dB/100 Hz
Equalizer treble	±10 dB/10 kHz
S/N ratio	> 70 dB (mic), > 80 dB (line)
THD	< 1%
Power supply	~ 230 V/50 Hz/1,700 VA, ~ 24 V/50 A
Dimensions	482 x 133 x 352 mm, 3 RU
Weight	21 kg

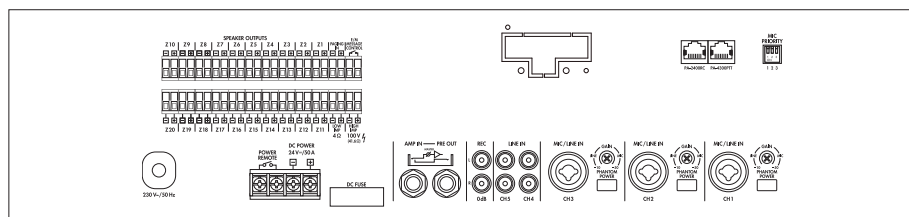

PA-6010Z

Order No. 1000125



10-zone mono PA mixing amplifier

- 1 x 600 W
- 10 zones, can be controlled individually
- 3 inputs microphone/line via comb. jacks
- 2 inputs stereo line via RCA jacks
- Additional 60 W amplifier for separate announcements via zone paging microphone PA-2400RC, if not more than 2 zones are selected
- Bass, treble and master controls, LEDs for indicating signal/clip, regulated fan
- Insertions for various functions are available at option
- 15 V phantom power for electret microphones
- Connection for up to 32 zone paging microphones PA-2400RC
- Connection for up to 3 push-to-talk mics. PA-4300PTT



- Alarm announcement with insertion PA-1120DMT (available at option)
- Mains operation and 24 V emergency power operation
- Removable mounting brackets

Model	PA-6010Z
Power rating	600 W
Power rating at 100 V	600 W
Inputs	2.5 mV/5 kΩ, 0.3 V/5 kΩ (mic/line 1-3), 0.3 V/15 kΩ (line 4-5), 0.775 V/100 kΩ (preamplifier)
Frequency range	55-16,000 Hz
Equalizer bass	±10 dB/100 Hz
Equalizer treble	±10 dB/10 kHz
S/N ratio	> 70 dB (mic), > 80 dB (line)
THD	< 1%
Power supply	~ 230 V/50 Hz/1,700 VA, ~ 24 V/50 A
Dimensions	482 x 133 x 352 mm, 3 RU
Weight	22 kg

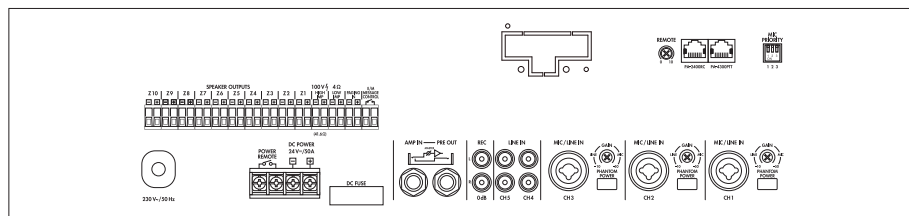

PA-2400RC

Order No. 0236840

PA zone paging desktop microphone, for connection to PA-1120, PA-1240, PA-2420Z, PA-6010Z or PA-6020Z.

- Selection buttons for speaker zones 1-20
- Start/stop function for 6 selectable announcements which are stored in the digital module PA-1120DMT, available at option
- LED indication for various functions
- Automatic chime via mic. announcement button

- Adjustable microphone sensitivity
- 24 V power supply via PA-2410Z, PA-2420Z
- RJ45 jacks for connection to additional PA-2400RC with slave/priority switch
- Up to 3 x PA-2400RC can be connected to PA-2410Z or PA-2420Z
- Supplied with 3 m connection cable (Cat. 5e)



PA-6240

Order No. 0172180



PA-6480

Order No. 0172190



PA-6600

Order No. 0172390



6-zone mono PA mixing amplifiers

- 1 x 240 W (PA-6240)
- 1 x 480 W (PA-6480)
- 1 x 600 W (PA-6600)
- 6 zones, can be controlled individually
- Chime, continuous sound and wailing sound, automatic mute, 2-tone chime or 4-tone chime (selectable)
- Bass, treble and master controls, level display via LEDs, regulated fan
- Insertions for various functions are available at option
- 17 V phantom power for electret microphones
- Connection for zone paging microphone PA-6000RC
- 1 insertion compartment at the front for automatic alarm message insertion PA-1120DMT, a tuner insertion or a CD player insertion, all available at option
- 3 insertion facilities on the rear panel for optional modules with the following features:
 - PA-6FD: fault detection
 - PA-6FM: fault monitoring
 - PA-6FR: anti-feedback
- Mains operation and 24 V emergency power operation
- Removable mounting brackets



Model	PA-6240	PA-6480	PA-6600
Peak output power	340 W	680 W	850 W
Power rating	240 W	480 W	600 W
Inputs	2.5 mV/5 kΩ, 0.3 V/5 kΩ (mic/line), 0.3 V/15 kΩ (line), 0.775 V/10 kΩ (preamplifier)	2.5 mV/5 kΩ, 0.3 V/5 kΩ (mic/line), 0.3 V/15 kΩ (line), 0.775 V/10 kΩ (preamplifier)	2.5 mV/5 kΩ, 0.3 V/5 kΩ (mic/line), 0.3 V/15 kΩ (line), 0.775 V/10 kΩ (preamplifier)
Frequency range	55-16,000 Hz	55-16,000 Hz	55-16,000 Hz
Equalizer bass	± 10 dB/100 Hz	± 10 dB/100 Hz	± 10 dB/100 Hz
Equalizer treble	± 10 dB/10 kHz	± 10 dB/10 kHz	± 10 dB/10 kHz
S/N ratio	> 70 dBA (mic), > 80 dBA (line)	> 70 dBA (mic), > 80 dBA (line)	> 70 dBA (mic), > 80 dBA (line)
THD	< 1%	< 1%	< 1%
Power supply	~230 V/50 Hz/750 VA, = 24 V/20 A	~230 V/50 Hz/1,500 VA, = 24 V/40 A	~230 V/50 Hz/1,700 VA, = 24 V/50 A
Dimensions	430 x 133 x 352 mm, 3 RU	430 x 133 x 352 mm, 3 RU	430 x 133 x 352 mm, 3 RU
Weight	15 kg	19 kg	20 kg

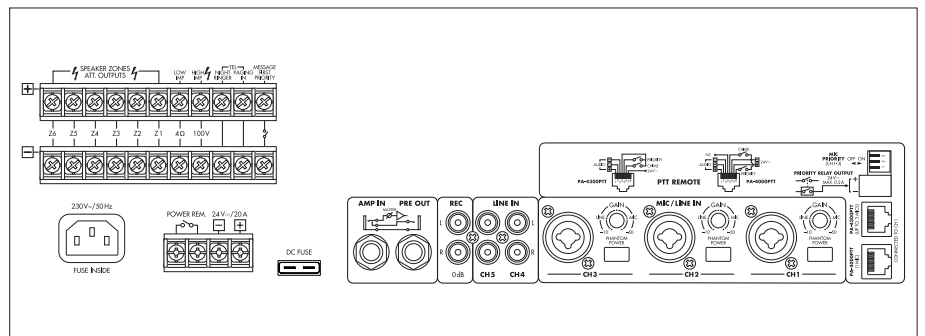

PA-6FD

Order No. 0172300

Fault detection module

- For PA amplifiers PA-6240, PA-6480, PA-6600 and PA-1960
- Module transmits a 20 kHz pilot tone in order to monitor functions of the PA amplifier
- In case of a fault, a floating relay contact will be opened
- Adjustable sensitivity



PA-6FM

Order No. 0172310

Fault monitoring module, for PA amplifiers PA-6240, PA-6480, PA-6600 and PA-1960.

- Indication of mains voltage failure and operating voltage failure
- Indication in case of fan failure
- 3 independent, floating relay outputs (NO/NC)

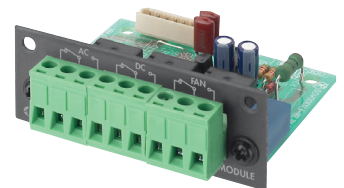

PA-6FR

Order No. 0172320

Anti-feedback module, for PA amplifiers PA-6240, PA-6480 and PA-6600.

Module uses the frequency shift method. Only affects mic 1.



PATL-105

Order No. 1000266



5-way 100 V transformer, for connecting a 100 V audio signal source to devices with line inputs.

- Suitable for PA mixing amplifiers PA-1120, PA-1240, PA-6240, PA-6480, PA-6600
- Transforms 100 V output signals into line signals to 5 lines (galvanically isolated)



- To be mounted directly to the rear panel of a respective amplifier
- Frequency range: 15-30,000 Hz
- Dimensions: 120 x 75 x 60 mm
- Weight: 405 g

PERFORMANCE LINE

PA-1120

Order No. 0170780



PA-1240

Order No. 0170790



5-zone mono PA mixing amplifiers

- 1 x 120 W (PA-1120)
- 1 x 240 W (PA-1240)
- 5 zones, can be controlled individually
- Chime, contin. sound and wailing sound, automatic mute, 2-tone chime or 4-tone chime (selectable)
- Bass, treble and master controls, level display via LEDs, regulated fan
- Insertions for various functions are available at option
- 17 V phantom power for electret microphones
- Connection for zone paging microphone PA-1120RC (available at option)
- Connection for push-to-talk microphone PA-4000PTT or PA-4300PTT
- Automatic alarm announcement with insertion



PA-1120DMT (available at option)

- Mains operation and 24 V emergency power operation
- Removable mounting brackets

Model	PA-1120	PA-1240
Peak output power	170 W	340 W
Power rating	120 W	240 W
Inputs	2.5 mV/5 kΩ, 0.3 V/5 kΩ (mic/line), 0.3 V/15 kΩ (line), 0.775 V/10 kΩ (preamplifier)	2.5 mV/5 kΩ, 0.3 V/5 kΩ (mic/line), 0.3 V/15 kΩ (line), 0.775 V/10 kΩ (preamplifier)
Frequency range	55-16,000 Hz	55-16,000 Hz
Equalizer bass	± 10 dB/100 Hz	± 10 dB/100 Hz
Equalizer treble	± 10 dB/10 kHz	± 10 dB/10 kHz
S/N ratio	> 70 dB (mic), > 80 dB (line)	> 70 dB (mic), > 80 dB (line)
THD	< 1%	< 1%
Power supply	~ 230 V/50 Hz/340 VA, ~ 24 V/15 A	~ 230 V/50 Hz/630 VA, ~ 24 V/27 A
Dimensions	482 x 133 x 352 mm, 3 RU	482 x 133 x 352 mm, 3 RU
Weight	13 kg	14 kg

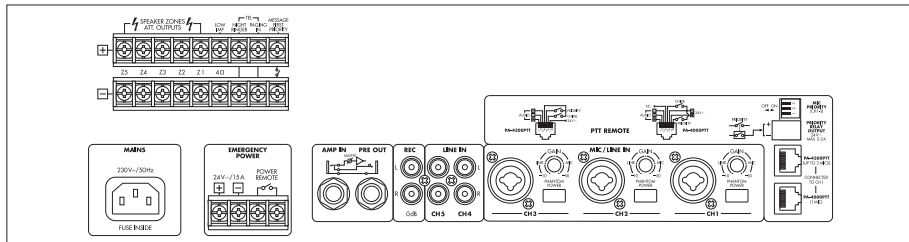

PA-5240

Order No. 0243140



PA-5480

Order No. 0243150



5-zone mono PA mixing amplifiers

- 1 x 240 W (PA-5240)
- 1 x 480 W (PA-5480)
- 5 zones, can be controlled individually
- Chime, wailing sound, automatic mute, chime and siren can also be activated via external mom. push-button, 2-tone chime or 4-tone chime (selectable)
- Bass, treble and master controls, level display via LEDs, regulated fan
- Insertions for various functions are available at option
- 18 V phantom power for electret microphones
- Connection for desktop microphone PA-5000PTT



- Alarm announcement with insertion PA-1120DMT (available at option)
- Mains operation and 24 V emergency power operation
- Removable mounting brackets

Model	PA-5240	PA-5480
Peak output power	340 W	680 W
Power rating	240 W	480 W
Power rating at 8 Ω	1 x 240	1 x 480 W
Power rating at 100 V	240 W	480 W
Inputs	2.5 mV/2 kΩ (mic 1), 2.5 mV/2 kΩ, 0.3 V/200 kΩ (mic/line 2-4), 0.3 V/5 kΩ (line 5-7), 0.775 V/10 kΩ (preamplifier)	2.5 mV/2 kΩ (mic 1), 2.5 mV/2 kΩ, 0.3 V/200 kΩ (mic/line 2-4), 0.3 V/5 kΩ (line 5-7), 0.775 V/10 kΩ (preamplifier)
Frequency range	55-16,000 Hz	55-16,000 Hz
Equalizer bass	± 10 dB/100 Hz	± 10 dB/100 Hz
Equalizer treble	± 10 dB/10 kHz	± 10 dB/10 kHz
S/N ratio	> 70 dB (mic), > 80 dB (line)	> 70 dB (mic), > 80 dB (line)
THD	< 1%	< 1%
Power supply	~ 230 V/50 Hz/750 VA, ~ 24 V/20 A	~ 30 V/50 Hz/1,500 VA, ~ 24 V/40 A
Dimensions	482 x 133 x 352 mm, 3 RU	482 x 133 x 352 mm, 3 RU
Weight	16 kg	17 kg

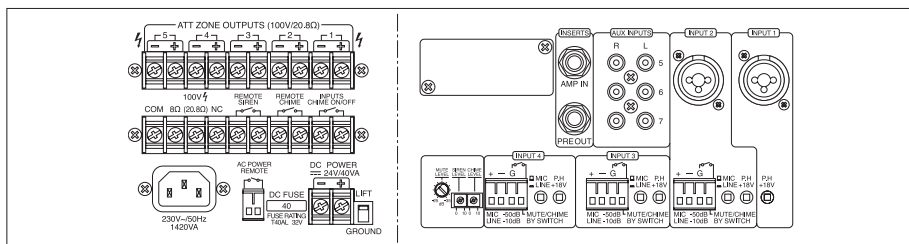

PA-6000RC

Order No. 0235370

PA zone paging desktop microphone, for connection to PA-6240, PA-6480 and PA-6600.

- Push-buttons for selecting speaker zones 1-6 and ALL-CALL function
- Start/pause function for 6 selectable announcements which are stored in the digital module PA-1120DMT
- Autom. chime via microphone announcement button
- Adjustable line input (RCA L/R) for connection of a signal source, e.g. CD player or tape deck

- LED indication for transmission mode
- Power supply via PA-6240, PA-6480, PA-6600
- RJ45 jack for connection to additional PA-6000RC microphones with slave/priority switch
- Supplied with connection module for PA-6240, PA-6480 and PA-6600



PA-1120RC

Order No. 0232440

PA zone paging desktop microphone, for connection to PA-1120 and PA-1240.

- Push-buttons for selecting speaker zones 1-5 and ALL-CALL function
- Start/pause function for 6 selectable announcements which are stored in the digital module PA-1120DMT
- Adjustable line input (RCA L/R) for connection of a signal source, e.g. CD player or tape deck
- LED indication for transmission mode

- Autom. chime via microphone announcement button
- Power supply via PA-1120, PA-1240
- RJ45 jacks for connection to additional PA-1120RC microphones with slave/priority switch
- Supplied with connection module for PA-1120 and PA-1240



PA-5000PTT

Order No. 0233260

PA desktop microphone (push-to-talk), e.g. for connection to PA-5240, PA-5480.

- Push-to-talk button with switching contact for activating the chime at the amplifier
- Connection via screw terminal
- Output for priority function



PA-4000PTT

Order No. 0236000

PA desktop microphone (push-to-talk), for connection to PA-40120 or PA-1120, PA-1240, PA-1414MX and the PA-6000 series.

- Automatic chime via microphone announcement button (talk)
- Chime can be activated and deactivated as required
- Power supply via connected amplifiers
- RJ45 jack for connection to suitable amplifiers
- Supplied with 3 m connection cable (Cat. 5e)

1 x PA-4000PTT only can be connected to each amplifier



PA-4300PTT

Order No. 0230980

PA desktop microphone (push-to-talk), for connection to PA-1120, PA-1240, PA-2420Z, PA-6010Z or PA-6020Z.

- Automatic chime via microphone announcement button (talk)
- Chime can be activated or deactivated as required
- LED indication for talk and busy
- Power supply via connected amplifier
- RJ45 jack for connecting additional PA-4300PTT with slave/priority switch

3 x PA-4300PTT can be connected to each amplifier



CLASSIC LINE

PA-1200

Order No. 0170710



4-zone mono PA mixing amplifier

- 1 x 120 W
- Silent operation due to fanless cooling concept
- Chime, continuous sound and wailing sound, automatic mute, chime can also be activated via external momentary push-button, 2-tone chime or 4-tone chime (selectable)
- Bass, treble and master controls, level display via LEDs
- 15 V phantom power for channels 2 and 3
- Insertions for various functions are available at option PA-1200RM, available at option
- Mains operation and 24 V emergency power operation

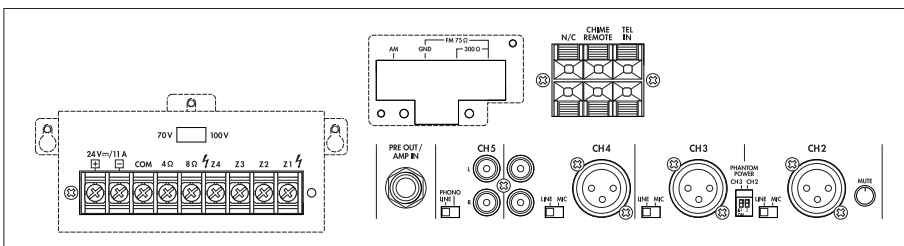

Model	PA-1200
Peak output power	170 W
Power rating	120 W
Inputs	1.5 mV/600 Ω (mic), 150 mV/47 kΩ (line), 1 mV/47 kΩ (phono)
Frequency range	80-15,000 Hz
Equalizer bass	± 10 dB/100 Hz
Equalizer treble	± 10 dB/10 kHz
S/N ratio	> 60 dB (mic), > 70 dB (line)
THD	< 1%
Power supply	~ 230 V/50 Hz/280 VA, = 24 V/11 A
Dimensions	420 x 122 x 350 mm
Weight	12.28 kg

PA-1200RM

Order No. 0126740



Mounting frame, for installation of PA mixing amplifier PA-1200 into a 482 mm (19") rack, black lacquered.
Inside dimensions: 420 x 290 mm, 3 RU



Audio Streaming Solutions with MondeF

Digital audio networks for everyone: Come and find out more about our new AoIP solution MondeF.

Start into the digital PA future now and become a certified MondeF partner.



www.monacor-international.com/mondef



PA-1140RCD

Order No. 0173530



RDS tuner/CD player insertion with USB interface, for PA mixing amplifiers with insertion compartment at the front.

- USB flash drive can be connected directly

FM/AM tuner section:

- RDS function for FM
- 24 station presets (18 x FM, 6 x AM)
- Digital display

- Station scanning
- CD player section:
- Anti-shock system
- Slot-in mechanism
- Random play, scan and repeat functions
- Display of track/time
- Shock-proof due to oil shock absorber
- Audio CD/CD-R/CD-RW/MP3 CD



PA-1200RDSU

Order No. 0175030



FM/AM RDS tuner insertion with USB interface, for PA mixing amplifiers with insertion compartment.

- RDS function for FM
- 24 station presets (FM: 3 x 6, AM: 1 x 6)
- Station scanning
- USB storage media can be connected directly

- Reproduction of MP3 files and WMA files
- Display of file name
- Easy folder navigation
- Alphanumeric LCD
- Auto restart after power failure
- Memory for settings and operating modes



PA-1120DMT

Order No. 0174580



Digital message and timer insertion, for PA mixing amplifiers with insertion compartment.

- Backlit DOT matrix display with 2 x 8 digits
- DCF77 synchronised clock (radio-controlled clock) for time-controlled announcements
- Internal memory for up to 26 audio files
- Audio files can be copied to the internal memory via integrated micro SD card reader
- 6 memory presets, to be accessed directly via buttons at the device or via zone paging microphone PA-1120RC or PA-6000RC and PA-1120DMT

- 3.5 mm connection on the front panel for picking up microphone signals or line signals
- Up to 20 daily events can be programmed



PA-24FMM

Order No. 0174660

Insertion module for emergency announcements, with integrated voice memory.

- For PA mixing amplifiers with insertion compartment
- Hand-held microphone with operational monitoring
- Alarm input for activation

- Integrated digital voice memory (60 seconds max.) with microphone input or line input for recording messages
- Automatic reproduction possible of a previously recorded voice message
- Siren emits an acoustic signal for 10 seconds when alarm is triggered
- Adjustable headphone connection

PA-1200EX

Order No. 0248160



Dual module extension, for all insertion modules of the PA series.

- For accepting up to 2 insertions
- XLR connection
- Mains operation or 24 V emergency power operation
- 482 mm (19") rack installation with fitted mounting brackets
- Dimensions without brackets: 425 x 88 x 380 mm, 2 RU
- Weight: 4.5 kg



CLASSIC LINE

PA-914D

Order No. 1000143



PA-928D

Order No. 1000146



PA-9100D

Order No. 1000149



Mono class D PA mixing amplifiers

- 1 x 140 W (PA-914D)
- 1 x 280 W (PA-928D)
- 1 x 1,000 W (PA-9100D)
- Class D concept with PASCAL amplifier module
- Energy-efficient concept due to high efficiency
- Lightweight design due to compact switch-mode power supply
- Silent operation due to fanless cooling concept
- 4 balanced mic/line inputs
- Mic 1 with priority circuit and automatic talkover
- Additional connection for desktop microphone via screw terminal
- 1 aux input
- Speaker outputs via screw terminals
- Line output
- Insert facility, e.g. for effect units, equalizers, feedback controllers
- Input level control and output level control
- 2-way tone control for the output
- 48 V phantom power for each microphone input, to be activated individually
- Limiter switch: 8 Ω/100 V
- Removable mounting brackets

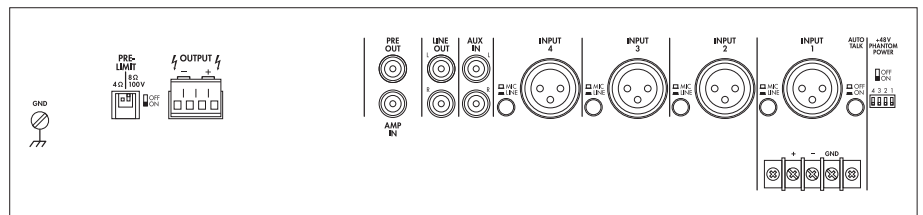

Model	PA-914D	PA-928D	PA-9100D
Power rating	140 W	280 W	1,000 W
Power rating at 8 Ω	140 W	280 W	1,000 W
Power rating at 100 V	140 W/66 Ω	280 W/33 Ω	1000 W/9.2 Ω
Output impedance	8 Ω	8 Ω	4-8 Ω
Inputs	3 mV (mic), 200 mV (line), 140 mV (aux)	3 mV (mic), 200 mV (line), 140 mV (aux)	3 mV (mic), 200 mV (line), 140 mV (aux)
Frequency range	20-20,000 Hz	20-20,000 Hz	20-20,000 Hz
Equalizer bass	± 10 dB/100 Hz	± 10 dB/100 Hz	± 10 dB/100 Hz
Equalizer treble	± 10 dB/10 kHz	± 10 dB/10 kHz	± 10 dB/10 kHz
S/N ratio	> 80 dB	> 80 dB	> 80 dB
THD	< 0.1%	< 0.1%	< 0.1%
Power supply	~ 90-230 V/50-60 Hz/160 VA	~ 90-230 V/50-60 Hz/300 VA	~ 90-230 V/50-60 Hz/1,100 VA
Dimensions	482 x 88 x 275 mm, 2 RU	482 x 88 x 275 mm, 2 RU	482 x 88 x 275 mm, 2 RU
Weight	5.1 kg	5.2 kg	5.6 kg

PA-948

Order No. 0175070



Mono PA mixing amplifier

- 1 x 480 W
- 4 balanced microphone inputs and line inputs with selectable priority
- 4 stereo line inputs
- Speaker outputs via screw terminal contacts
- Balanced line output
- Record output
- Insert facility, e.g. for effect units, equalizers, feedback controllers
- 2-tone or 4-tone chime, can be activated externally
- Input level control and output level control
- 2-way tone control for the output
- Switchable 48 V phantom power for microphone inputs



- Temperature-controlled fan
- Mains operation or 24 V emergency power operation
- Removable mounting brackets

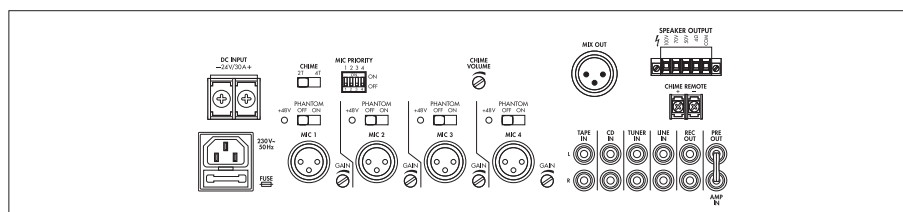

Model	PA-948
Peak output power	680 W
Power rating	480 W
Inputs	2.5-100 mV (mic), 350 mV (line)
Frequency range	50-16,000 Hz
Equalizer bass	± 10 dB/100 Hz
Equalizer treble	± 10 dB/10 kHz
S/N ratio	> 75 dB
THD	< 0.1%
Power supply	~ 230 V/50 Hz/1,090 VA, = 24 V/27 A
Dimensions	482 x 137 x 395 mm, 3 RS
Weight	19 kg

PA-924

Order No. 0175060



Mono PA mixing amplifier

- 1 x 240 W
- 4 balanced microphone inputs and line inputs with selectable priority
- 4 stereo line inputs
- Speaker outputs via screw terminal contacts
- Balanced line output
- Record output
- Insert facility, e.g. for effect units, equalizers, feedback controllers
- 2-tone or 4-tone chime, can be activated externally
- Input level control and output level control
- 2-way tone control for the output
- Switchable 48 V phantom power for microphone inputs
- Temperature-controlled fan
- Mains operation or 24 V emergency power operation
- Removable mounting brackets



Model	PA-924
Peak output power	340 W
Power rating	240 W
Inputs	2.5-100 mV (mic), 350 mV (line)
Frequency range	50-16,000 Hz
Equalizer bass	± 10 dB/100 Hz
Equalizer treble	± 10 dB/10 kHz
S/N ratio	> 75 dB
THD	< 0.1%
Power supply	~ 230 V/50 Hz/640 VA, = 24 V/18 A
Dimensions	482 x 95 x 390 mm, 2 RU
Weight	13 kg

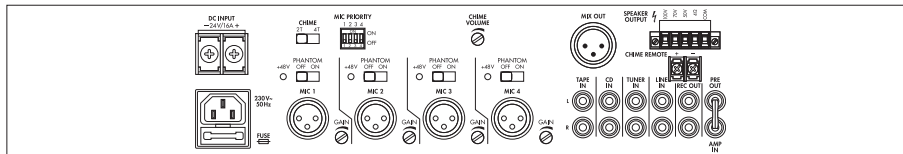

PA-900

Order No. 0171190



Mono PA mixing amplifier

- 1 x 120 W
- Silent operation due to fanless cooling concept
- 4 balanced mic/line inputs
- Mic 1 with priority circuit and automatic talkover
- Additional connection for desktop microphone via screw terminal
- 1 aux input
- Speaker outputs via screw terminals
- Line output
- Insert facility, e.g. for effect units, equalizers, feedback controllers
- Input level control and output level
- 2-way tone control for the output
- 20 V phantom power for each microphone input, to be activated individually
- Mains operation or 24 V emergency power operation
- Removable mounting brackets



Model	PA-900
Peak output power	160 W
Power rating	120 W
Output impedance	4 Ω
Inputs	3 mV (mic), 200 mV (line), 140 mV (aux)
Frequency range	50-15,000 Hz
Equalizer bass	± 10 dB/100 Hz
Equalizer treble	± 10 dB/10 kHz
S/N ratio	> 80 dB
THD	< 0.5%
Power supply	~ 230 V/50 Hz/300 VA, = 24 V/9 A
Dimensions	482 x 88 x 275 mm, 2 RU
Weight	9.9 kg

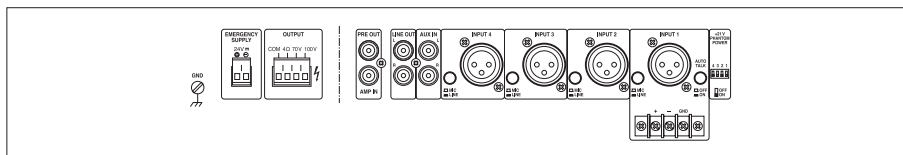

PA-8120RCD

Order No. 0173040



Mono PA mixing amplifier,

with integrated CD/MP3 player and radio.

- 1 x 120 W
- CD player with drawer mechanism, repeat function and random play, reproduction of audio CD/CD-R/CD-RW, MP3 CD, USB interface, separate on/off switch
- AM/FM radio module with 5 programmable station buttons, scan buttons, volume control and separate on/off switch
- 4 mic/line inputs, to be configured via DIP switches (mic/line, phase, high-pass filter, 48 V phantom power)
- 2 aux inputs, to be configured via DIP switches (aux1/aux2, 10 dB attenuation, high-pass filter)
- Siren function and chime function
- Priority circuit
- Speaker outputs via screw terminals
- Line output
- Insert facility, e.g. for effect units, equalizers, feedback controllers
- Input level control and output level control
- 2-way tone control for the output
- 482 mm (19") rack installation



Model	PA-8120RCD
Power rating	120 W
Inputs	1.8 mV/5 kΩ, 300 mV/5 kΩ (mic/line), 100 mV/10 kΩ (line)
Frequency range	50-16,500 Hz
Equalizer bass	± 10 dB/100 Hz
Equalizer treble	± 10 dB/10 kHz
S/N ratio	> 65 dB
THD	0.5%
Power supply	~ 230 V/50 Hz/365 VA
Dimensions	482 x 110 x 450 mm, 2 RU
Weight	10.5 kg

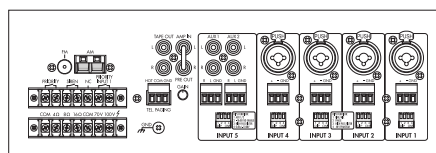



PA-324

Order No. 0174420



PA-312

Order No. 0173640



PA-306

Order No. 0176800



Mono PA mixing amplifiers

- 1 x 240 W (PA-324)
- 1 x 120 W (PA-312)
- 1 x 60 W (PA-306)
- Silent operation due to fanless cooling concept (with PA-312 and PA-306)
- 3 microphone inputs, one of which is a balanced input
- Mic 1/line 1 with adjustable input sensitivity, priority circuit and adjustable automatic talkover
- 2 stereo line inputs
- 1 telephone input for telephone systems with audio output
- Speaker outputs via screw terminals
- 1 line output
- Input level control and output level control
- 2-way tone control for the output
- 48 V phantom power for channel 1, can be activated as required
- 482 mm (19") rack installation with supplied mounting brackets

Model	PA-324	PA-312	PA-306
Peak output power	340 W	160 W	80 W
Power rating	240 W	120 W	60 W
Inputs	5 mV/600 Ω (mic), 350 mV/10 kΩ (aux), 1 V/10 kΩ (telephone)	5 mV/600 Ω (mic), 350 mV/10 kΩ (aux), 1 V/10 kΩ (telephone)	6 mV/600 Ω (mic), 310 mV/10 kΩ (aux), 1 V/10 kΩ (telephone)
Frequency range	50-16,000 Hz	50-16,000 Hz	50-16,000 Hz
Equalizer bass	± 10 dB/100 Hz	± 10 dB/100 Hz	± 10 dB/100 Hz
Equalizer treble	± 10 dB/10 kHz	± 10 dB/10 kHz	± 10 dB/10 kHz
S/N ratio	66 dB (mic) 80 dB (aux)	66 dB (mic) 80 dB (aux)	66 dB (mic) 80 dB (aux)
THD	< 0.5%	< 0.5%	< 0.5%
Power supply	~ 230 V/50 Hz/740 VA	~ 230 V/50 Hz/450 VA	~ 230 V/50 Hz/250 VA
Dimensions	430 x 88 x 380 mm, 2 RU	430 x 88 x 335 mm, 2 RU	430 x 88 x 335 mm, 2 RU
Weight	11.6 kg	7.8 kg	6.7 kg

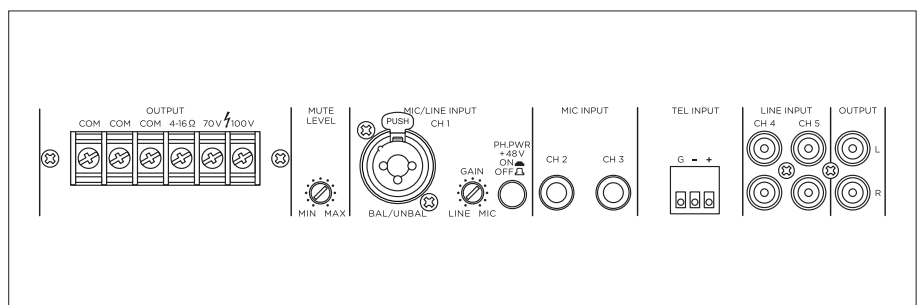

PA-704

Order No. 0179480



Mono PA mixing amplifier

- 1 x 35 W
- 2 low-impedance microphone inputs
- 1 aux input, 1 phono input
- Speaker outputs via screw terminals
- Input level control and output level control
- 2-way tone control for the output
- Connection for a microphone talk button to switch off the other sources during announcements
- Mains operation and 12-24 V emergency power operation



Model	PA-704
Peak output power	70 W
Power rating	35 W
Inputs	5 mV (mic), 210 mV (aux), 5 mV (phono)
Frequency range	100-18,000 Hz
Equalizer bass	±10 dB/150 Hz
Equalizer treble	±10 dB/6 kHz
S/N ratio	> 55 dB
THD	< 1%
Power supply	~ 230 V/50 Hz/100 VA = 12-24 V/2.5 A
Dimensions	320 x 85 x 230 mm
Weight	4.97 kg

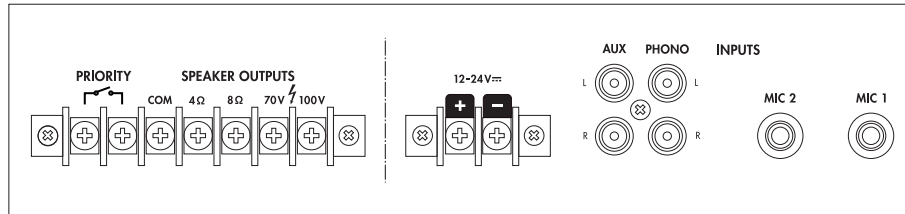

PA-812DAP

Order No. 1000235

PA-806DAP

Order No. 1000234

PA-803DAP

Order No. 1000168



Mono class D PA mixing amplifiers, with integrated

MP3 player, FM/DAB+ tuner and Bluetooth.

- 1 x 120 W (PA-812DAP)
- 1 x 60 W (PA-806DAP)
- 1 x 30 W (PA-803DAP)
- Class D concept with high efficiency to cut energy costs
- Silent operation due to fanless cooling concept
- Bluetooth version 4.2
- MP3 player with USB/SD interface, FM/DAB+ radio, LED display, infrared remote control
- Reception of interference-free 'digital radio' (DAB+)
- 1 balanced XLR microphone input with 48 V phantom power and priority selection for announcements
- 2 unbalanced inputs, switchable mic/line
- 2 unbalanced inputs
- 1 TEL input
- 1 Music-On-Hold output (MOH)
- Speaker outputs via screw terminals
- Mute function via screw terminal
- 1 amp input
- 1 preamp output
- Input level control and output level control
- 2-way tone control for the output
- LEDs for indicating operation, clipping, protect and signal level



Model	PA-812DAP	PA-806DAP	PA-803DAP
Power rating	120 W	60 W	30 W
Inputs	4.5 mV/600 Ω (channel 1), 4.5 mV/120 mV (channels 2-3), 60 mV (channels 4-5) 90 mV (tel.)	4.5 mV/600 Ω (channel 1), 4.5 mV/120 mV (channels 2-3), 60 mV (channels 4-5) 90 mV (tel.)	4.5 mV/600 Ω (channel 1), 120 mV (channels 2-3), 60 mV (channels 4-5) 90 mV (tel.)
Frequency range	60-15,000 Hz	60-15,000 Hz	60-15,000 Hz
Equalizer bass	yes	yes	yes
Equalizer treble	yes	yes	yes
S/N ratio	72 dB (mic, channels 1-3) 85 dB (line, channels 2-5)	72 dB (mic, channels 1-3) 85 dB (line, channels 2-5)	72 dB (mic, channels 1-3) 85 dB (line, channels 2-5)
THD	< 0.5%	< 0.5%	< 0.5%
Power supply	~ 230 V/50 Hz/250 VA = 24 V/8.4 A	~ 230 V/50 Hz/160 VA = 24 V/4.2 A	~ 230 V/50 Hz/100 VA = 24 V/2.5 A
Dimensions	320 x 95 x 245 mm	320 x 95 x 245 mm	320 x 95 x 245 mm
Weight	4.5 kg	4.1 kg	3.95 kg

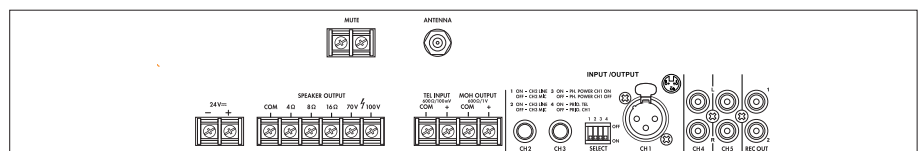

SPECIALS

MMA-130

Order No. 1000236



Mono class D PA mixing amplifier, 30 W/8 Ω.

- 1 microphone input and 1 line input, adjustable
- Line input each on the front panel and rear panel
- Bass and treble controls
- Mute switch
- LED indication for mute and operation
- Standard mounting dimensions (suitable for slots in motor vehicles)
- Power supply: = 12-24 V

Model	MMA-130
Power rating at 4 Ω	15 W
Power rating at 8 Ω	30 W
Inputs	1.9 mV/560 Ω (mic), 220 mV/4.8 kΩ (line)
Frequency range	20-20,000 Hz
Equalizer bass	± 12 dB
Equalizer treble	± 12 dB
THD	< 0.11%
Power supply	= 12-24 V/1.5 A
Dimensions	200 x 56 x 125 mm (dimensions of device) 178 x 48 x 112 mm (mounting dimensions)
Weight	724 g

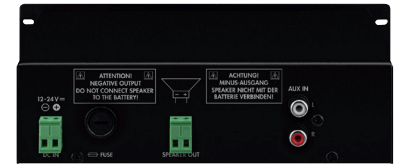
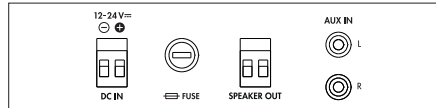

AKB-160

Order No. 0174260



PA amplifier module, with 100 V output.

- 1 x 40 W
- Silent operation due to fanless cooling concept
- Balanced line input (XLR) and unbalanced line input (RCA)
- Speaker output via screw terminal
- Volume control
- Metal housing with mounting brackets

Model	AKB-160
Peak output power	60 W
Power rating at 100 V	40 W
Inputs	390 mV/26 kΩ, bal. 420 mV/11 kΩ, unbal.
Frequency range	17-20,000 Hz
S/N ratio	> 80 dB
THD	< 1%
Power supply	~ 230 V/50 Hz/75 VA
Dimensions	213 x 55 x 238 mm
Weight	3.2 kg



**PROFESSIONAL
AUDIO OVER IP
SOLUTIONS**

**MONACOR-DT, practically
shaping up for the future ...**

Thanks to the DT series, Audio over IP solutions with Dante® interfaces can now conveniently be implemented at a very attractive price. Taking centre stage is the speaker **WALL-05DTM**.

MADE IN GERMANY
by MONACOR



MONACOR

Your Project is Our Project

PA-4240

Order No. 0170820



PA-4120

Order No. 0170810



PA power amplifiers

- 4 x 240 W (PA-4240)
- 4 x 120 W (PA-4120)
- Routing switches for parallel operation on 2 channels each
- Temperature-controlled fan
- Connection for external on/off switch
- LED indication for clip, protect, overtemperature and output level
- Mains operation or 24 V emergency power operation

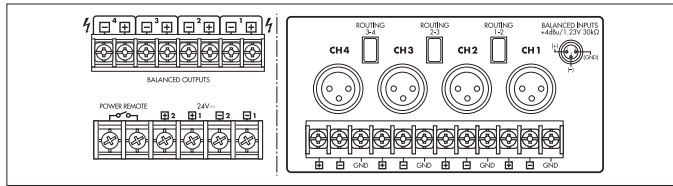

Model	PA-4240	PA-4120
Power rating	960 W	480 W
Power rating at 4 Ω	4 x 240 W	4 x 120 W
Power rating at 100 V	4 x 240 W	4 x 120 W
Output impedance	31 V/4 Ω, 50 V/10.4 Ω, 70 V/20 Ω, 100 V/42 Ω	22 V/4 Ω, 50 V/21 Ω, 70 V/41 Ω, 100 V/83 Ω
Inputs	1.2 V, bal.	1.2 V, bal.
Frequency range	55-17,000 Hz	55-17,000 Hz
S/N ratio	> 90 dBA	> 90 dBA
THD	< 1%	< 1%
Power supply	~ 230 V/50 Hz/2,720 VA, = 24 V/113 A	~ 230 V/50 Hz/1,400 VA, = 24 V/60 A
Dimensions	483 x 133 x 370 mm, 3 RU	483 x 133 x 370 mm, 3 RU
Weight	28 kg	25 kg

PA-2240

Order No. 0170800



PA power amplifier

- 2 x 240 W
- Routing switch for parallel operation on both channels
- Switchable 400 Hz high-pass filter 6 dB/oct.
- Soft start
- Temperature-controlled fan
- LED indication for clip, protect, overtemperature and output level
- Mains operation or 24 V emergency power operation

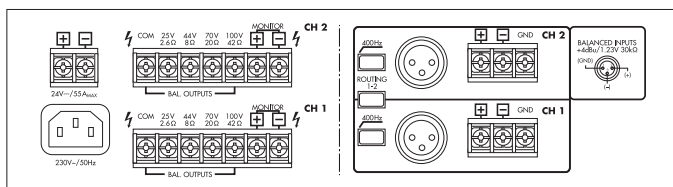

Model	PA-2240
Power rating	480 W
Power rating at 8 Ω	2 x 240 W
Power rating at 100 V	2 x 240 W
Output impedance	25 V/2.6 Ω, 44 V/8 Ω, 70 V/20 Ω, 100 V/42 Ω
Inputs	1.2 V, bal.
Frequency range	35-20,000 Hz
S/N ratio	> 100 dBA
THD	< 1%
Power supply	~ 230 V/50 Hz/1,300 VA, = 24 V/55 A
Dimensions	483 x 88 x 374 mm, 2 RU
Weight	18 kg

SINUS-220

Order No. 0174370



PA power amplifier, for application in professional PA systems and for setting up standardised voice alarm systems (VAS) according to EN 54-16 when combined with audio management system EVA-16 from MONACOR.

- 2 x 240 W
- Temperature-controlled fan
- LED indication for protect and signal
- Mains switch on the rear panel for preventing accidental switch-off
- 24 V emergency power input
- Mains operation or 24 V emergency power operation
- 482 mm (19") rack installation with fitted mounting brackets

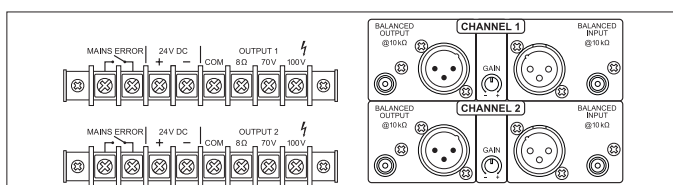

Model	SINUS-220
Power rating	480 W
Power rating at 8 Ω	2 x 240 W
Power rating at 100 V	2 x 240 W
Inputs	1 V/10 kΩ, bal.
Frequency range	35-18,000 Hz
S/N ratio	> 86 dB
Crosstalk attenuation	> 80 dB
THD	< 1%
Power supply	~ 230 V/50 Hz/1,280 W, = 24 V/30 A
Standby current	0.38 A
Dimensions	425 x 88 x 450 mm, 2 RU
Weight	18 kg

CLASSIC LINE

PA-1850D

Order No. 0172960



8-channel class D PA amplifier

- 8 x 50 W
- Class D concept with a high efficiency to cut energy costs
- Requires a lower rechargeable battery capacity for emergency power operation than 100 V analogue amplifiers
- Clearly reduced cooling requirements due to low heat dispersion
- Silent operation due to fanless cooling concept
- Mute function for each channel
- Level control for each channel
- LED indication for clip and protect for each channel pair
- Protected against short circuit
- Mains operation or 24 V emergency power operation

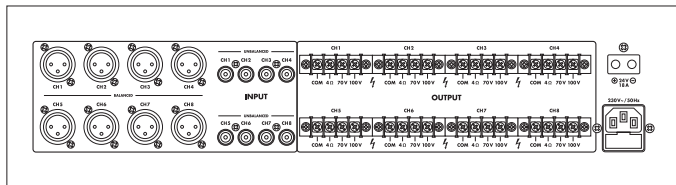

Model	PA-1850D
Power rating	400 W
Power rating at 4 Ω	8 x 50 W
Power rating at 100 V	8 x 50 W
Output impedance	4 Ω, 70/100 V
Inputs	1 V/20 kΩ unbal. 550 mV/20 kΩ bal.
Frequency range	10-20,000 Hz
S/N ratio	> 65 dB
THD	< 0.5%
Power supply	~ 230 V/50 Hz/600 VA, ~ 24 V/18 A
Dimensions	483 x 90 x 398 mm, 2 RU
Weight	18 kg

PA-1450D

Order No. 0172950



4-channel class D PA amplifier

- 4 x 50 W
- Class D concept with a high efficiency to reduce energy costs
- Requires lower rechargeable battery capacity for emergency power operation than 100 V analogue amplifiers
- Clearly reduced cooling requirements due to low heat dispersion
- Silent operation due to fanless cooling concept
- Mute function for each channel
- Level control for each channel
- LED indication for clip and protect for each channel pair
- Protected against short circuit
- Mains operation or 24 V emergency power operation

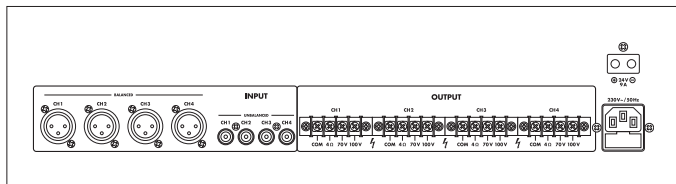

Model	PA-1450D
Power rating	200 W
Power rating at 4 Ω	4 x 50 W
Power rating at 100 V	4 x 50 W
Output impedance	4 Ω, 70/100 V
Inputs	1 V/20 kΩ unbal. 550 mV/20 kΩ bal.
Frequency range	10-20,000 Hz
S/N ratio	63 dB
THD	< 0.5%
Power supply	~ 230 V/50 Hz/300 VA, ~ 24 V/9 A
Dimensions	483 x 90 x 330 mm, 2 RU
Weight	11 kg

PA-4120D

Order No. 1000015



4-channel class D PA power amplifier

- 4 x 120 W
- Class D concept with a high efficiency to cut energy costs
- Temperature-controlled fan, continuously adjustable
- Connection for external on/off switch
- Connection for external mute switch
- LED indication for protect, peak, signal and 100 V/4 Ω operation

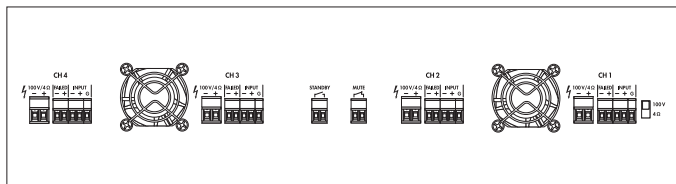

Model	PA-4120D
Power rating	480 W
Power rating at 4 Ω	4 x 120 W
Power rating at 100 V	4 x 120 W
Output impedance	100 V/83 Ω, 4 Ω
Inputs	775 mV/20 kΩ, bal.
Frequency range	80-16,000 Hz
S/N ratio	> 95 dBA
THD	< 0.1%
Power supply	~ 230 V/50 Hz/850 VA
Dimensions	483 x 52 x 320 mm, 1 RU
Weight	5.1 kg

PA-1960

Order No. 0172550



High-power mono PA amplifier

- 1 x 960 W
- Additional, adjustable priority input with switchable priority function
- 100 V slave input for inserting the amplifier into a 100 V speaker line
- Switchable 400 Hz high-pass filter 6 dB/oct.
- 2 insertion facilities on the rear panel for optional modules with the following features:
 - PA-6FD: fault detection module
 - PA-6FM: fault monitoring module
- Connection for external on/off switch (remote start)
- Temperature-controlled fan, continuously adjustable
- LED indication for fault, protect, clip, signal, priority
- Mains operation or 24 V emergency power operation

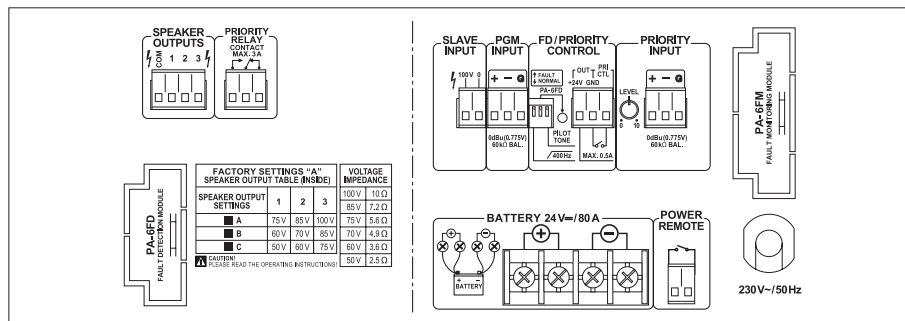

Model	PA-1960
Power rating	960 W
Power rating at 100 V	1 x 960 W
Output impedance	75 V/5.6 Ω, 85 V/7.2 Ω, 100 V/10 Ω
Inputs	0.775 V/60 kΩ, bal.
Frequency range	35-20,000 Hz
S/N ratio	> 100 dB
THD	< 0.4%
Power supply	~ 230 V/50 Hz/2,600 VA, = 24 V/80 A
Standby current	= 24 V
Dimensions	483 x 133 x 374 mm, 3 RU
Weight	25 kg

PA-1480

Order No. 0171110



Mono PA power amplifier

- 1 x 480 W
- Switchable 400 Hz high-pass filter 6 dB/oct.
- Temperature-controlled fan, continuously adjustable
- LED indication for clip, protect, overtemperature and output level
- Feed-through output (link)
- Mains operation or 24 V emergency power operation

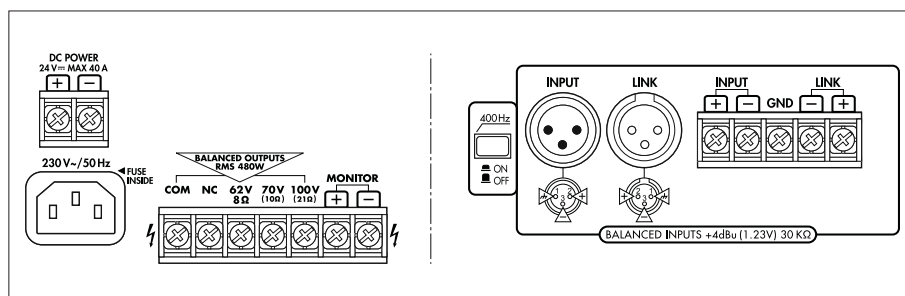

Model	PA-1480
Power rating	480 W
Power rating at 8 Ω	1 x 480 W
Power rating at 100 V	1 x 480 W
Output impedance	62 V/8 Ω, 70 V/10 Ω, 100 V/21 Ω
Inputs	1.2 V, bal.
Frequency range	35-20,000 Hz
S/N ratio	> 100 dBA
THD	< 1%
Power supply	~ 230 V/50 Hz/1,400 VA, = 24 V/40 A
Dimensions	483 x 88 x 374 mm, 2 RU
Weight	15.2 kg

PERFORMANCE LINE

PA-1250D

Order No. 0173860



Mono class D PA power amplifier, with an energy-saving effect.

- 1 x 250 W
- Class D concept with a high efficiency of more than 90% to cut energy costs
- Additional integrated energy-saving functions, e.g. device automatically goes to standby mode if no input signal is present (as soon as an input signal is detected, the amplifier will automatically restart)
- Requires a significantly lower rechargeable battery capacity for emergency power operation than 100 V analogue amplifiers
- Clearly reduced cooling requirements due to low heat dispersion



- Silent operation due to fanless cooling concept, thus especially suitable for noise-sensitive areas, e.g. offices, conference rooms or houses of worship
- Special protective circuits prevent damage caused by short circuit or overheating

- Extensive, menu-controlled settings
- Switchable 200 Hz high-pass filter, 6 dB/oct.
- Additional priority input
- LCD for the operating parameters
- Mains operation or 24 V emergency power operation

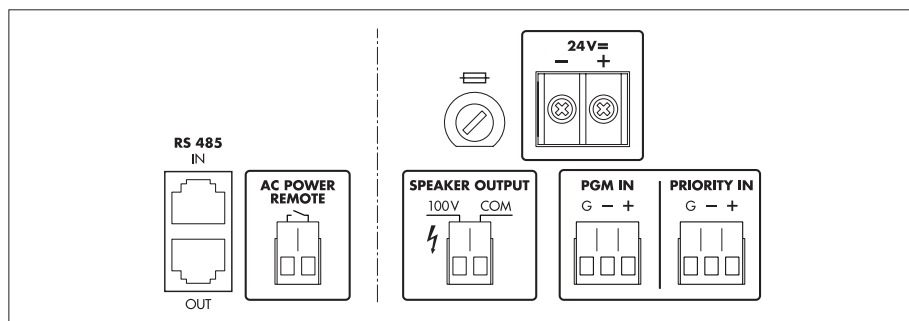

Model	PA-1250D
Peak output power	350 W
Power rating	250 W
Power rating at 100 V	1 x 250 W
Output impedance	100 V/40 Ω
Inputs	1.2 V, bal. (line)
Frequency range	50-18,000 Hz
S/N ratio	> 100 dBA
THD	< 0.5%
Power supply	~ 230 V/50 Hz/350 VA, 8 W (standby mode), = 24 V/20 A, 280 mA (standby mode)
Dimensions	482 x 88 x 410 mm, 2 RU
Weight	7.5 kg

SINUS-20

Order No. 0174240



SINUS-10

Order No. 0174230



PA power amplifiers, for application in professional PA systems and for setting up standardised voice alarm systems (VAS) according to EN 54-16 when combined with audio management system EVA-16 from MONACOR.

- 1 x 240 W (SINUS-20)
- 1 x 120 W (SINUS-10)
- Temperature-controlled fan
- LED indication for protect and signal
- Mains switch on the rear panel for preventing accidental switch-off
- 24 V emergency power input
- Mains operation or 24 V emergency power operation
- 482 mm (19") rack installation with fitted mounting brackets

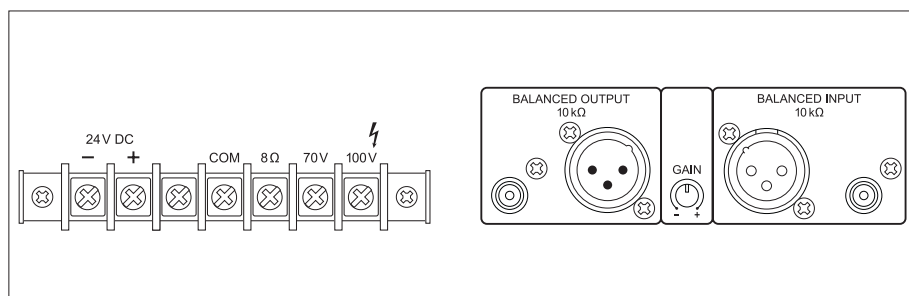

Model	SINUS-20	SINUS-10
Power rating	240 W	120 W
Power rating at 8 Ω	1 x 240 W	120 W
Power rating at 100 V	1 x 240 W	120 W
Inputs	1 V/10 kΩ, bal.	1 V/10 kΩ, bal.
Frequency range	35-18,000 Hz	35-18,000 Hz
S/N ratio	> 86 dB	> 86 dB
Crosstalk attenuation	> 80 dB	> 80 dB
THD	< 1%	< 1%
Power supply	~ 230 V/50 Hz/640 W, = 24 V/15 A	~ 230 V/50 Hz/320 W, = 24 V/7.5 A
Standby current	0.23 A	0.16 A
Dimensions	425 x 88 x 305 mm, 2 RU	425 x 88 x 305 mm, 2 RU
Weight	10.5 kg	8.5 kg



PA-900S

Order No. 0172080



Mono PA power amplifier

- 1 x 120 W
- Silent operation due to fanless cooling concept
- 2-way tone control
- Switchable low cut filter
- Speaker outputs via screw terminals

- Feed-through output (link)
- Mains operation or 24 V emergency power operation
- 482 mm (19") rack installation with supplied mounting brackets

Model	PA-900S
Peak output power	160 W
Power rating	120 W
Inputs	765 mV (line)
Frequency range	50-15,000 Hz
Equalizer bass	± 10 dB/100 Hz
Equalizer treble	± 10 dB/10 kHz
S/N ratio	> 80 dB
THD	< 0.5%
Power supply	~ 230 V/50 Hz/300 VA, = 24 V/9 A
Dimensions	482 x 88 x 275 mm, 2 RU
Weight	9.5 kg



MONACOR TALKSAFE

Maximum mobility with ideal speech intelligibility

- Non-contact, fully automatic intercom with impressive functionality
- Safe and clear communication for doctors' surgeries, pharmacies, petrol stations or hotels
- No complex installation necessary, suitable for simple retrofitting



MONACOR

Your Project is Our Project

BASIC LINE

PA-948S

Order No. 0177020



Mono PA power amplifier

- 1 x 480 W
- Temperature-controlled fan, continuously adjustable
- Protected against overheating, overload and short circuit
- LED indication for clip, protect, overtemperature, output level and 100 V/70 V
- Feed-through output (link)



- Speaker outputs via screw terminals

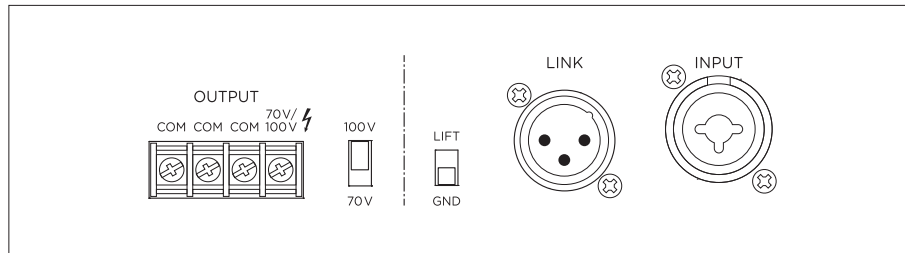

Model	PA-948S
Power rating	480 W
Power rating at 100 V	1 x 480 W
Output impedance	70 V/10 Ω, 100 V/20 Ω
Inputs	710 mV/10 kΩ, balanced
Frequency range	80-16,000 Hz
S/N ratio	> 98 dBA
THD	< 1%
Power supply	~ 230 V/50 Hz/1,100 VA
Dimensions	483 x 44 x 255 mm, 1 RU
Weight	4 kg

PA-924S

Order No. 0177010



Mono PA power amplifier

- 1 x 240 W
- Temperature-controlled fan, continuously adjustable
- Protected against overheating, overload and short circuit
- LED indication for clip, protect, overtemperature, output level and 100 V/70 V
- Feed-through output (link)



- Speaker outputs via screw terminals

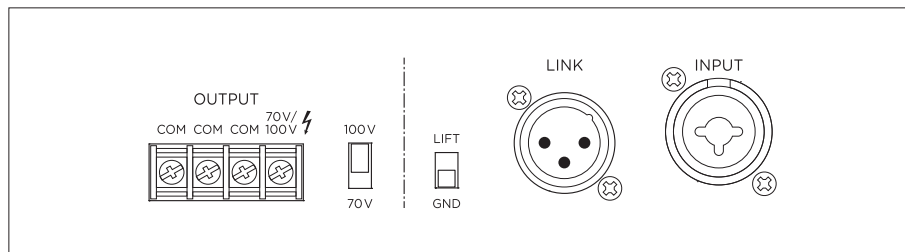

Model	PA-924S
Power rating	240 W
Power rating at 100 V	1 x 240 W
Output impedance	70 V/20 Ω, 100 V/40 Ω
Inputs	650 mV/10 kΩ, balanced
Frequency range	80-16,000 Hz
S/N ratio	> 98 dBA
THD	< 1%
Power supply	~ 230 V/50 Hz/495 VA
Dimensions	483 x 44 x 255 mm, 1 RU
Weight	3.8 kg

PA-912S

Order No. 0177000



Mono PA power amplifier

- 1 x 120 W
- Temperature-controlled fan, continuously adjustable
- Protected against overheating, overload and short circuit
- LED indication for clip, protect, overtemperature, output level and 100 V/70 V
- Feed-through output (link)
- Speaker outputs via screw terminals

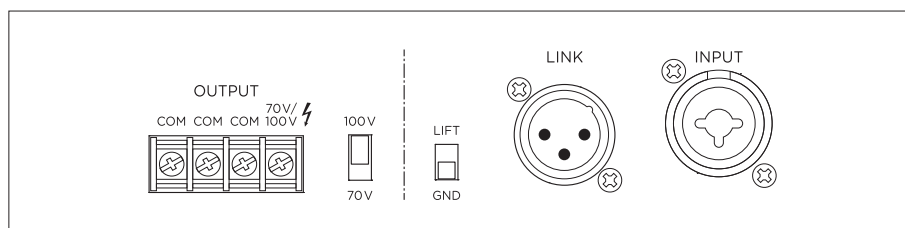

Model	PA-912S
Power rating	120 W
Power rating at 100 V	1 x 120 W
Output impedance	70 V/40 Ω, 100 V/80 Ω
Inputs	670 mV/10 kΩ, balanced
S/N ratio	> 98 dBA
THD	< 1%
Power supply	~ 230 V/50 Hz/225 VA
Dimensions	483 x 44 x 255 mm, 1 RU
Weight	3.5 kg



STA-1508

Order No. 0244300



STA-1506

Order No. 0244290



STA-1504

Order No. 0244280



Multi-channel PA amplifiers, with integrated limiter.

STA-1508 = 8 channels

STA-1506 = 6 channels

STA-1504 = 4 channels

- Balanced inputs
- High-pass filter, low-pass filter, can be activated as required for each channel
- Tamper-resistant level adjustment on the rear panel
- 8 Ω bridged operation possible
- LED VU meter and LED per channel for indicating overload (clip)
- Soft start
- Ground lift switch
- Speaker switch-on delay
- Fan cooling
- Protected against short circuit, overheating and DC voltage overlay at the outputs

Model	STA-1508	STA-1506	STA-1504
Peak output power	1,800 W	1,400 W	900 W
Power rating	1,280 W	960 W	640 W
Power rating at 4 Ω	8 x 160 W	6 x 160 W	4 x 160 W
Power rating at 8 Ω	8 x 100 W	6 x 100 W	4 x 100 W
Power rating with 8 Ω bridged operation	4 x 320 W	3 x 320 W	2 x 320 W
Inputs	0.7 V/20 kΩ	0.7 V/20 kΩ	0.7 V/20 kΩ
Frequency range	12-20,000 Hz	12-20,000 Hz	12-20,000 Hz
Crossover frequency	240 Hz	240 Hz	240 Hz
S/N ratio	> 80 dB	> 80 dB	> 80 dB
Crosstalk attenuation	> 60 dB	> 60 dB	> 60 dB
THD	< 0.1%	< 0.1%	< 0.1%
Power supply	~ 230 V/50 Hz/2,400 VA	~ 230 V/50 Hz/1,800 VA	~ 230 V/50 Hz/1,200 VA
Dimensions	482 x 132 x 310 mm, 3 RU	482 x 132 x 310 mm, 3 RU	482 x 132 x 310 mm, 3 RU
Weight	16.6 kg	15.5 kg	14 kg

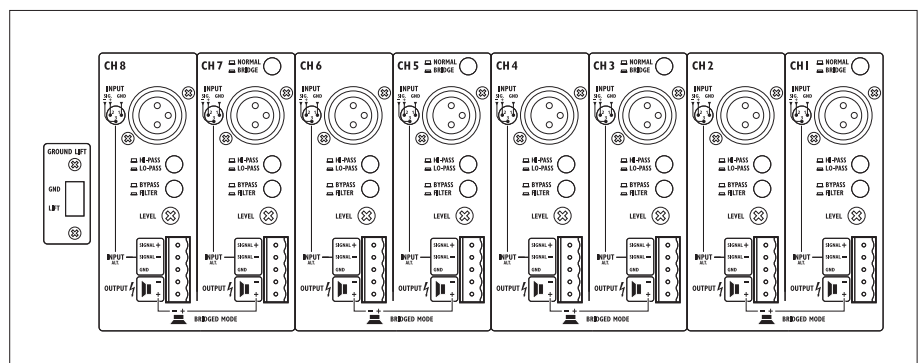

CLASSIC LINE

STA-2000D

Order No. 0255220

482mm 19" 2400W 4Ω 8Ω

4-channel class D PA amplifier, 2,400 W

- Class D concept with power amplifier modules from PASCAL
- Excellent acoustic performance
- Extra wide dynamic range with very low THD
- Excellent pulse response also in the bass range
- 482 mm (19") rack installation, 2 RU
- 2 or 4 channels in bridged mode
- 100 V line technique possible in bridged operation
- Silent operation due to temperature-controlled fans, only activated if temperature rises above 85 °C



PASCAL

- Lightweight design due to compact switch-mode power supply
- Energy-efficient concept due to a high efficiency
- 4 level controls
- Protected against short circuit, overtemperature, DC voltage at the output and overload

Model	STA-2000D
Peak output power	2,400 W
Power rating	2,000 W
Power rating at 4 Ω	4 x 500 W
Power rating at 8 Ω	4 x 280 W
Power rating with 4 Ω bridged operation	2 x 1,000 W
Power rating with 8 Ω bridged operation	2 x 1,000 W
Inputs	1 V/10 kΩ (XLR, bal), 1 V/5 kΩ (RCA)
Frequency range	20-20,000 Hz
S/N ratio	> 119 dBA
THD	< 0.05%
Power supply	~ 85-265 V/50 Hz/2,320 VA
Dimensions	482 x 89 x 335 mm, 2 RU
Weight	6.4 kg

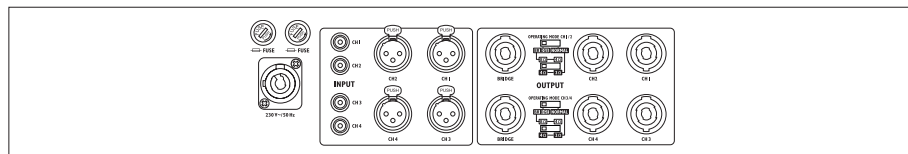

STA-850D

Order No. 0252360

482mm 19" 600W 4Ω 8Ω

8-channel class D amplifier

- Silent operation due to fanless cooling concept
- 8 Ω bridged operation possible
- Mute function for each channel
- 8 level controls
- 1 LED per channel for indicating overload (clip)
- Protected against short circuit



Model	STA-850D
Peak output power	600 W
Power rating	400 W
Power rating at 4 Ω	8 x 50 W
Power rating at 8 Ω	8 x 30 W
Power rating with 8 Ω bridged operation	4 x 100 W
Inputs	1 V/20 kΩ unbal. 550 mV/20 kΩ bal.
Frequency range	10-20,000 Hz
Crosstalk attenuation	> 45 dB
Power supply	~ 230 V/50 Hz/600 VA
Dimensions	483 x 90 x 330 mm, 2 RU
Weight	10.5 kg

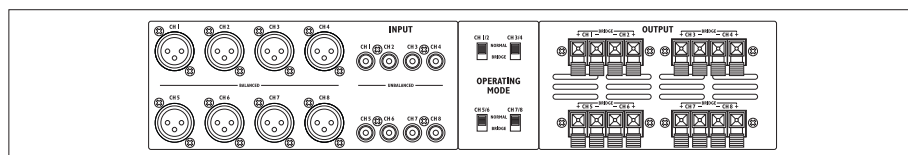

STA-450D

Order No. 0252350

482mm 19" 300W 4Ω 8Ω

4-channel class D amplifier

- Silent operation due to fanless cooling concept
- 8 Ω bridged operation possible
- Mute function for each channel
- 4 level controls
- 1 LED per channel for indicating overload (clip)
- Protected against short circuit



Model	STA-450D
Peak output power	300 W
Power rating	200 W
Power rating at 4 Ω	4 x 50 W
Power rating at 8 Ω	4 x 30 W
Power rating with 8 Ω bridged operation	2 x 100 W
Inputs	1 V/20 kΩ unbal. 550 mV/20 kΩ bal.
Frequency range	10-20,000 Hz
Crosstalk attenuation	> 45 dB
Power supply	~ 230 V/50 Hz/300 VA
Dimensions	483 x 90 x 330 mm, 2 RU
Weight	8.4 kg

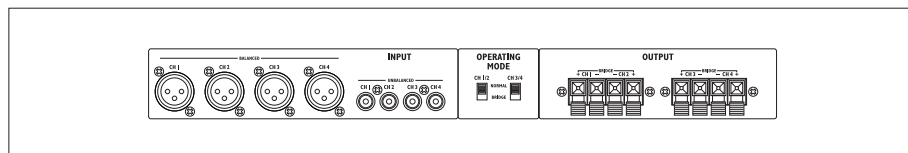

STA-1000D

Order No. 0255210



Stereo class D PA amplifier, 1,200 W

- Class D concept with power amplifier modules from PASCAL
- Excellent acoustic performance
- Extra wide dynamic range with very low THD
- Excellent pulse response also in the bass range
- 482 mm (19") rack installation, 2 RU
- Silent operation due to temperature-controlled fans, only activated if temperature rises above 85 °C
- Lightweight design due to compact switch-mode power supply
- Energy-efficient concept due to a high efficiency
- 2 level controls
- Protected against short circuit, overtemperature, DC voltage at the output and overload
- LEDs for indicating power, signal, bridge, overload (clip), overheating and protect
- Bridged operation
- 100 V line technique possible in bridged operation
- Wide mains voltage range: ~ 85-265 V
- NEUTRIK POWERCON and SPEAKON connections

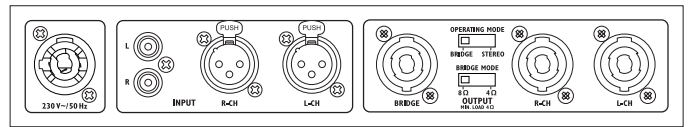

Model	STA-1000D
Peak output power	1,200 W
Power rating at 4 Ω	2 x 500 W
Power rating at 8 Ω	2 x 280 W
Power rating with 4 Ω bridged operation	1 x 1,000 W
Power rating with 8 Ω bridged operation	1 x 1,000 W
Inputs	1 V/10 kΩ (XLR, bal), 1 V/5 kΩ (RCA)
Frequency range	20-20,000 Hz
S/N ratio	> 119 dBA
THD	< 0.05%
Power supply	~ 230 V/50 Hz/1,160 VA
Dimensions	482 x 89 x 335 mm, 2 RU
Weight	5 kg

STA-800D

Order No. 0255200



Stereo class D PA amplifier

- Class D concept with power amplifier modules from HYPEx
- Silent operation due to temperature-controlled fans
- Lightweight design due to compact switch-mode power supply
- Energy-efficient concept due to a high efficiency
- High power reserves due to the application of two switch-mode power supplies
- Powerful bass reproduction due to large buffer capacitors (high power reserves)
- 2 level controls
- Protected against short circuit and overtemperature
- LEDs for indicating power, overload (clip) and protect
- Super slimline design
- NEUTRIK SPEAKON connections

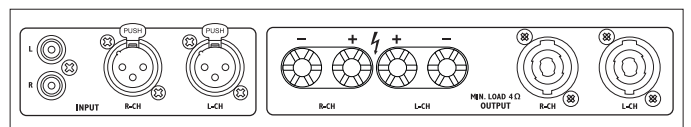

Model	STA-800D
Peak output power	1,000 W
Power rating	800 W
Power rating at 4 Ω	2 x 400 W
Power rating at 8 Ω	2 x 210 W
Inputs	1 V/10 kΩ (XLR, bal), 1 V/4.7 kΩ (RCA)
Frequency range	20-20,000 Hz
S/N ratio	> 110 dBA
THD	< 0.004%
Power supply	~ 230 V/50 Hz/920 VA
Dimensions	482 x 52 x 298 mm, 1 RU
Weight	4 kg

STA-400D

Order No. 0255190



Stereo class D PA amplifier

- Class D concept with power amplifier modules from HYPEx
- Silent operation due to temperature-controlled fans
- Energy-efficient concept due to a high efficiency
- Powerful bass reproduction due to large buffer capacitors (high power reserves)
- 2 level controls
- Protected against short circuit and overtemperature
- LEDs for indicating power, overload (clip) and protect
- NEUTRIK SPEAKON connections

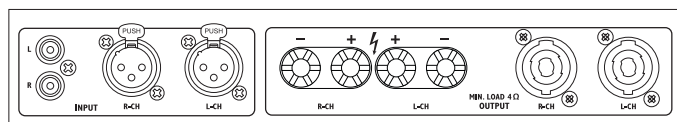

Model	STA-400D
Peak output power	700 W
Power rating	540 W
Power rating at 4 Ω	2 x 270 W
Power rating at 8 Ω	2 x 180 W
Inputs	1 V/10 kΩ (XLR, bal), 1 V/4.7 kΩ (RCA)
Frequency range	20-20,000 Hz
S/N ratio	> 110 dBA
THD	< 0.02%
Power supply	~ 230 V/50 Hz/600 VA
Weight	3.5 kg

CLASSIC LINE

STA-300D

Order No. 0257330



Stereo class D PA amplifier

- 2 operating modes can be selected (stereo or bridged)
- Limiter function can be activated as required
- 2 level controls
- Temperature-controlled fan
- Protective circuit with LED indication for protection against short circuit, overheating and DC voltage overlay at the outputs
- Each channel with LEDs for indicating overload (clip) and signal

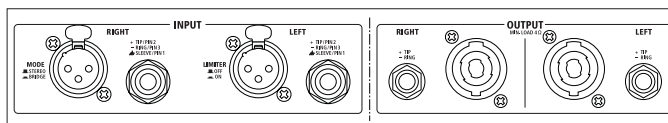

Model	STA-300D
Peak output power	350 W
Power rating	300 W
Power rating at 4 Ω	2 x 150 W
Power rating at 8 Ω	2 x 100 W
Power rating with 8 Ω bridged operation	1 x 300 W
Inputs	1 V/12 kΩ
Frequency range	20-20,000 Hz
S/N ratio	> 96 dB
Crosstalk attenuation	> 70 dB
THD	< 0.05%
Power supply	~ 230 V/50 Hz/510 VA
Dimensions	482 x 52 x 290 mm, 1 RU
Weight	3.7 kg

STA-200D

Order No. 0255070



Stereo class D PA amplifier, 250 W

- 5 switchable line inputs
- Silent operation due to fanless cooling concept
- High power reserves due to generously dimensioned toroidal core transformer
- High-efficiency power amplifiers
- 3.5 mm stereo jack connection with switchable sensitivity on the front panel
- 4 x RCA input
- 2 x SPEAKER output
- 4 x terminal strip output
- 2 level controls
- Protected against short circuit, overvoltage and overtemperature
- LEDs for indicating power, overload (clip), protect and overheating
- Super slimline and robust design, 1 RU

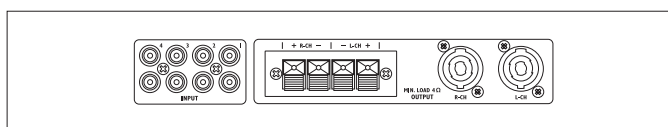

Model	STA-200D
Peak output power	300 W
Power rating	250 W
Power rating at 4 Ω	2 x 125 W
Power rating at 8 Ω	2 x 75 W
Inputs	1 V/23 kΩ (RCA), 90 mV-1 V (jack)
Frequency range	20-20,000 Hz
S/N ratio	> 100 dBA
Crosstalk attenuation	> 56 dB
THD	< 0.05%
Power supply	~ 230 V/50 Hz/350 VA
Dimensions	483 x 44 x 268 mm, 1 RU
Weight	5 kg

STA-235

Order No. 0253210



STA-225

Order No. 0253340



Stereo PA amplifiers, with integrated limiter.

- LCD for indicating temperature, operating mode, power
- 2 operating modes can be selected (stereo or bridged)
- Limiter function can be activated as required
- Temperature-controlled fans
- 2 level controls
- Ground lift function
- Speaker switch-on delay
- Protective circuit with LED indication for protection against short circuit and overheating
- Each channel with LEDs for indicating overload, level and signal

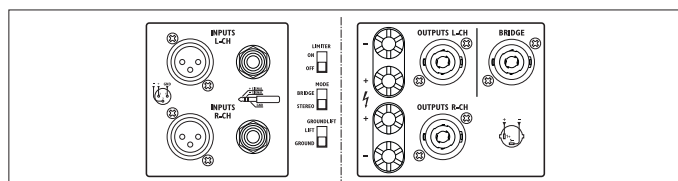

Model	STA-235	STA-225
Peak output power	1,400 W	1,000 W
Power rating	1,000 W	700 W
Power rating at 4 Ω	2 x 500 W	2 x 350 W
Power rating at 8 Ω	2 x 400 W	2 x 250 W
Power rating with 8 Ω bridged operation	1 x 1,000 W	1 x 700 W
Inputs	1.2 V/10 kΩ	1.3 V/10 kΩ
Frequency range	10-50,000 Hz	10-50,000 Hz
S/N ratio	> 80 dB	> 80 dB
Crosstalk attenuation	> 50 dB	> 50 dB
THD	< 0.1%	< 0.1%
Power supply	~ 230 V/50 Hz/2,000 VA	~ 230 V/50 Hz/1,500 VA
Dimensions	482 x 100 x 330 mm, 2 RU	482 x 100 x 330 mm, 2 RU
Weight	11.5 kg	10.3 kg

SA-200

Order No. 0257510



Universal stereo amplifier, 100 W

- Silent operation due to fanless cooling concept
- Stereo line input
- Speaker connection via terminal strip
- LEDs for indicating overload (clip)
- Volume control
- 482 mm (19") rack installation, 1 RU, with supplied mounting brackets

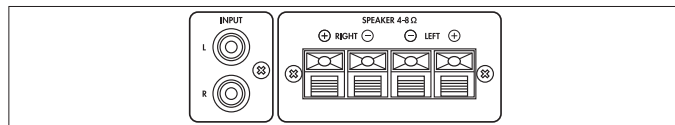

Model	SA-200
Peak output power	2 x 100 W
Power rating	100 W
Power rating at 4 Ω	2 x 50 W
Power rating at 8 Ω	2 x 30 W
Inputs	420 mV/6 kΩ
Frequency range	20-20,000 Hz
S/N ratio	> 83 dB
Power supply	~ 230 V/50 Hz/210 VA
Dimensions	431 x 55 x 255 mm
Weight	4.4 kg

SA-250/SW

Order No. 0253390



SA-230/SW

Order No. 0250740



Universal stereo mixing amplifiers

- Silent operation due to fanless cooling concept
- 3 stereo line inputs
- 3 mono microphone inputs on the front panel, each with gain control
- Adjustable digital echo for the microphone inputs
- Karaoke feature
- Vocal partner feature

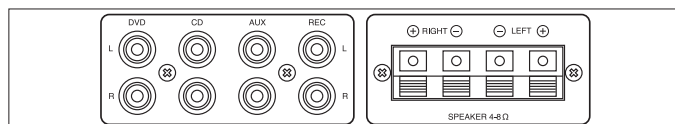

Model	SA-250/SW	SA-230/SW
Peak output power	2 x 100 W	2 x 50 W
Power rating	100 W	50 W
Power rating at 4 Ω	2 x 50 W	2 x 25 W
Power rating at 8 Ω	2 x 30 W	2 x 20 W
Inputs	175 mV/8 kΩ (line) 2.5 mV/3.5 kΩ (mic)	175 mV/8 kΩ (line) 2.5 mV/3.5 kΩ (mic)
Frequency range	20-20,000 Hz	20-20,000 Hz
Equalizer bass	± 10 dB	± 10 dB
Equalizer treble	± 10 dB	± 10 dB
S/N ratio	62 dB	62 dB
Power supply	~ 230 V/50 Hz/210 VA	~ 230 V/50 Hz/150 VA
Dimensions	432 x 45 x 275 mm	432 x 45 x 275 mm
Weight	4.5 kg	3.8 kg

SA-130DMP

Order No. 0257760



Stereo amplifier, 140 W with integrated MP3 player, Bluetooth receiver, FM radio and USB interface.

- Bluetooth receiver for wireless connection of laptops, smartphones or tablet PCs
- Adjustable microphone input and aux input on the front panel
- Adjustable stereo line input
- Insert facility, e.g. for effect units, equalizers, feedback controllers
- 2-way tone control
- Adjustable master output

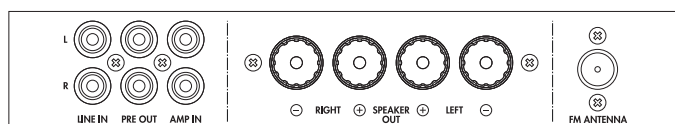

Model	SA-130DMP
Power rating	140 W
Power rating at 4 Ω	2 x 70 W
Inputs	480 mV/20 kΩ (line) 1.3 mV/500 Ω (mic) 190 mV/10 kΩ (aux) 580 mV/22 kΩ (amp in)
Frequency range	20-20,000 Hz
Equalizer bass	± 12 dB/100 Hz
Equalizer treble	± 10 dB/10 kHz
S/N ratio	90 dB
THD	0.1%
Power supply	~ 230 V/50 Hz/350 VA
Dimensions	482 x 44 x 245 mm
Weight	4.9 kg

SPECIALS

SA-100

Order No. 0254120

2x 50W 4Ω 8Ω

Compact universal stereo amplifier, 50 W

- Silent operation due to fanless cooling concept
- Additional 3.5 mm connection with switchable sensitivity on the front panel
- USB port on the front panel for power supply and for charging external devices
- Audio source selector switch
- Controls for volume, bass and treble
- 6.3 mm headphone output
- Robust metal housing

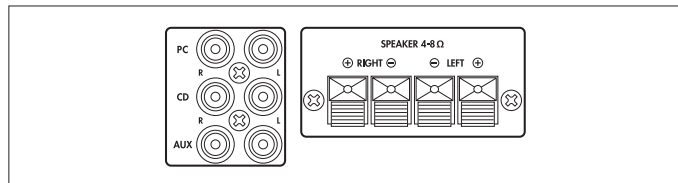

Model	SA-100
Peak output power	2 x 50 W
Power rating	50 W
Power rating at 4 Ω	2 x 25 W
Power rating at 8 Ω	2 x 20 W
Inputs	140 mV/46 kΩ (PC, CD, aux) 140 mV/12 kΩ, 25 mV/32 kΩ (player)
Frequency range	20-20,000 Hz
Equalizer bass	± 12 dB
Equalizer treble	± 12 dB
S/N ratio	> 70 dB
Power supply	~ 230 V/50 Hz/150 VA
Dimensions	212 x 56 x 250 mm
Weight	2.6 kg

SA-50

Order No. 0254620

2x 25W 4Ω 8Ω

Compact universal stereo amplifier, 25 W

- Silent operation due to fanless cooling concept
- Additional 3.5 mm connection with switchable sensitivity on the front panel
- Audio source selector switch
- Controls for volume, bass and treble
- 6.3 mm headphone output
- Robust metal housing

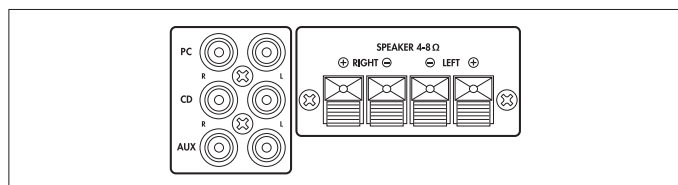

Model	SA-50
Peak output power	2 x 25 W
Power rating	25 W
Power rating at 4 Ω	2 x 12.5 W
Power rating at 8 Ω	2 x 10 W
Inputs	115 mV/12 kΩ (PC), 115 mV/12 kΩ (CD), 115 mV/12 kΩ (aux), 115 mV/12 kΩ (player, high), 20 mV/32 kΩ (player, low)
Frequency range	20-20,000 Hz
Equalizer bass	± 12 dB
Equalizer treble	± 12 dB
S/N ratio	> 65 dB
Power supply	~ 230 V/50 Hz/50 VA
Dimensions	212 x 56 x 200 mm
Weight	1.8 kg

SA-160BT

Order No. 0256010

2x 60W BT 8Ω

Mini stereo amplifier, 2 x 30 W, with Bluetooth interface, NFC and remote control.

- Integrated hi-fi audio amplifier
- For speakers with an impedance of 8 Ω
- Volume control with integrated source selector function, LED indicator
- Near Field Communication (NFC)
- Gold-plated speaker terminals
- 1 stereo input via RCA jacks L/R
- 1 line output via 3.5 mm stereo jack
- Fixed antenna
- Metal housing
- Power is provided via enclosed power supply



Model	SA-160BT
Peak output power	2 x 60 W
Power rating	60 W
Power rating at 8 Ω	2 x 30 W
Inputs	660 mV/10 kΩ
Frequency range	20-20,000 Hz
S/N ratio	> 99 dBA
Power supply	via encl. power supply
Standby current	100 mA
Dimensions	150 x 49 x 122 mm
Weight	610 g
Connections	1 x RCA L/R (line), 4 x spring-load. speaker term.(speakers)

IWA-05BT/WS

Order No. 0179000



Flush-mounted module with Bluetooth audio receiver/amplifier

- Total amplifier output power: 5 W
- Selectable operating modes: stereo or mono
- Can be linked with any device featuring Bluetooth (A2DP/AVRCP)
- Bluetooth BT2.1+EDR, class 2, operating range: 10 m
- Additional audio input (3.5 mm jack)
- Speaker connection is made via screw terminals
- Flush mounting into standard wall boxes from Ø 45 mm on

Model	IWA-05BT/WS
Peak output power	5 W
Power rating	5 W
Frequency range	45-20,000 Hz
S/N ratio	> 58 dB
Power supply	via encl. power supply
Power consumption, standby	≈ 0.6 W
Standby current	≈ 30 mA
Weight	74 g
Connections	speaker terminal, audio (3.5 mm jack)

- Supplied with receiver unit, flush-mounted frame/cover frame, power supply



IWA-50WIFI/WS

Order No. 0179020



Hi-fi multi-room amplifier, with Wi-Fi and Bluetooth.

- Integrated class D amplifier 2 x 25 W
- 3 audio sources: Wi-Fi, Bluetooth and AUX
- Multi-room features
- Supports streaming services such as Pandora, YouTube or Spotify
- App 'D-Stream Air' from Skideev available for iOS devices
- App 'AllPlay Jukebox' available for Android devices
- Wi-Fi configuration via WPS or individual web interface
- Integrated Wi-Fi antenna
- LAN connection jack; Wi-Fi will automatically be deactivated when connected
- Bluetooth version 4.0 (A2DP, AVRCP), class 2, operating range: up to 10 m

Model	IWA-50WIFI/WS
Power rating	2 x 25 W
Power rating at 4 Ω	2 x 10 W @ ≈ 12 V 2 x 16 W @ ≈ 15 V
Power rating at 8 Ω	2 x 6 W @ ≈ 12 V 2 x 10 W @ ≈ 15 V 2 x 25 W @ ≈ 24 V
Frequency range	45-20,000 Hz
Power supply	optionally: ≈ 12 V/30 W, ≈ 15 V/45 W, ≈ 24 V/60 W
Dimensions	175 x 100 x 37 mm
Weight	176 g
Connections	RJ45 (LAN) 3.5 mm jack (AUX) screw terminal (speakers, power supply)

- Power is provided via optional DC power supply 12 V, 15 V or 24 V



IWA-50U/SW

Order No. 0179010

Flush-mounted box for IWA-50WIFI/WS

- For wall mounting or flush mounting hi-fi multi-room amplifier IWA-50WIFI/WS
- Rectangular design
- Black plastic



AKB-90WIFI

Order No. 0320090



Hi-fi multi-room amplifier (WLAN), 2 x 45 W

- WLAN standard 802.11 B/G/N, 2.4 GHz
- System is set up via integrated webserver
- Multi-room function
- Integrated digital hi-fi audio amplifier (class D), suitable for speakers with an impedance of 4-8 Ω
- Network streaming via DLNA
- Supported audio formats: MP3, WMA, AAC/AAC+, ALAC, FLAC, APE, WAV
- Network protocols: TCP/IP, RDP, HTTP, UPNP
- Gold-plated speaker terminals

Model	AKB-90WIFI
Power rating	90 W
Power rating at 4 Ω	2 x 45 W
Frequency range	20-20,000 Hz
S/N ratio	> 98 dB
Power supply	via encl. power supply
Weight	750 g
Connections	speaker terminal LR

- Antenna with SMA antenna connection
- Aluminium housing with mounting flange
- Power is provided via enclosed power supply



SPECIALS

AKB-60

Order No. 0320740

60W 4Ω 8Ω

Active speaker module, mono, 45 W at 4 Ω

- Active module for activating passive speakers
- Line input via XLR or RCA
- Adjustable master output
- Very well-suited as a measuring amplifier of acoustic analysers
- Fanless concept with large heat sink

Model	AKB-60
Peak output power	60 W
Power rating	45 W
Power rating at 4 Ω	45 W
Power rating at 8 Ω	30 W
Inputs	0.4 V/20 kΩ bal., 11 kΩ unbal.
Frequency range	15-50,000 Hz
S/N ratio	> 80 dB
THD	< 0.01%
Power supply	~ 230 V/50 Hz/90 VA
Dimensions	212 x 52 x 190 mm
Weight	2.2 kg
Connections	1 x XLR input, bal., 1 x RCA L/R (input), speaker cable (4-8 Ω)



PA-302

Order No. 0171270

4Ω 8Ω 16Ω

Mono PA mixing amplifier, 14 W.

- 1 microphone input and 1 line input, adjustable
- 2 speaker outputs, switchable
- Built-in speaker
- Can also be operated as an intercom system
- Supplied with hand-held push-to-talk microphone
- Siren and fog horn, automatic fog horn
- Metal housing
- Supplied with mounting brackets
- 12/24 V battery operation, automatic switching

Model	PA-302
Peak output power	20 W
Power rating	14 W
Inputs	3 mV (mic), 50 mV (line)
Frequency range	20-20,000 Hz
S/N ratio	65 dB
THD	< 0.5%
Power supply	= 12-15 V/2 A, = 24 V/1 A
Dimensions	175 x 60 x 170 mm
Weight	1.4 kg
Connections	1 x 6.3 mm jack (mic input), 1 x RCA (line input), 2 x 2-pole screw terminal (speakers), 1 x 3-pole screw terminal with jumper (external speakers)



PA-102

Order No. 0172970

4Ω

Mono PA mixing amplifier, 8.5 W

- 1 adjustable microphone input
- 1 adjustable line input
- Supplied with hand-held push-to-talk microphone
- Siren function via push-button
- Metal housing
- Supplied with mounting brackets
- 12 V battery operation

Model	PA-102
Peak output power	15 W
Power rating	8.5 W
Inputs	3.4 mV/2.2 kΩ (mic), 240 mV/11 kΩ (line)
Frequency range	20-20,000 Hz
S/N ratio	70 dB
THD	< 0.3%
Power supply	= 12 V/2 A
Dimensions	151 x 41 x 115 mm
Weight	410 g
Connections	1 x 6.3 mm jack (mic input), 1 x RCA L/R (line input), screw terminal (speakers), screw terminal (power supply)



PAM-10

Order No. 0170150

4Ω 8Ω 16Ω

PA amplifier, with zone paging microphone.

- Integrated amplifier 10 W
- Talk button and volume control, speaker connection 4-16 Ω
- Power supply: ~ 230 V/50 Hz/12 VA
- Dimensions: 167 x 65 x 130 mm
- Mains operation



ICM-20H

Order No. 0174970

Intercom system, cable-connected, consisting of desktop microphone and separate call station. Ideally suited, e.g. for reception desks and sales counters.

Desktop microphone:

- 300 mm gooseneck, removable (XLR connection)
- Electret microphone cartridge, cardioid polar pattern
- Built-in amplifier and speaker
- Volume control
- Push-to-talk button
- Headphone connection (3.5 mm jack) with automatic switch-off of the built-in speaker
- Power is provided via enclosed power supply
- Dimensions console housing: 115 x 65 x 170 mm

Call station:

- Built-in speaker and microphone
- Call button (buzzer)
- 3 m connection cable for connection to desktop microphone
- Supplied with mounting accessories for attachment to glass panels
- Power supply via desktop microphone
- Dimensions: Ø 85 mm x 35 mm



Safe and clear communication despite protective screens, acrylic glass panels, splash guards and hygiene walls

Since the COVID-19 pandemic outbreak, screens made of safety glass or acrylic glass equally protect staff, patients and customers.

The TALKSAFE ensures clear and intelligible communication at checkouts, information desks, etc. despite protective measures, safety distance, hygiene walls and face masks.

The TALKSAFE is a safe, hygienic and flexible solution which is particularly suitable for acrylic walls and acrylic cubicles at pharmacies, doctors' surgeries, shops and supermarkets as well as for visitor boxes in retirement homes. Thus, facilitating consultation and communication.

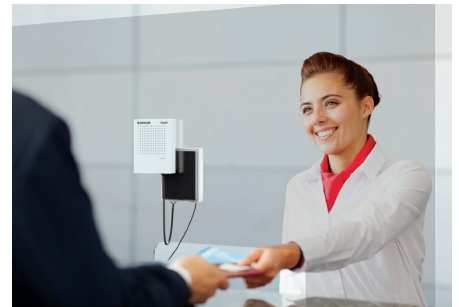

TALKSAFE

Order No. 1000189

TALKSAFE is a kit which consists of:

- 1 x microphone station for customers
- 1 x microphone station for staff
- 1 x power supply
- Including required cables
- Including double-sided adhesive tape

The TALKSAFE can very easily be integrated into your environment and workflows:

- Non-contact: infrared sensors detect if a person is standing in front of the device
- Retrofitting: no integration into existing systems or networks required

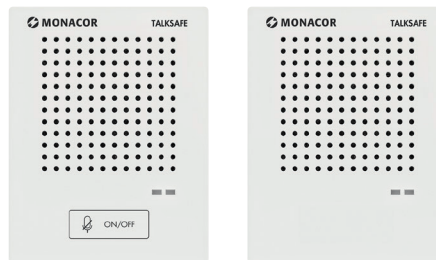

- Hygiene: device can easily be cleaned with a surface cleaner
- POS: ideally suited for highly frequented areas
- No extensive staff training required

Model	TALKSAFE
Description	intercom system
Nominal value	activation/deactivation via infrared
Type	microphones: AEC technology (Acoustic Echo Cancellation/echo compensation) and NR technology (Noise Reduction/suppression of ambient noise)
Colour	white
Material	ABS plastic
Suitable for	hygiene walls
Power supply	via encl. power supply
Admiss. ambient temp.	-10 °C to +40 °C
Dimensions	86 x 111 x 26 mm (microphone station)
Length	connection cable: 1 m mains cable: 2 m
Weight	160 g per microphone station

TALKSAFE-1

Order No. 1000190



The TALKSAFE-1 kit consists of:

- 1 x microphone station for customers
- 1 x on-ear headset for staff (Bluetooth)
- 1 x power supply
- Incl. required cables
- Incl. double-sided adhesive tape

The TALKSAFE-1 can very easily be integrated into your environment and workflows:

- Non-contact: infrared sensors detect if a person is standing in front of the device
- Retrofitting: no integration into existing systems or networks required
- Hygiene: device can easily be cleaned with a surface cleaner



- POS: ideally suited for highly frequented areas
- No extensive staff training required

Model	TALKSAFE-1
Description	intercom system
Nominal value	activation/deactivation via infrared
Type	microphones: AEC technology (Acoustic Echo Cancellation/echo compensation) and NR technology (Noise Reduction/suppression of ambient noise)
Colour	white
Material	ABS plastic
Suitable for	hygiene walls
Power supply	via encl. power supply
Admiss. ambient temp.	-10 °C to +40 °C
Dimensions	86 x 111 x 26 mm (microphone station)
Weight	160 g per microphone station

TALKSAFE-HS

Order No. 1000228

Bluetooth headset

- Additional on-ear headset, comfortable to wear, for Bluetooth intercom system TALKSAFE-1
- Headset microphone
- Operating range: 5-10 m
- Supplied with USB charging cable
- Rech. battery operating time in continuous operation: approx. 11 h



Model	TALKSAFE-HS
Description	Bluetooth headset
Suitable for	TALKSAFE-1
Power supply	via built-in rech. batt.
Admiss. ambient temp.	-10 °C to +40 °C
Weight	60 g

DH-95N

Order No. 0230030

DH-95NP

Order No. 0234100

Dynamic hand-held microphones

- Low impedance
- With push-to-talk button
- Particularly suitable for CB and PA
- Supplied with microphone holder
- 300-6,000 Hz, 2.5 mV/Pa/1 kHz, 500 Ω

DH-95N: helix connection cable with open cable ends

DH-95NP: helix connection cable with 6.3 mm stereo plug



Speaker Cables

"TOP QUALITY, HIGHLY FLEXIBLE"

- 100 m reel
- Suitable for stage applications as well as for 100 V line technique
- Metre marking

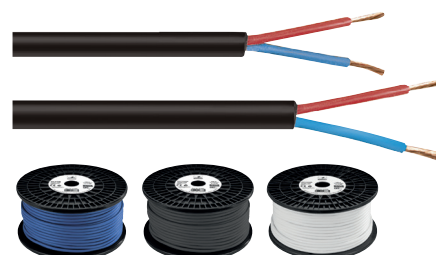

Model	Order No.	Colour	Internal conductor	Cable diameter
SPC-515/BL	0129680	blue	2 x 1.5 mm ²	Ø 7.4 mm
SPC-515/SW	0129690	black	2 x 1.5 mm ²	Ø 7.4 mm
SPC-515/WS	0129700	white	2 x 1.5 mm ²	Ø 7.4 mm
SPC-525/SW	0129710	black	2 x 2.5 mm ²	Ø 8.2 mm

CAT-7100A

Order No. 0068900

100m

Cat. 7_A installation cable, multiple shielding, S/FTP

- 100 m, shrink-wrapped coil
- 10 Gbps, 1,000 MHz
- Conductor pairs in metal foil (PiMF), complies with EIA/TIA 568
- Overall braided shield
- Cable specification: 4x2xAWG 23
- Outside diameter: Ø 7.50 mm

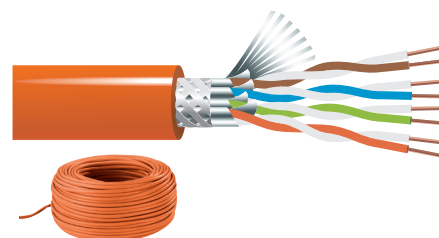

Signal Line

For alarm, PA and communication technology.

- 100 m coil
- Type J-Y(St)Y acc. to VDE 0815
- Copper index: 21 kg/km
- Common foil shield
- Copper wires with coloured insulation

100m

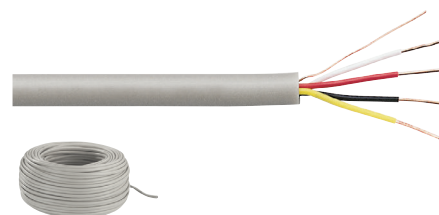

Model	Order No.	Length	Colour	Internal conductor	Cable diameter
JYSTY-2208	0111340	100 m	grey	4 x Ø 0.8 mm, 0.5 mm ²	Ø 7 mm
JYSTY-2206	0192310	100 m	grey	4 x Ø 0.6 mm, 0.28 mm ²	Ø 5.5 mm

CST-2

Order No. 0311500

Stripping tool for coaxial cables

- For gradually stripping of all standard coaxial cables, also suitable for flexible cables, e.g. 3 x 0.75 mm², 10 mm² and 16 mm²
- Easy handling due to ergonomic design
- Adjusting the cutting depth is not required



CST-5

Order No. 0311520

Stripping tool, self-adjusting,

- Particular large working range: 0.2-6.0 mm²
- Stripping length: 8-12 mm
- Glass fibre reinforced polyamide
- Stripping tool and side cutter (up to: Ø 2 mm) made of hardened special steel



CAT-1TOOL

Order No. 0310060

Network punch down tool

- For LSA connection technology (without soldering, screwing and stripping)
- Metal insertion blade
- Draw-hook and blade release, folding
- Belt clip



CAT-1TEST

Order No. 0292070

Line tester, for testing the continuity of Cat. 5, Cat. 6 and ISDN network lines.

- Detection of continuity, miswiring, disconnection, short circuit, crossover cable and earthing
- Power supply via 9 V battery (not supplied)
- Supplied with protective bag



CC-132

Order No. 0348670

CC-133

Order No. 0347180

Connecting terminals from WAGO

- Terminal with operating levers
- For flexible conductors: 0.08-4 mm²
- For rigid conductors: up to 2.5 mm²
- Power rating 2.5 mm²: 400 V/24 A, 4 mm²: 400 V/32 A



CC-132: 2-conductor terminal
CC-133: 3-conductor terminal

CC-142

Order No. 0342270

CC-143

Order No. 0342360

CC-145

Order No. 0342460

Connecting terminals from WAGO

- Terminal with operating levers
- Individually combinable wires and cross sections from 0.14 to 4 mm²
- Power rating: 450 V/32 A
- Two test slots for any standard test prod



CC-142: 2-conductor terminal
CC-143: 3-conductor terminal
CC-145: 5-conductor terminal

RWM-2D

Order No. 0256080

RWM-1D

Order No. 0256070

Rack-mount cable ducts, for horizontal cable routing in 482 mm (19") racks, e.g. RACK-33NV.

- Metal rack panels, black powder-coated
- Black plastic cable duct

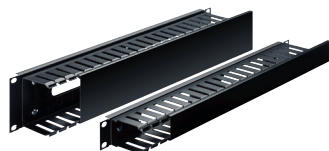

RWM-1D: 1 RU, 482 x 44 x 70 mm

RWM-2D: 2 RU, 482 x 88 x 70 mm

RWM-2H

Order No. 0256090

Rack-mount patch cable management panel, for 482 mm (19") racks.

- Metal rack panel, black powder-coated
- 5 black plastic brackets
- 482 x 88 x 90 mm, 2 RU



RACK-42NV

Order No. 0257650



RACK-33NV

Order No. 0257640



RACK-21NV

Order No. 0257630



RACK-15NV

Order No. 0257620



Equipment racks for 482 mm (19") devices

- Sheet steel version
- Light grey powder coating (RAL 7035)
- Front door with safety glass and swivel handle lock
- Hinges can easily be changed for door to be opened to the left or to the right
- Side walls and rear wall can be removed and locked
- Supplied with earthing set, 4 levelling feet and 28 mounting kits

RACK-42NV: 42 RU

RACK-33NV: 33 RU

RACK-21NV: 21 RU

RACK-15NV: 15 RU

Image similar.



Model	RACK-42NV	RACK-33NV	RACK-21NV	RACK-15NV
Size	482 mm (19")	482 mm (19")	482 mm (19")	482 mm (19")
Rack units, RU	42	33	21	15
Colour	light grey (RAL 7035)	light grey (RAL 7035)	light grey (RAL 7035)	light grey (RAL 7035)
Mounting accessories	earthing set, 28 mounting kits	earthing set, 28 mounting kits	earthing set, 28 mounting kits	earthing set, 28 mounting kits
Usable depth	590 mm	590 mm	590 mm	590 mm
Outside dimensions	600 x 1,978 x 600 mm	600 x 1,578 x 600 mm	600 x 1,045 x 600 mm	600 x 778 x 600 mm
Max. load capacity	500 kg	300 kg	300 kg	300 kg
Weight	73 kg	55 kg	42 kg	38 kg

RACK-12W

Order No. 0244520



RACK-6W

Order No. 0244540



Wall-mounted housings for 482 mm (19") devices

- Sheet steel version
- Light grey powder coating (RAL 7035)
- Lockable front door with safety glass
- Door can be opened either to the left or to the right
- Side walls and rear wall can be removed and locked
- Maximum mounting depth behind the front plate: 370 mm
- Supplied with earthing set and 16 sets of mounting screws

RACK-12W: 12 RS

RACK-6W: 6 RS

Model	RACK-12W	RACK-6W
Size	482 mm (19")	482 mm (19")
Rack units, RU	12	6
Colour	grey (RAL 7035)	grey (RAL 7035)
Mounting accessories	earthing set, 16 sets of mounting screws	earthing set and 16 sets of mounting screws
Usable depth	380 mm	380 mm
Outside dimensions	600 x 624 x 400 mm	600 x 358 x 400 mm
Max. load capacity	40 kg	40 kg
Weight	24 kg	15 kg

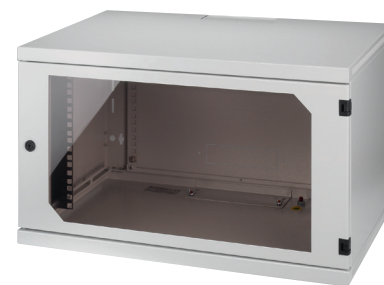

RACK-12WP

Order No. 0244530



RACK-6WP

Order No. 0244550



Wall-mounted housings for 482 mm (19") devices, with movable middle part of the housing.

- Sheet steel version
- Light grey powder coating (RAL 7035)
- Lockable front door with safety glass
- Door can be opened either to the left or to the right
- Side walls and rear wall can be removed and locked
- Max. mounting depth behind the front plate: 470 mm
- Supplied with earthing set and 16 sets of mounting screws

RACK-12WP: 12 RS

RACK-6WP: 6 RS

Model	RACK-12WP	RACK-6WP
Size	482 mm (19")	-
Rack units, RU	12	6
Colour	grey (RAL 7035)	grey (RAL 7035)
Mounting accessories	earthing set, 16 sets of mounting screws	earthing set, 16 sets of mounting screws
Usable depth	490 mm	490 mm
Outside dimensions	600 x 624 x 500 mm	600 x 358 x 500 mm
Max. load capacity	40 kg	40 kg
Weight	26 kg	19 kg

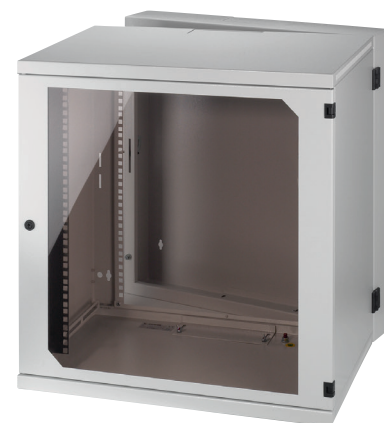



CD-156

Order No. 0212410



Stereo CD and MP3 player, with USB 2.0 interface, for hi-fi and PA applications.

- USB storage media can be connected directly (e.g. USB hard disk, USB flash drive)
- Anti-shock system
- Repeat function (repeat 1, repeat all), random play, standard operating functions
- Adjustable headphone output
- Supplied with infrared remote control with direct track selection
- 482 mm (19") rack installation with supplied mounting brackets, 2 RU
- Audio CD/CD-R/MP3 CD

Model	CD-156
Frequency range	20-20,000 Hz
THD	< 0.1%
Channel separation	> 80 dB
Dynamic range	> 90 dB
S/N ratio	> 80 dB
Output, analogue	2 V
Power supply	~ 230 V/50 Hz/25 VA
Dimensions	420 x 90 x 285 mm, 2 RU (w/o mounting brackets)
Weight	3.66 kg
Connections	1 x RCA L/R, 1 x 6.3 mm jack (headphones)
Packing dimensions (W x H x L)	0.34 x 0.14 x 0.47 m
Gross weight	4.34 kg



DMP-130MIXBT

Order No. 1000062



MP3 player and microphone line mixer

With this unit combination, it is possible to mix 3 audio signal sources. The integrated MP3 player can be switched between SD card, USB port and Bluetooth receiver.

- For USB and SD storage media
- Alphanumeric display
- Repeat function
- Preprogrammed sound adjustments
- 3 input channels with level control (mic, aux/MP3, line)
- Aux input and microphone input via front panel connection
- 2-way tone control and level control for the master output
- Infrared remote control for MP3 player
- Blue backlit LCD
- 482 mm (19") rack installation

Model	DMP-130MIXBT
Media	MP3, USB, SD, MMC
Frequency range	20-20,000 Hz
THD	< 0.1%
Channel separation	> 60 dB
Dynamic range	> 96 dB
S/N ratio	> 70 dB
Output, analogue	2 V (XLR, bal.) 1 V (RCA)
Power supply	~ 230 V/50 Hz/20 VA
Dimensions	482 x 44 x 165 mm, 1 RU
Weight	2.36 kg
Connections	1 x combo 6.3 mm/XLR (mic/line), 1 x 3.5 mm jack (aux in), 1 x RCA L/R (line in), 1 x RCA L/R (line out), 1 x XLR L/R, bal. (output)
Packing dimensions (W x H x L)	0.55 x 0.12 x 0.2 m
Gross weight	2.74 kg

CD-112/BT

Order No. 0212940



CD and MP3 player, with Bluetooth receiver, USB interface and SD/MMC card slot.

- Bluetooth receiver for wireless connection of laptops, smartphones or tablet PCs
- USB storage media can be connected directly
- For SD/MMC cards up to 32 GB (FAT16/FAT32), available at option
- Anti-shock system
- Supports ID3 tags
- Folder navigation
- Autoplay function
- Fast forward and reverse
- Track programming
- Repeat function (repeat 1, repeat all, random repeat)
- Random play
- Supplied with infrared remote control



- 482 mm (19") rack installation with supplied mounting brackets, 1 RU
- Audio CD/CD-R/CD-RW/MP3 CD

Model	CD-112/BT
Media	CD, MP3, USB, SD, MMC
Frequency range	20-20,000 Hz
THD	< 0.1%
Channel separation	> 60 dB
Dynamic range	> 96 dB
S/N ratio	> 70 dB
Output, analogue	1.2 V
Power supply	~ 230 V/50 Hz/50 VA
Dimensions	482 x 44 x 265 mm, 1 RU
Weight	3.97 kg
Connections	1 x RCA L/R (CD) 1 x RCA L/R (Bluetooth) 1 x RCA L/R (priority)
Packing dimensions (W x H x L)	0.37 x 0.12 x 0.54 m
Gross weight	4.65 kg

CD-112RDS/BT

Order No. 0212950



CD and MP3 player with FM RDS tuner and Bluetooth receiver.

- Bluetooth receiver for wireless connection of laptops, smartphones or tablet PCs
- FM RDS tuner with 30 station presets
- USB storage media can be connected directly
- For SDHC cards up to 32 GB (FAT16/FAT32), available at option
- Anti-shock system
- Supports ID3 tags
- Folder navigation
- Autoplay function
- Fast forward and reverse
- Track programming
- Repeat function (repeat 1, repeat all, repeat folder)
- Random play
- RS-232 interface for remote control



- Supplied with infrared remote control and antenna
- 482 mm (19") rack installation with supplied mounting brackets, 1 RU
- Audio CD/CD-R/CD-RW/MP3 CD

Model	CD-112RDS/BT
Media	CD, MP3, FM, USB, SD, MMC
Frequency range	20-20,000 Hz
THD	< 0.1%
Channel separation	> 60 dB
Dynamic range	> 96 dB
S/N ratio	> 70 dB
Output, analogue	1.2 V
Power supply	~ 230 V/50 Hz/50 VA
Dimensions	482 x 44 x 265 mm, 1 RU
Weight	4.1 kg
Connections	1 x XLR L/R, bal. (CD) 1 x XLR L/R, bal. (priority) 1 x RCA L/R (Bluetooth) 1 x RCA L/R (tuner)
Packing dimensions (W x H x L)	0.37 x 0.115 x 0.535 m
Gross weight	4.83 kg

DR-463

Order No. 0210230



WLAN Internet radio adapter, with DLNA, DAB+, FM and Bluetooth.

- Internet/DAB+/FM radio/Bluetooth
- DLNA home networking can be activated with suitable app
- Radio operation via smartphone
- Playing music from your smartphone
- Bluetooth for using streaming services like Spotify, Apple Music, Google Play Music, etc. via your smartphone
- Large colour display
- 250 Internet radio stations can be stored
- Clock radio with 2 alarm clock settings, timer, sleep timer
- Weather forecast for 5,000 cities worldwide, 500 of which are in Germany
- Power saving mode/dimmer

- Menu navigation in 17 languages
- Line out jack
- WLAN
- Streaming media via UPnP and DLNA
- Smart Home Ready
- Connection for external antenna (IEC)
- Scope of delivery: remote control (incl. batteries), RCA cable, power supply, wire antenna, antenna adapter



Model	DR-463
Media	UPnP, DLNA, DAB+, Bluetooth
Frequency range	20-20,000 Hz
Power supply	~ 230 V
Admiss. ambient temp.	0-40 °C
Dimensions	190 x 75 x 35 mm
Weight	256 g
Connections	line out, antenna
Packing dimensions (W x H x L)	0.075 x 0.04 x 0.19 m
Gross weight	0.79 kg

Audio Players Tuners

WAP-202RS

Order No. 1000259



Internet radio, FM RDS and DAB+ tuner, MP3 player

- Bluetooth interface
- Network connection via LAN jack or WLAN
- Access to more than 20,000 radio stations worldwide
- Station scan by genre, station name, location
- Streaming media from files shared within the network (UPnP server) and streaming medium
- FM RDS reception function
- Reception of interference-free 'digital radio' (DAB+)
- USB host input for directly playing MP3, AAC, AAC+, WMA, WAVE and FLAC files
- Multi-room function
- Easy operation via jog dial
- Large illuminated matrix display
- Equalizer with factory presets and user presets
- Shuffle play and repeat folder via USB
- Summer time/winter time selection
- Sleep timer and alarm clock function with snooze
- Can be remote-controlled via infrared remote control, RS-232 interface or app
- Aux input on the front panel (3.5 mm stereo jack)
- Headphone output (3.5 mm stereo jack)
- 75 Ω FM antenna input, coaxial
- RP-SMA antenna connection
- RS-232 interface

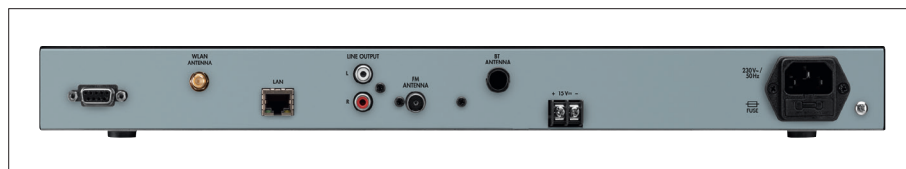

- Supplied with infrared remote control, rod antennas and FM wire antenna
- 482 mm (19") rack installation, 1 RU, removable mounting brackets

Model	WAP-202RS
Media	Bluetooth, FM, DAB+, MP3, LAN/WLAN, streaming medium
Output, analogue	750 mV
Power supply	~ 230 V/50 Hz/20 VA = 15 V/300 mA
Dimensions	482 x 44 x 245 mm
Weight	2.7 kg
Connections	1 x 3.5 mm stereo jack (aux in), 1 x RCA L/R (line out), 1 x 3.5 mm stereo jack (headphones), 1 x RJ45 (LAN) 1 x Bluetooth antenna 1 x WLAN antenna 1 x RS-232 interface

FM-102DAB

Order No. 0174490



Digital stereo tuner for reception of FM and DAB+

- FM radio reception (87.5-108 MHz) with RDS function
- Reception of interference-free digital radio via digital audio broadcasting (DAB+, band III, 174.928-239.2 MHz)
- Display of additional broadcasting information, e.g. frequency, name of radio station, genre, track name, artist
- Large backlit dot matrix display
- Field intensity display
- 20 station presets each for FM mode and DAB mode
- 10 station keys with double assignment
- Manual frequency adjustment and station adjustment
- Automatic station scanning
- Mono/stereo selection
- Sleep mode
- 75 Ω antenna input
- Supplied with infrared remote control and telescopic antenna
- 482 mm (19") rack installation, 1 RU, removable mounting brackets

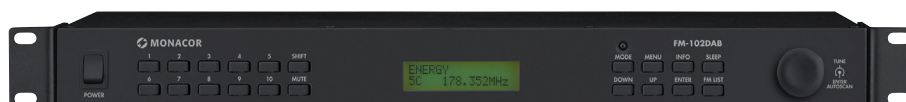

Model	FM-102DAB
Media	FM, DAB+
Power supply	~ 230 V/50 Hz/50 VA
Dimensions	482 x 44 x 185 mm
Weight	2.66 kg
Connections	1 x RCA L/R
Packing dimensions (W x H x L)	0.305 x 0.11 x 0.545 m
Gross weight	3.23 kg

M-32CD

Order No. 0173350



CD player module, with anti-shock system and MP3 reproduction.

- Slot-in mechanism
- USB port for external storage media
- SD/MMC card slot for SD cards up to 32 GB, available at option
- Random play, repeat function
- Single play function
- Track programming
- Connection for foot switch for remote control play/pause function
- Supplied with remote control
- Mounting cutout: 155 x 50 x 150 mm
- Audio CD/CD-R/CD-RW/MP3 CD
- RCA connection cable DMP-12CC is available at option



Model	M-32CD
Media	CD, MP3, USB, SD (MMC, SD, SDHC)
Frequency range	20-20,000 Hz
THD	< 0.1%
Channel separation	> 60 dB
S/N ratio	> 70 dB
Output, analogue	1.2 V
Power supply	= 12 V/800 mA
Dimensions	174 x 52 x 160 mm
Weight	1.145 kg
Packing dimensions (W x H x L)	0.215 x 0.22 x 0.11 m
Gross weight	1.31 kg

DMP-102

Order No. 0177090



Compact MP3 player insertion module, with USB interface and SD/MMC card slot.

- USB storage media can be connected directly
- For SD/MMC cards (FAT16/FAT32), available at option
- Autostart function
- Fast forward and reverse
- Repeat function (repeat 1, repeat all)
- Green backlit LCD
- Supplied with infrared remote control
- RCA cable DMP-12CC is available at option



Model	DMP-102
Media	MP3, USB, SD, MMC
Frequency range	20-20,000 Hz
THD	< 0.2%
Channel separation	> 60 dB
S/N ratio	> 75 dB
Output, analogue	500 mV
Power supply	= 12 V/150 mA
Dimensions	120 x 22 x 58 mm
Weight	39 g
Packing dimensions (W x H x L)	0.075 x 0.065 x 0.17 m
Gross weight	0.165 kg



RETAIL Catalogue

Come and have a look at www.monacor.com and order your very own copy of the RETAIL catalogue.

MONACOR
INTERNATIONAL
THE AUDIO COMPANY

The versatile audio matrix system DRM-884 ...

A general solution for versatile multi-room PA concepts with fixed installations in hotels, restaurants and bars, conference rooms, schools, sports and fitness centres.

The matrix system DRM-884 is a professional tool with extensive features which easily meets any requirement: users can combine signal sources, play one source in several zones or several sources in one zone, adjust the volume in each zone and much more. The audio matrix router DRM-884 is the heart of the system which is able to distribute a maximum of 8 analogue and 4 digital audio sources to just as many output zones, any assignment possible. You can either connect active speakers or a power amplifier with passive speakers to the output zones via Phoenix terminals.

The multifunctional matrix system is controlled via wall panels: modules DRM-884VAP and DRM-884VP allow you to remotely access, e.g. level and program selection in the different zones. The wall panel DRM-884IOP allows for other connection options are available, e.g. at the location of the PA application. The zone paging microphone DRM-884RC with zone selection can be connected for announcements.

Expand your options with the matrix system: if you need a larger number of inputs and outputs, the system can be extended from a maximum of 16 x DRM-884 and optional Dante® module to 192 inputs x 192 outputs by means of cascading.

With the Dante® extension module DRM-884DTM, the DRM-884 can quickly and easily be inserted into a Dante® audio network. For this purpose, there are an additional 8 digital inputs or 8 digital outputs available which can be assigned to either an analogue output or a Dante® channel.



DRM-884

Order No. 0176940



Audio matrix router

- 8 analogue inputs and 8 analogue outputs
- 4 digital inputs and 4 digital outputs for the extensions DRM-884RC, DRM-884IOP and DRM-VAP
- An additional 8 digital inputs and 8 digital outputs via Dante® module DRM-884DTM, available at option
- DSP for inputs and outputs, control via software
- Integrated auto mixer, feedback controller and ducker
- Predefined types of filters 6-48 dB/oct. (Butterworth, Bessel, Linkwitz-Riley)
- Up to 2 zone paging microphones DRM-884RC can be connected
- Wall modules DRM-884IOP, DRM-884VAP and DRM-884VP can be connected as remote control
- Link function for several audio matrix routers DRM-884
- Can be remote-controlled via RS-232 interface or app (Android)
- LCD for showing device information
- LED status indication
- LED indication for clip and signal per input and output
- 482 mm (19") rack installation

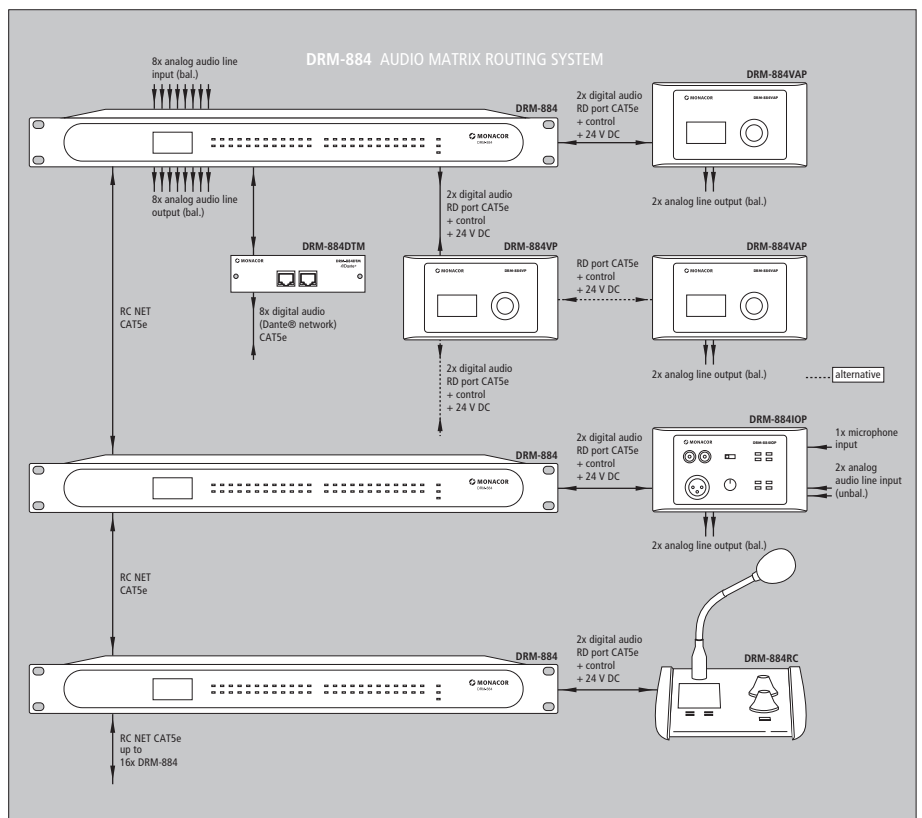
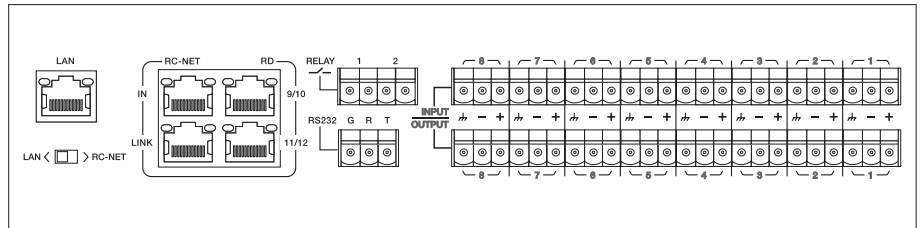

Model	DRM-884
Frequency range	20-20,000 Hz
Input impedance	5 kΩ
Output impedance	240 Ω
Phantom power	48 V
Channel separation	> 87 dBA
THD	< 0.01%
Power supply	~ 230 V/50 Hz/80 VA
Dimensions	482 x 44 x 270 mm, 1 RU
Weight	4.22 kg
Inputs	screw terminals
Outputs	screw terminals
Other features	5 x RJ45

DRM-884RC

Order No. 0176990

PA zone paging microphone, for audio matrix router DRM-884.

- LCD for selected zones (1-32), volume and ID number
- LED indication for signal status
- Volume control (assignable for each zone)
- Zone selector control
- Momentary push-to-talk button
- Plug-in electret gooseneck microphone (NEUTRIK 3-pole XLR jack)

- USB port for loading sound files containing chimes
- Power supply via audio matrix router DRM-884
- Connection to DRM-884 via RJ45 jack and Cat. 5e network cable (supplied w/o cable), cable length up to 100 m



DRM-884IOP

Order No. 0176960

Wall module, for remote control of audio matrix router DRM-884.

- Intended application: remote control of one zone, local insertion of audio signals
- 2 RCA jacks for line signals
- Adjustable microphone connection via NEUTRIK 3-pole XLR jack
- 48 V phantom power, to be activated as required
- LED indication for input signals and output signals

- Connection to DRM-884 and power supply via RJ45 jack and Cat. 5 network cable, cable length up to 100 m



DRM-884VAP

Order No. 0176970

Wall module, for remote control of audio matrix router DRM-884.

- Intended application: volume control with audio output
- LCD
- Volume control
- Connection to DRM-884 via RJ45 jack and Cat. 5e network cable (supplied w/o cable), cable length up to 100 m



DRM-884VP

Order No. 0176980

Wall module, for volume control of audio matrix router DRM-884.

- Intended application: volume control
- LCD
- Volume control
- Connection to DRM-884 via RJ45 jack and Cat. 5e network cable (supplied w/o cable), cable length up to 100 m



DRM-884DTM

Order No. 0176950

Dante® module, for inserting audio matrix router DRM-884 into a Dante® network.

- Audio transmission via Ethernet using Dante® protocol
- 8 digital inputs and 8 digital outputs
- Easy signal control via network technology
- Mini PCI plug-in board
- Connections: 2 x RJ45

The brand Dante® as well as the Dante® software which may have been integrated into these products are licenced by Audinate Pty Ltd.

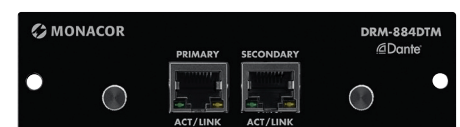

System requirements: Windows 7/8/10 or MacOS X



DRM-882LAN

Order No. 0179250



Digital 8x8 matrix router

- 8 inputs and 8 outputs (plug-in screw terminals, switchable mic/line, balanced)
- +48 V phantom power
- User-defined routing of the inputs to the outputs
- The level of each routed input can be adjusted per assigned output (individual output mix)
- Up to 32 devices can be managed via software
- A/D converter: 4 x 24 bits, D/A converter: 1 x 24 bits
- Extensive signal processing and monitoring, e.g. frequency shift feedback eliminator, parametric 5-band equalizer with peak and shelving filters, variable low-pass/high-pass filters - optionally with Bessel, Butterworth or Linkwitz-Riley characteristics, RMS compressor, peak limiter, selectable phase, delay
- Integrated auto mixer
- 6-fold LED status cluster for each channel
- 6 user presets can be accessed directly
- Link feature for simultaneously changing the settings of several channels
- Stereo mode for the channels 1/2, 3/4, 5/6 and 7/8
- Dot matrix display with 2 x 24 characters
- Remote control via USB, RS-485 or TCP/IP LAN
- Real-time remote control via software
- Lock mode for front panel control
- Individual room control via optional wall-mounted remote control panel DRM-882WP or DRM-882WPX
- Robust steel housing with aluminium front panel
- 482 mm (19") rack installation, 1 RU

Input (data for each channel):

- Gain control with 0 dB bypass function
- Noise gate
- Mic/line switching
- Selectable priority circuit
- Parametric 3-band equalizer (peak, low-pass shelving, high-pass shelving)
- Frequency shift feedback eliminator
- Selectable phase (180°)

Output (data per channel):

- Low-pass filter/high-pass filter with Butterworth, Linkwitz-Riley and Bessel characteristics (to -24 dB/oct.). Even higher slopes possible in combination with equalizer
- Parametric 5-band equalizer with peak or low-pass/high-pass shelving filters
- Peak limiter and RMS compressor with a ratio of up to 32:1 and continuously adjustable soft/hard knee characteristics. Threshold: 18 dBu to -12 dBu, release time: 0.1-3 s, attack time: 5-200 ms
- Peak limiter and RMS compressor with bypass function
- Switchable delay between time (ms) and distance (m): 380.998 ms max. in steps of 21 µsec or 129.539 m max. in steps of 6.8 mm
- Selectable phase (180°)
- Gain control

Model	DRM-882LAN
Frequency range	20-20,000 Hz
Input signal	6.2 V max.
Output signal	6.2 V max.
Crossover frequency	70 Hz-1 kHz, 12 dB/oct., 910 Hz-8 kHz, 12 dB/oct., subwoofer: 80/120 Hz, 24 dB/oct.
S/N ratio	> 104 dB
THD	< 0.005%
Power supply	~ 230 V/50 Hz/20 VA
Dimensions	482 x 44 x 250 mm, 1 RU
Weight	3.4 kg

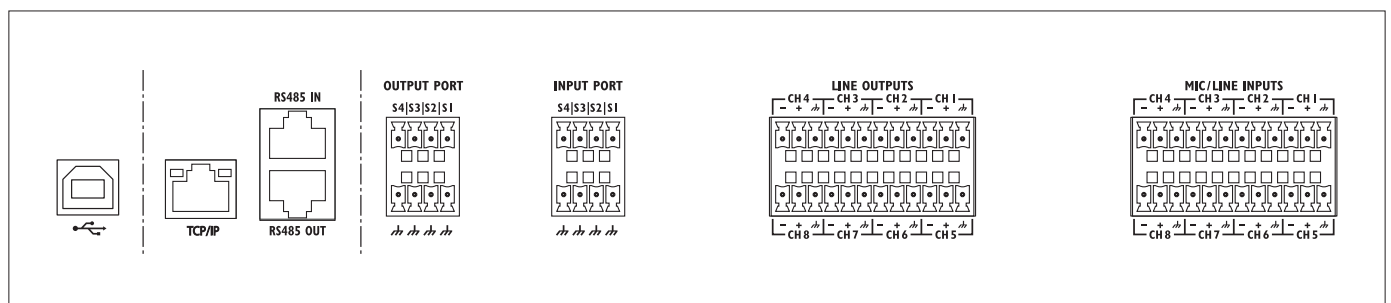

DRM-882WP

Order No. 0170014

Wall-mounted remote control panel, for digital matrix router DRM-882LAN.

- The first 4 presets of the DRM-882LAN can be activated at the touch of a button
- Preset status display
- Individual adjustment of the master volume
- Protected from unauthorised access via key switch
- Connection to DRM-882LAN via RS485 interface
- Power supply: $\approx 5\text{ V}/20\text{ mA}$ via power supply PSS-510DC, available at option



DRM-882WPX

Order No. 0170015

Wall-mounted remote control panel, for digital matrix router DRM-882LAN.

- 3 operating modes: system setup, master and zone
- Push-buttons to select the 6 presets of the DRM-882LAN
- Volume control for each zone
- Gain control
- Source selection for each zone
- Auto standby (selectable)
- Lock mode
- LCD with 2 x 20 characters

- Connection to DRM-882LAN via RS485 interface
- Power supply: $\approx 12\text{ V}/75\text{ mA}$ via power supply PSS-1205DC, available at option
- Supplied with flush-mounted housing

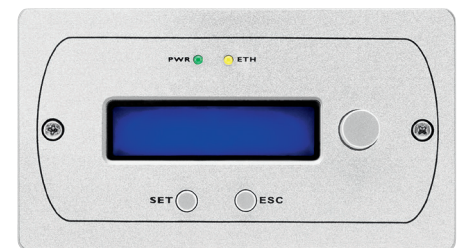

MCA-100J/XP

Order No. 1000617



Adapter cable, for easily connecting an XLR audio signal, e.g. to screw terminals or spring-loaded terminals.

- 1 x 3-pole XLR inline jack, 1 x open cable ends
- Length: 1 m, 2 cores, shielded, balanced



MCA-100P/XP

Order No. 1000618



Adapter cable, for easily connecting an XLR audio signal, e.g. to screw terminals or spring-loaded terminals.

- 1 x 3-pole XLR plug, 1 x open cable ends
- Length: 1 m, 2 cores, shielded, balanced



Audio Matrix System

The system ARM-880... from MONACOR is a highly flexible PA solution for multi-room applications. It is ideally suited for applications in hotels, in restaurants and bars, in conference rooms, schools, sports facilities and fitness centres. Eight different audio sources, e.g. CD players, SAT receivers, radio programmes can be distributed to 8 output zones, assignment as required.

The audio matrix router ARM-880 is the centrepiece of the system. For operation, one amplifier is required for each output used. This may be an individual power amplifier or an active speaker system. Matching wall modules ARM-880WP1, ARM-880WP2

and ARM-880WP3 for remote control of ARM-880 or with additional local inputs for the respective zone are available at option.

With a master/slave connection, it is possible to extend the system to up to 32 output zones. Connections for various alarm signals and a local microphone are available.

Announcements can be made via 2 optional zone paging microphones ARM-880RC with zone selection.



ARM-880

Order No. 0173800



Audio matrix router

- 8 audio inputs and 8 audio outputs
- Inputs 1-4, line, with gain control
- Inputs 5-8, switchable line/mic
- 2 zone paging microphones ARM-880RC and 1 local microphone (for all zones) can be connected
- 1 additional audio input for each zone, non-routable, with gain control
- 8 wall modules ARM-880WP... can be connected as remote control
- Extendable to up to 32 zones
- Microphone, music and master volume controls for each zone
- 2-way tone control for each zone
- Priority management
- Emergency announcement with priority for each zone, even when extended

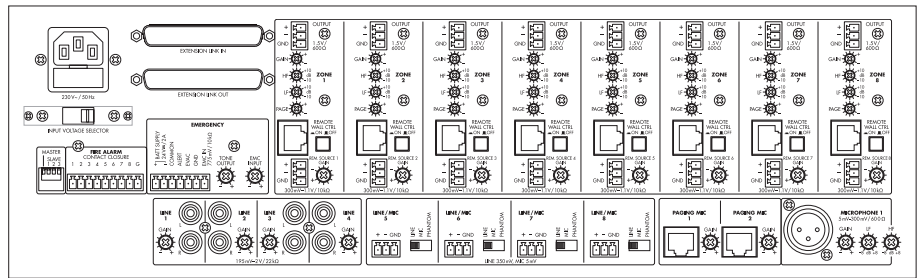

- 3 different alarm signals
- 7-segment LED display for each zone
- Clipping indicator
- Monitoring function with built-in speaker
- 482 mm (19") rack installation
- Mains operation or 24 V emergency power operation

Model	ARM-880
General Information	
Frequency range	20-20,000 Hz (line) 80-18,000 Hz (mic)
Input sensitivity	
Mic 1	300 mV/660 Ω
Zone paging microphone	500 mV/10 kΩ
line 1-4	195 mV-2 V/47 kΩ
line 5-8	350 mV (line) 5 mV (mic)
zone 1-8	300 mV-1.1 V/10 kΩ
Emergency announcement	775 mV/10 kΩ
Outputs	
zone 1-8	1.5 V/600 Ω
Equalizer bass	± 10 dB/100 Hz
Equalizer treble	± 10 dB/10 kHz
S/N ratio	> 65 dB (mic) > 85 dB (line)
THD	< 0.07%
Admiss. ambient temp.	0-40 °C
Power supply	~ 230 V/50 Hz/30 VA
Dimensions	484 x 138 x 325 mm, 3 RU
Weight	10.73 kg
Connections	
Mic 1	1 x XLR
Zone paging microphone	2 x RJ45
Line 1-4	4 x RCA L/R
Line/Mic 5-8	4 x plug-in screw terminal
Zone 1-8	8 x plug-in screw terminal (IN) 8 x plug-in screw terminal (OUT)
Wall modules	8 x RJ45
Fire alarm	9-pole plug-in screw terminal
Emergency announcement	1 x plug-in screw terminal
24 V _{DC}	1 x plug-in screw terminal
Alarm	1 x plug-in screw terminal
EVAC	1 x plug-in screw terminal
Extension	2 x D-sub DC37 (IN/OUT)

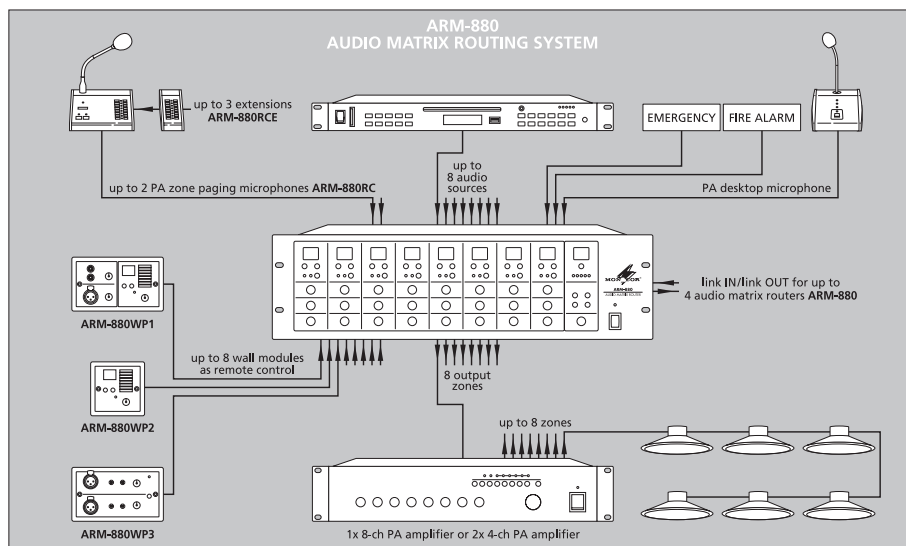

ARM-880RC

Order No. 0173810

PA zone paging microphone, for audio matrix router ARM-880.

- 8 zones
- Zones can individually be controlled, group call
- Replaceable label for marking the zones
- Plug-in electret gooseneck microphone (3-pole XLR)
- 2-tone or 4-tone chime, can be switched off
- Volume control for microphone and chime
- LEDs for indicating operation, output level and selected zone
- 8 additional zones with each extension module (available at option), 32 zones in total with a maximum of 3 extension modules, connection via existing ribbon cable
- Connection to ARM-880 via RJ45 jack and Cat. 5 network cable (supplied w/o cable)
- Power is provided via enclosed power supply



ARM-880RCE

Order No. 0173820

8-zone extension module, for PA zone paging microphone ARM-880RC.

- 8 zones can individually be controlled
- Replaceable label for marking the zones
- LED indication for selected zone
- Addressing via DIP switches
- Connection to ARM-880RC or additional ARM-880RCE via ribbon cable
- Power supply via ARM-880RC



ARM-880WP1

Order No. 0173830

Wall module, for remote control of audio matrix router ARM-880.

- Intended application: remote control of one zone, local insertion of audio signals
- 2 RCA jacks for line signals
- Microphone connection via NEUTRIK 3-pole XLR jack
- Source selector switch
- Level controls for line, microphone and source
- 15 V phantom power
- 7-segment LED display
- Connection to ARM-880 and power supply via RJ45 jack and Cat. 5 network cable. A separate power supply is required for operation with cable lengths of more than 50 m
- Dimensions front panel: 146 x 86 mm
- Supplied with robust flush-mounted metal housing



ARM-880WP2

Order No. 0173840

Wall module, for remote control of audio matrix router ARM-880.

- Intended application: remote control of 1 zone
- Source selector switch
- Level control
- 7-segment LED display
- Connection to ARM-880 and power supply via RJ45 jack and Cat. 5 network cable. A separate power supply is required for operation with cable lengths of more than 50 m
- Dimensions front panel: 86 x 86 mm
- Supplied with robust flush-mounted metal housing



Signal Processing Mixers

PA-6040MPX

Order No. 0174760



4-zone mixer, for general multi-room PA applications.

- 4 zones with user-defined routing of all input channels
- 4 inputs microphone/line via comb. jacks
- 2 inputs line stereo via RCA jacks
- Each input channel with gain control, 2-way tone control and zone routing switch
- Microphone inputs with 15 V phantom power, to be activated as required
- Independent paging input, can be routed to each zone
- 4 zone outputs, can be adjusted individually
- Monitor output and record output
- Each microphone/line input with connection for external chime button, 2-tone chime or 4-tone chime or siren (selectable)



- Connection for push-to-talk microphone PA-4000PTT
- Optional connection for up to 32 zone paging microphones PA-4000RC
- Level control via zone VU meter
- Mains operation or 24 V emergency power operation

Model	PA-6040MPX
Frequency range	20-20,000 Hz
Equalizer bass	± 10 dB/100 Hz
Equalizer treble	± 10 dB/10 kHz
S/N ratio	> 65 dB (mic), > 87 dB (line)
THD	< 1%
Power supply	~ 230 V/50 Hz/15 VA, = 24 V/500 mA
Dimensions	482 x 90 x 305 mm, 2 RU
Weight	4.4 kg

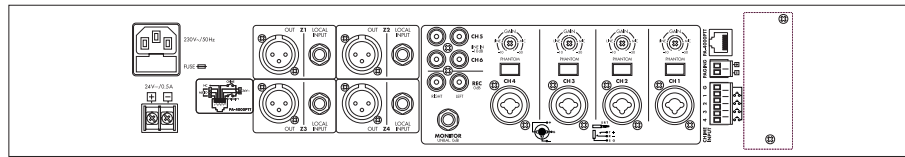

PA-4040MPX

Order No. 0173450



4-zone mixer, for general multi-room PA applications.

- 4 zones with user-defined routing of all input channels
- 3 inputs microphone/line via comb. jacks
- 2 inputs line stereo via RCA jacks
- Each input channel with gain control, 2-way tone control and zone routing switch
- Microphone inputs with 15 V phantom power, to be activated as required
- Priority function for channel 1, switchable
- Independent paging input, can be routed to each zone
- 4 zone outputs, can be adjusted individually
- Connection for monitor speaker
- Level control via VU meters for zone and monitor
- Adjustable headphone output
- Mains operation or 24 V emergency power operation



Model	PA-4040MPX
Frequency range	50-17,000 Hz
Equalizer bass	± 10 dB/100 Hz
Equalizer treble	± 10 dB/10 kHz
S/N ratio	> 65 dB (mic), > 75 dB (line)
THD	< 1%
Power supply	~ 230 V/50 Hz/20 VA, = 24 V/600 mA
Dimensions	482 x 133 x 220 mm, 3 RU
Weight	4.5 kg

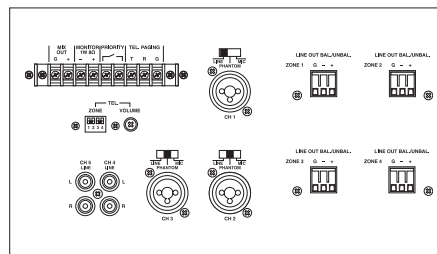

MPX-4PA

Order No. 0202070



3-zone mixer

- 3 zones with user-defined routing of all input channels
- XLR and RCA zone outputs
- 6 input channels (4 stereo ways, 2 microphone ways)
- Both microphone ways can only be routed together
- Recessed gain control for each input channel
- Microphone ways, each with 2-way tone control, talkover and PAD switch
- Stereo channels, switchable 2 x phono/line and 2 x line/line
- Zone outputs, each with 3-way equalizer, LED level display of the stereo master, balance control, pre-fader listening (PFL) and mono/stereo selector switch
- Adjustable headphone output with pre-fader listening (PFL) to the stereo input channels and zone outputs
- Connection for gooseneck light GNL-204



Model	MPX-4PA
Frequency range	20-20,000 Hz
THD	0.1%
S/N ratio	61 dB, unweighted
Equalizer bass	+12 dB, -12 dB/50 Hz
Equalizer midrange	+12 dB, -12 dB/1 kHz
Equalizer treble	+12 dB, -12 dB/10 kHz
Talkover	-16 dB
Power supply	~ 230 V/50 Hz/20 VA
Dimensions	482 x 177 x 105 mm, 4 RU
Weight	4 kg

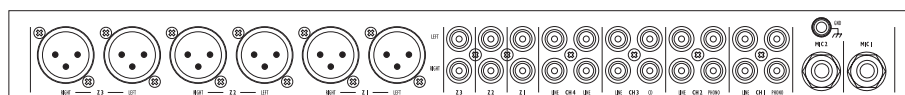



MPX-52PA

Order No. 0202300



- 2-zone mixer, for multi-room PA applications.
- 2 independent zones with user-defined routing of all input channels
- 1 microphone way as announcing channel, balanced, with 3-way equalizer and adjustable automatic talkover

- 4 stereo input channels with stereo line inputs and balanced microphone ways
- Channel 1 additionally with a balanced line input, channels 3 and 4 switchable line/phono
- Signal/peak indication for each channel

Model	MPX-52PA
Mic input	1.5 mV, 5 x 3-pole XLR/6.3 mm jack
Line input	120 mV, 1 x 3-pole XLR L/R, 4 x RCA L/R
Phono input	3 mV, 2 x RCA L/R
Master output	1 V, 2 x 3-pole XLR L/R, 2 x RCA L/R
Record output	550 mV, 2 x RCA L/R
Headphones	≥ 32 Ω, 1 x 6.3 mm jack
Gooseneck lamp	12 V/0.75 W, 1 x BNC
Frequency range	20-20,000 Hz
THD	< 0.1%
S/N ratio	71 dB, unweighted
Equalizer bass	±15 dB/50 Hz
Equalizer midrange	±12 dB/1 kHz
Equalizer treble	±15 dB/10 kHz
Talkover	level attenuation 20 dB max.
Power supply	~ 230 V/50 Hz/15 VA
Dimensions	482 x 138 x 190 mm, 3 RU
Weight	3.9 kg



VMX-440/SW

Order No. 0202530



- 4-channel microphone line mixer
- 2 stereo line inputs
- 2 balanced microphone inputs
- Parallel stereo line input on the front panel
- 3-way equalizer for each microphone input
- Common 2-way tone control for the two line inputs
- Muting via optional momentary push-button/switch

- 2 adjustable stereo master outputs
- Master output level can be preadjusted via trimming potentiometers

Model	VMX-440/SW
Mic input	1 mV/600 Ω, 2 x 6.3 mm jack, bal.
Line input	100 mV/10 kΩ, 3 x RCA L/R
Master output	1-3 V/100 Ω, 2 x RCA L/R
Record output	1 V/100 Ω, 1 x RCA L/R
Headphones	≥ 32 Ω, 2 x 15 mW, 1 x 6.3 mm jack
Frequency range	20-20,000 Hz
THD	0.05%
S/N ratio	> 60 dB
Equalizer bass	± 12 dB/30 Hz
Equalizer midrange	± 12 dB/1 kHz (voice only)
Equalizer treble	± 12 dB/12 kHz
Power supply	~ 230 V/50 Hz/10 VA
Dimensions	482 x 45 x 180 mm, 1 RU
Weight	2.25 kg

MXT-52MP3

Order No. 0176790



Mixer with integrated MP3 player,

for flush-mounting into walls.

- 2 balanced microphone/line inputs (XLR), each with gain control and selectable phantom power
- 2 line inputs (RCA L/R)
- 1 aux input (3.5 mm jack)
- Integrated MP3 player with USB interface and SD/MMC card slot, including remote control
- Each input with level control
- Output with 2-way tone control and level control
- LED for indicating clip and operating status
- Metal housing with rear cover for protection against dirt



Model	MXT-52MP3
Mic input	1 mV, 2 x XLR, bal.
Line input	230 mV, 2 x XLR, bal. 160 mV, 2 x RCA L/R
Aux input	160 mV, 1 x 3.5 mm jack
Master output	1-10 V, terminal, mono, bal.
Frequency range	20-20,000 Hz
THD	< 0.03%
S/N ratio	> 78 dB
Equalizer bass	±10 dB/100 Hz
Equalizer treble	±10 dB/12 kHz
Power supply	=/- 24 V/250 mA
Dimensions	200 x 160 x 90 mm
Weight	1.25 kg

RACK-MXT52MP3

Order No. 1000736



Wall-mounted housing, for mounting the mixer with integrated MP3 player MXT-52MP3

- Sheet steel version
- Light grey powder coating (RAL 7035)
- Attached hinged cover, opens downwards, non-removable, lockable
- Round rear panel cutout (40 mm) for cable inlet
- Two round cutouts at the top (16 mm) for cable inlet, high-strength cable gland possible
- Two round cutouts at the bottom (16 mm) for cable inlet, high-strength cable gland possible
- Max. mounting depth behind the front panel: 74 mm



Signal Processing

Signal Optimisation

PA-1200M

Order No. 0240260



Monitor unit, 10 + 1 channels

- Audio sources can be selected via rotary switch
- 10 monitor inputs 1-100 V/10 k Ω
- 1 aux input 0 dB (0.775 V)/600 Ω
- Level control, LED VU meter and clip LED for each monitor input
- Built-in 2 W speaker, volume control
- Headphone output
- Mains operation and 24 V emergency power operation



Model	PA-1200M
Power rating	2 W
Inputs	1-100 V/10 k Ω (monitor) 0.775 V/600 Ω (aux)
Frequency range	100-20,000 Hz
THD	< 0.3%
Power supply	~ 230 V/50 Hz/15 VA, = 24 V/0.5 A
Dimensions	482 x 88 x 200 mm
Weight	4.7 kg
Connections	screw terminals (monitor input 1-10), screw terminals (aux input), 6.3 mm jack (headphones)

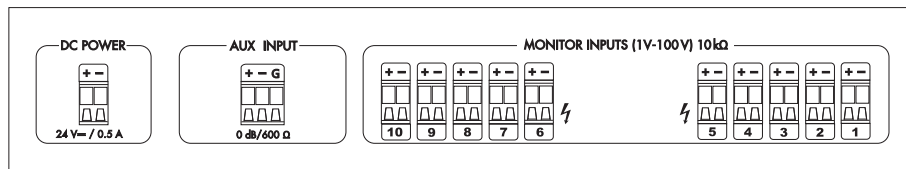

PA-24AD

Order No. 0171890



10-way PA line splitter

- 2 separate inputs
- Stereo operation or mono operation
- Balanced XLR connection for each input and output
- Gain control for each output
- Peak indication for each input
- Mains operation and 24 V emergency power operation



Model	PA-24AD
Frequency range	20-20,000 Hz
Input signal	0.775 V
Input impedance	15 k Ω
Output signal	0.775 V
Output impedance	600 Ω
S/N ratio	> 68 dB
THD	< 0.05%
Power supply	~ 230 V/50 Hz/10 VA, = 24 V/0.2 A
Dimensions	482 x 45 x 235 mm, 1 RU
Weight	2.9 kg
Inputs	2 x XLR
Outputs	10 x XLR

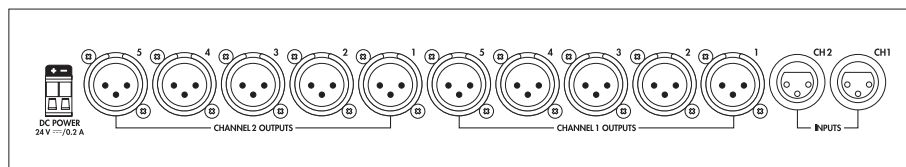

PA-1414MX

Order No. 0174770



10-channel PA preamplifier

- 5 XLR input channels, switchable mic/line
- 4 input channels, switchable XLR mic/RCA line
- 2 XLR master outputs
- 1 record output (master1, master2)
- Input channels with level control and output selector switch (master1, master1+2, master2)
- Each master output with 2-way tone control
- Chime button with priority circuit, remote control possible, 2-tone chime or 4-tone chime, siren (selectable)
- 1 push-to-talk connection, RJ45, with priority circuit (suitable for PA-4000PTT)

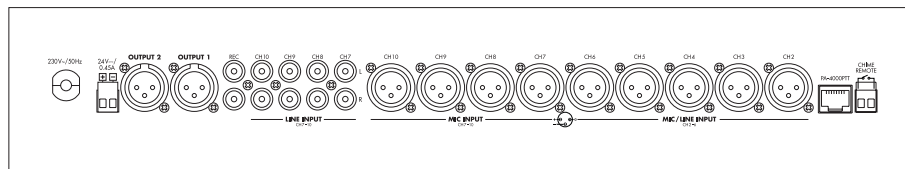

Model	PA-1414MX
Inputs	2.5 mV, bal. (mic), 250 mV, bal. (line XLR), 250 mV, unbal. (line RCA)
Frequency range	20-20,000 Hz (-0.5 dB)
Equalizer bass	± 10 dB/100 Hz
Equalizer treble	± 10 dB/10 kHz
S/N ratio	> 60 dB (mic), > 75 dB (line)
THD	< 0.05%
Power supply	~ 230 V/50 Hz/15 VA, = 24 V/0.5 A
Dimensions	482 x 45 x 240 mm, 1 RU
Weight	2.5 kg
Connections	9 x XLR (mic/line inputs), 4 x RCA L/R (line inputs), 1 x RJ45 (push-to-talk microphone), 2 x XLR (outputs), 1 x RCA L/R (record output)

MFE-212

Order No. 0254520



Stereo DSP feedback controller

- Prevents acoustic feedback appearing in PA systems
- 12 steep-edged precision notch filters for each stereo channel
- Editable filter parameters (supplied with software)
- 4 factory presets, 16 user presets
- Mono operation or 2-channel operation possible
- AD/DA resolution: 24 bits
- 45 dB attenuation (with gradual reduction in variable mode)
- Optionally continuous signal monitoring (auto notch) or manual setting of the required filters (manual notch)
- Backlit 2 x 20 dot matrix display
- Adjustable input level and output level
- Bypass function
- Clip LED
- Balanced inputs and outputs: XLR and 6.3 mm jack
- USB port (Type-A)
- MIDI input and output
- 482 mm (19") rack installation, 1 RU

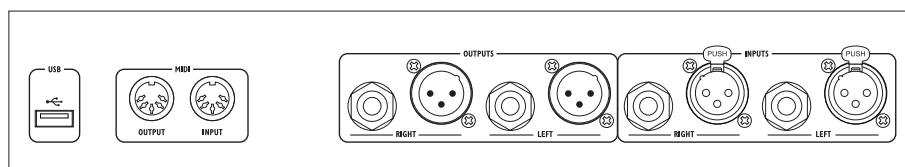

Model	MFE-212
Frequency range	20-20,000 Hz
Input signal	2.2 V max.
Output signal	2.2 V max.
S/N ratio	> 90 dB
THD	< 0.01%
Power supply	~ 230 V/50 Hz/20 VA
Dimensions	482 x 44 x 193 mm, 1 RU
Weight	2 kg
Inputs	1 x XLR L/R, bal. (line) 1 x 6.3 mm jack L/R (line)
Outputs	1 x XLR L/R, bal. (line) 1 x 6.3 mm jack L/R (line)
Other features	MIDI in/out (2 x 5-pole DIN) USB Type-A jack

MCX-200/SW

Order No. 0244170



Electronic stereo crossover network

- Subwoofer operation/satellite operation
- Additional mono subwoofer output
- Output level can be adjusted individually for each frequency range
- Switchable phase for subwoofer output
- Adjustable crossover frequency
- Ground lift switch
- All connections via 6.3 mm jacks, unbal.

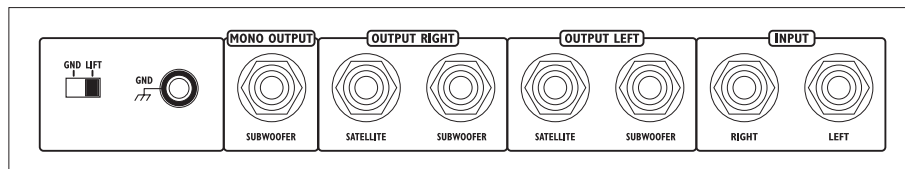

Model	MCX-200/SW
Frequency range	10-30,000 Hz, -0.5 dB
Crossover frequency	60-500 Hz, 12 dB/oct.
High-pass filter	15 Hz, 12 dB/oct.
THD	< 0.03%
Inputs	6 V max./56 kΩ
Outputs	6 V max./100 Ω (±10 dB)
S/N ratio	> 80 dB
Power supply	~ 230 V/50 Hz/5 VA
Admiss. ambient temp.	0-40 °C
Dimensions	482 x 44.5 x 185 mm, 1 RU
Weight	2 kg



VCA-202

Order No. 0171880



Voltage-controlled 2-channel VCA volume control

- 2-channel mono operation or stereo operation
- Remote control for each channel via optional wall-mounted volume control VCA-202RN or via lin. 10 k Ω potentiometer (not supplied), control voltage: = 0-10 V
- 10 V voltage output for potentiometer
- Servo-balanced inputs and outputs
- 482 mm (19") rack installation, 1 RU



For the remote volume control of PA systems in large areas (e.g. houses of worship, workshops). The volume control VCA-202 is inserted between preamplifier and power amplifier.

The surface-mounted housing ATT-300 can be used for universal mounting of the potentiometers.

Model	VCA-202
Line input	1 V/30 k Ω
Input control voltage	= 0-10 V/100 k Ω
Line output	1 V/600 Ω
Output control voltage	= 10 V/5 mA
Frequency range	20-20,000 Hz
THD	0.1%
S/N ratio	70 dB
Power supply	~ 230 V/50 Hz/10 VA
Dimensions	482 x 48 x 105 mm, 1 RU
Weight	1.5 kg

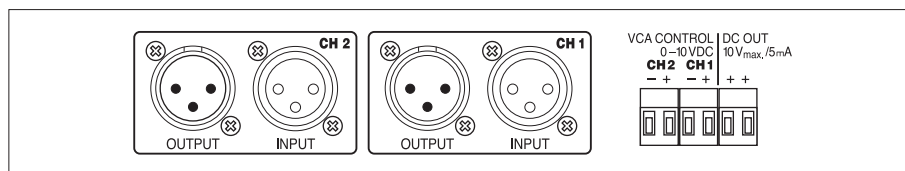

VCA-202RN

Order No. 0173000

Wall-mounted volume control, for use with VCA-202 or similar applications.

- Linear 10 k Ω potentiometer, mono
- Built-in relay (= 24 V) for priority circuit
- Flush mounting into standard 60 mm wall socket
- Surface mounting with matching housing ATT-300, available at option
- Mounting depth: 27 mm
- Plug-in screw terminal



SLA-35

Order No. 0214010

Stereo level and impedance matching amplifier

Volume distortions or volume losses may occur when connecting smartphones, mobile phones, tablet PCs and MP3 players to an amplifier or a mixer. The SLA-35 is able to provide a better sound by means of correctly setting impedance and gain.

- Adjustable attenuation down to 1/10 (-20 dB) or gain up to 10-fold (+20 dB)
- Impedance switching Hi/Lo
- RCA and 3.5 mm stereo inputs and outputs
- Metal housing
- Supplied with plug-in power supply

Model	SLA-35
Frequency range	3-50,000 Hz
Input signal	7 V max.
Input impedance	35 k Ω /8.1 k Ω (switch -5.6 dB)
Output signal	max. 4.5 V/1.6 k Ω
Gain	0.1-10 (\pm 20 dB) continuously adjustable, additionally -5.6 dB, switchable
S/N ratio	> 83 dB
Channel separation	> 68 dB
THD	< 0.03%
Power supply	via encl. power supply
Dimensions	88 x 37 x 103 mm
Weight	450 g



Signal Processing

Volume Control

ILA-100RCA

Order No. 0212900

Passive stereo level control (RCA version)

- 1 x stereo RCA input, 1 x 3.5 mm stereo input
- 1 x stereo RCA output, 1 x 3.5 mm stereo output
- Large, easy-turning level control
- Mute button
- Frequency range: 20-20,000 Hz
- Passive, no power supply required

- High-quality metal console housing with brushed aluminium front panel
- Dimensions: 142 x 60 x 86 mm
- Weight: 300 g



ILA-100XLR

Order No. 0212910

Passive stereo level control (XLR version)

- 2 x balanced comb. input (XLR/6.3 mm jack), 1 x 3.5 mm stereo input
- 2 x balanced XLR output, 1 x 3.5 mm stereo output
- Large, easy-turning level control
- Mute button
- Frequency range: 20-20,000 Hz

- Passive, no power supply required
- High-quality metal console housing with brushed aluminium front panel
- Dimensions: 142 x 60 x 86 mm
- Weight: 300 g



ATT-1950

Order No. 0171370



ATT-19100

Order No. 0172640



6-way PA volume controls for 482 mm (19") rack installation

- 6 audio transformers for 100 V line technique
- Connection for priority circuit, 6 priority relays (= 24 V/20 mA)
- Attenuation in 10 steps, position 0 is OFF
- Aluminium front panel
- Available in 3 power classes
- Plug-in screw terminal

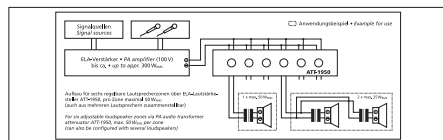
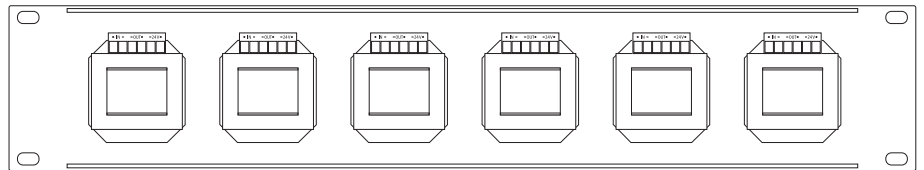
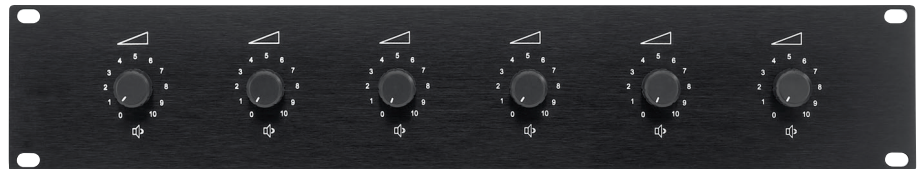

Model	ATT-1950	ATT-19100
Frequency range	50-18,000 Hz	50-18,000 Hz
Power rating	6 x 50 W	6 x 100 W
Priority facility	yes	yes
Dimensions	484 x 88 x 77 mm, 2 RU	484 x 88 x 77 mm, 2 RU
Weight	1.379 kg	2 kg

ATT-442ST

Order No. 0171860

4-channel speaker volume control, stereo

Particularly high quality due to transformer technology with universal output assignment (4-16 Ω for each speaker), 20-20,000 Hz, attenuation in 10 steps for each pair, position 0 is OFF.

- 2 stereo inputs (100 W max. for each channel) and 4 stereo speaker outputs (18 W/4-16 Ω each)
- Source selector switch for each speaker output
- Screw terminals
- Black metal housing
- Dimensions: 432 x 78 x 190 mm
- Weight: 3.4 kg

With this device, it is finally possible to adjust the level of several pairs of speakers (up to 4) independently, even without 100 V line technique and connect them together to basic amplifiers without any problems.

Even speaker systems with different impedances between 4 and 16 Ω can be mixed as desired. Ideally suited for restaurants and bars.

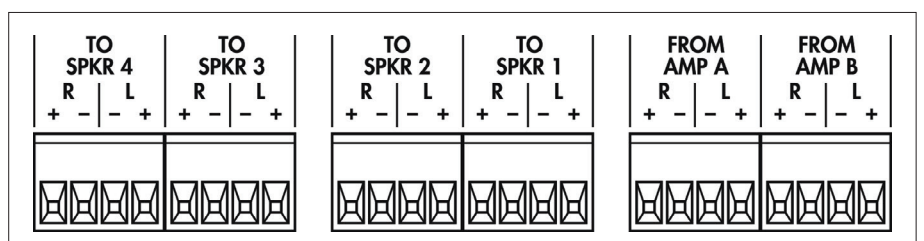

Wall-mounted PA Volume Controls with 24 V Emergency Priority Relay

- Attenuation in 10 steps, position 0 is OFF
- For 100 V line technique
- White plastic front panel and knob
- Also suitable for already existing series of switches with standard cover frames (cutout: 50 mm or 55 mm)
- Flush mounting into standard 60 mm wall sockets (ATT-5100PEU into 65 mm wall socket)
- Plug-in screw terminal



Model	Order No.	Frequency range	Power rating	Priority facility	Dimensions	Mounting depth	Weight	Surface-mounted housing
ATT-506PEU	0173890	50-18,000 Hz	6 W	yes	80 x 80 x 67 mm	45 mm	212 g	-
ATT-512PEU	0173900	50-18,000 Hz	12 W	yes	80 x 80 x 67 mm	45 mm	222 g	-
ATT-524PEU	0173910	50-18,000 Hz	24 W	yes	80 x 80 x 66 mm	45 mm	231 g	-
ATT-5100PEU	0173940	50-18,000 Hz	100 W	yes	80 x 80 x 70 mm	50 mm	342 g	-

Wall-Mounted PA Volume Controls with 24 V Emergency Priority Relay

- Attenuation in 10 steps, position 0 is OFF
- For 100 V line technique
- Snow-white plastic front panel and knob
- Flush mounting into standard 65 mm wall sockets (except ATT-3100PEU)
- Surface mounting with matching housing ATT-300, available at option
- Plug-in screw terminal



Model	Order No.	Frequency range	Power rating	Priority facility	Dimensions	Mounting depth	Weight	Surface-mounted housing
ATT-306PEU	0173690	50-18,000 Hz	6 W	yes	80 x 80 x 67 mm	45 mm	97 g	ATT-300
ATT-312PEU	0171380	50-18,000 Hz	12 W	yes	80 x 80 x 67 mm	45 mm	168 g	ATT-300
ATT-324PEU	0171390	50-18,000 Hz	24 W	yes	80 x 80 x 67 mm	45 mm	175 g	ATT-300
ATT-336PEU	0171400	50-18,000 Hz	36 W	yes	80 x 80 x 67 mm	45 mm	234 g	ATT-300
ATT-350PEU	0171410	50-18,000 Hz	50 W	yes	80 x 80 x 67 mm	45 mm	233 g	ATT-300
ATT-3100PEU	0172630	50-18,000 Hz	100 W	yes	80 x 80 x 67 mm	45 mm	335 g	ATT-300

Wall-Mounted PA Volume Controls

- Attenuation in 10 steps, position 0 is OFF
- Audio transformer for 100 V line technique
- White plastic front panel and knob
- Flush mounting, surface mounting with matching housing ATT-200, available at option



Model	Order No.	Frequency range	Power rating	Priority facility	Dimensions	Mounting depth	Weight	Surface-mounted housing
ATT-212/WS	0173670	50-18,000 Hz	12 W	no	85 x 85 x 66 mm	42 mm	156 g	ATT-200
ATT-224/WS	0173680	50-18,000 Hz	24 W	no	85 x 85 x 66 mm	38 mm	154 g	ATT-200
ATT-235/WS	0170580	50-18,000 Hz	35 W	no	85 x 85 x 71 mm	42 mm	212 g	ATT-200
ATT-250/WS	0170590	50-18,000 Hz	50 W	no	85 x 85 x 71 mm	42 mm	211 g	ATT-200
ATT-2100/WS	0172610	50-18,000 Hz	100 W	no	85 x 85 x 71 mm	42 mm	260 g	ATT-200

Wall-mounted PA volume controls

- Recessed control to prevent unintentional readjustment
- Attenuation in 11 steps and OFF
- Audio transformer for 100 V line technique
- White plastic front panel (removable) and knob
- Flush mounting in standard hollow wall boxes
- Surface mounting with matching housing ATT-200, available at option

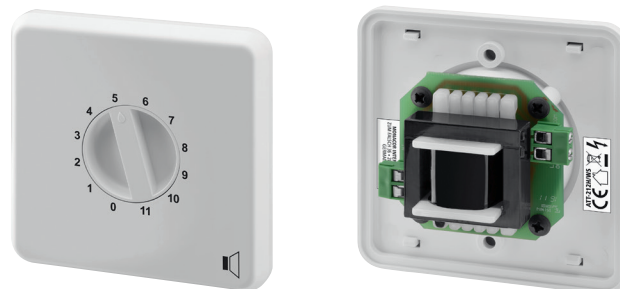

Model	Order No.	Frequency range	Power rating	Priority facility	Dimensions	Mounting depth	Weight	Surface-mounted housing
ATT-212H/WS	0176110	50-18,000 Hz	12 W	no	85 x 85 x 43 mm	35 mm	150 g	ATT-200
ATT-224H/WS	0176120	50-18,000 Hz	24 W	no	85 x 85 x 45 mm	37 mm	160 g	ATT-200
ATT-235H/WS	0176130	50-18,000 Hz	35 W	no	85 x 85 x 45 mm	34 mm	155 g	ATT-200
ATT-250H/WS	0176140	50-18,000 Hz	50 W	no	85 x 85 x 50 mm	42 mm	257 g	ATT-200
ATT-2100H/WS	0176150	50-18,000 Hz	100 W	no	85 x 85 x 50 mm	42 mm	250 g	ATT-200

Wall-mounted PA volume control with programme selector and 24 V emergency priority relay

relay

- Attenuation in 10 steps, position 0 is OFF
- Switches one of 6 signal sources to one speaker output (programme)
- For 100 V line technique
- Snow-white plastic front panel and knob
- Flush mounting into standard 65 mm wall sockets
- Surface mounting with matching housing ATT-400, available at option
- Plug-in screw terminals

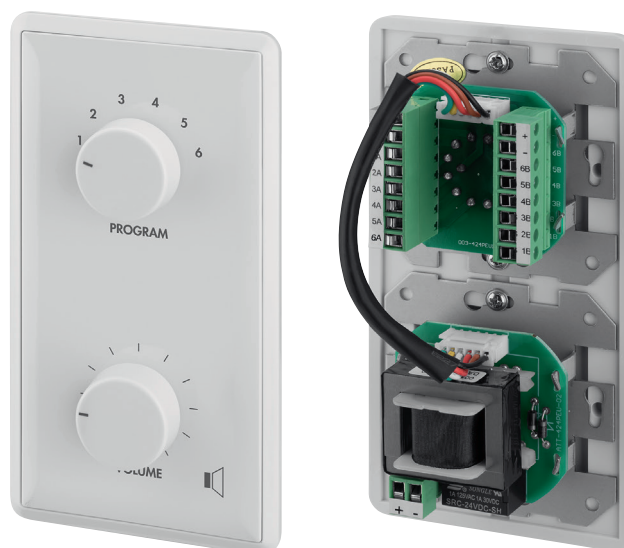

Model	Order No.	Frequency range	Power rating	Priority facility	Dimensions	Mounting depth	Weight	Surface-mounted housing
ATT-412PEU	0171460	50-18,000 Hz	12 W	yes	80 x 154 x 68 mm	45 mm	280 g	ATT-400
ATT-424PEU	0171470	50-18,000 Hz	24 W	yes	80 x 154 x 68 mm	45 mm	290 g	ATT-400

ATT-306

Order No. 0171420

PA programme selector

- Switches one of 6 signal sources to one speaker output
- For 100 V audio technique or other signals
- Built-in relay (24 V) for priority circuit
- Snow-white plastic front panel and knob
- Flush mounting into standard 65 mm wall sockets

Model	ATT-306
Priority facility	yes
Dimensions	80 x 80 x 57 mm
Mounting depth	35 mm
Weight	111 g



ATT-325ST

Order No. 0171430

Stereo volume control, of high-quality transmitting technology.

- 4 Ω amplifier input and 4 Ω speaker output
- Power rating: 25 W per channel
- Attenuation in 10 steps, position 0 is OFF
- Snow-white plastic front panel and knob
- Surface mounting with matching housing ATT-300, available at option

Model	ATT-325ST
Frequency range	20-20,000 Hz
Power rating	25 W
Dimensions	80 x 80 x 73 mm
Mounting depth	50 mm
Weight	277 g
Surface-mounted housing	ATT-300



ATT-200

Order No. 0170550

Surface-mounted housing

- For wall-mounted PA volume controls of the 200 series with 2-hole fixing
- Also suitable as protective housing for flush mounting
- White plastic



ATT-200P

Order No. 0170870

Front panel, white, plastic

- For universal mounting in combination with surface-mounted housing ATT-200
- Without imprint
- With drill hole Ø 9.0 mm



ATT-300C

Order No. 0176430

Flush-mounted housing

- For wall-mounted PA volume controls of the series ATT-3...PEU
- Combinable
- Grey-transparent plastic



ATT-300

Order No. 0171440

Surface-mounted housing

- For wall-mounted PA volume controls of the series ATT-3...PEU
- Snow-white plastic



ATT-400

Order No. 0171450

Surface-mounted housing

- For wall-mounted PA volume controls with programme selector of the series ATT-4...PEU
- Snow-white plastic



ATT-500PD

Order No. 0173880

Mounting frame

- For all panel jacks of the D series from NEUTRIK
- Flush mounting into standard 60 mm wall sockets
- Also suitable for already existing series of switches with standard cover frame



- (50 mm or 55 mm cutout)
- Dimensions: 80 x 80 x 10 mm
- Supplied with mounting screws

100 V High-performance Audio Transformers

- An external 100 V transformer is necessary for an amplifier or speaker without installed 100 V audio transformer
- Each of the offered 100 V audio transformers can be used

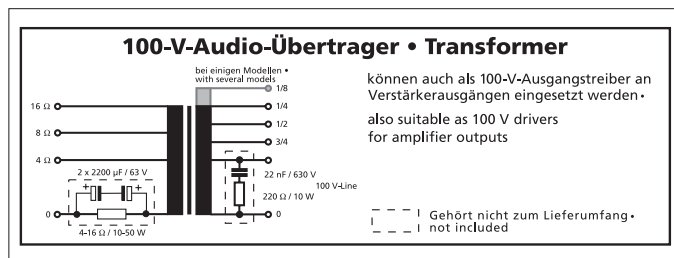
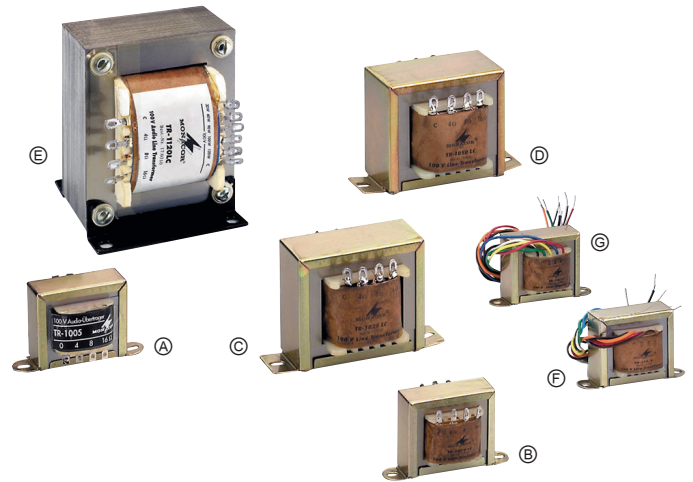

Model	Order No.	Power	Primary	Secondary	Frequency range	Dimensions	Weight	Position
TR-1005	0170230	10 W	10/5/2.5/1.25/0.625 W	4/8/16 Ω	40-30,000 Hz	71 x 43 x 41 mm	276 g	A
TR-1010LC	0170250	10 W	10/7.5/5/2.5 W	4/8/16 Ω	35-20,000 Hz	71 x 43 x 38 mm	271 g	B
TR-1025LC	0170270	25 W	25/20/12/6 W	4/8/16 Ω	25-20,000 Hz	92 x 60 x 52 mm	752 g	C
TR-1050LC	0170290	50 W	50/37.5/25/12.5 W	4/8/16 Ω	30-15,000 Hz	92 x 60 x 58 mm	860 g	D
TR-1120LC	0170310	120 W	120/100/90/60/30 W	4/8/16 Ω	20-20,000 Hz	72 x 99 x 78 mm	2,060 g	E
TR-175/6	0170440	6 W	6/4/2/1 W	4/8/16 Ω	28-25,000 Hz	71 x 42 x 40 mm	273 g	F
TR-175/10	0170450	10 W	10/6/4/2/1 W	4/8/16 Ω	35-25,000 Hz	71 x 42 x 40 mm	287 g	G

100 V Toroidal Audio Transformers

- Very high-quality version with a perfect frequency response and extra low THD
- Flat design
- Sealed



Model	Order No.	Power	Primary	Secondary	Frequency range	Dimensions	Weight
TR-520	0171920	20 W	5/10/15/20 W	4 Ω	80-18,000 Hz	Ø 60 mm x 30 mm	348 g
TR-525	0171210	5 W	2.5/5 W	4 Ω	80-18,000 Hz	Ø 50 mm x 20 mm	155 g

PATL-100/XC

Order No. 1000092

- 100 V transformer**, for connecting a 100 V audio signal source to devices with line input.
- Adjustable line output level (0-5.6 V at 100 V input voltage), can be switched internally for other output voltages
 - 100 V input with plug-in screw terminal

- Balanced XLR output, impedance: 1 kΩ, XLR panel plug
- RCA output
- Insulated plastic housing
- Galvanically isolated input and output
- Dimensions: 100 x 60 x 190 mm
- Weight: 625 g



ATT-20

Order No. 0034500

Rotary knob, white

- For shafts Ø 6 mm, 18 teeth
- Suitable for PA volume controls ATT-.../WS
- Diameter: approx. 20 mm
- Height: approx. 17 mm



LKB-1

Order No. 0161830

Connection terminal, for 100 V PA speakers.

- 3-pole ceramic screw terminal
- Thermal fuse 1 A/150 °C for disconnecting a faulty speaker in case of a short circuit (fire), so that the function of one speaker line is maintained
- Dimensions: 35 x 20 x 20 mm



SPS-80S

Order No. 0211750

Speaker switch box

- For connecting up to 8 pairs of speakers (4-8 Ω) in any combination to 1 stereo amplifier output
- With built-in power protective resistors
- Music power: 300 W
- Dimensions: 310 x 60 x 115 mm



• Weight: 1.1 kg

SPS-40S

Order No. 0210390

Speaker switch box

- For connecting up to 4 pairs of speakers (4-8 Ω) in any combination to 1 stereo amplifier output
- With built-in power protective resistors
- Music power: 200 W



SPS-20S

Order No. 0210670

Speaker switch box

- For connecting up to 2 pairs of speakers (4-8 Ω) in any combination to 1 stereo amplifier output
- Music power: 200 W
- Dimensions: 176 x 50 x 100 mm
- Weight: 430 g



SPS-41A

Order No. 0210410

Stereo line switch box

- 4 line sources to 1 amplifier line input
- RCA inputs and RCA outputs
- Metal housing
- Dimensions: 126 x 58 x 108 mm
- Weight: 335 g



MMX-8

Order No. 0242860

Miniature universal audio mixer

- 8 mono channels, switchable mic/line
- Selection of 4 stereo channels
- 2 output level controls, 2 peak LEDs
- Supplied w/o battery



VB-202A

Order No. 0181020

Passive 2-wire transmission set, for audio signals.

- Audio transmission via one pair of wires of a Cat. 5 cable, 1,000 m max.
- Transmission range: 20-20,000 Hz
- RCA connections
- Cable connection via screw terminals



LPC-1

Order No. 0210600

Line/phono adapter

- Input: 2 x RCA, 56 kΩ/1 kHz
- Output: 2 x RCA, 560 Ω/1 kHz
- Dimensions: 37 x 53 x 22 mm
- Weight: 48 g
- No power supply required



SMC-1

Order No. 0211930

Stereo/mono converter

- 1 x stereo to 2 x mono
- Input impedance: 4.7 kΩ
- Connections: input 1 x RCA L/R, output 2 x RCA mono
- Dimensions: 65 x 22 x 37 mm



PREAMP-1UP

Order No. 0171350

Flush-mounted preamplifier

- For connection of power amplifiers
- Fitted metal base plate
- Connections and level controls for line input and microphone input

Model	PREAMP-1UP
Line input	400 mV (line) 4 mV (mic)
Input control voltage	= 0-10 V
Line output	5 V max./50 Ω
Frequency range	20-20,000 Hz (line) 40-15,000 Hz (mic)
Power supply	= 22-26 V/0.025 A
Connections	7-pole terminal strip, removable 1 x RCA L/R (line) 1 x 6.3 mm jack (mic)



EVAB-22

Order No. 1000715



Speaker switch-on delay

Loud crackling or even a bang-like sound may be heard from the connected speakers when switching an audio system with audio players, preamplifier and power amplifier on or off using a central switch. This is caused by a charge potential passing through electrolytic capacitors in the signal path of the preamplifier when switched on. The EVAB-22 can prevent this unpleasant effect. For this purpose, the device is inserted into the signal path between preamplifier (or signal source) and power amplifier. The EVAB-22 delays the connection of the signal source to the power amplifier when switching the system on. The turn-on pulse does not reach the power amplifier. When the system is turned off, the signal path to the power amplifier is disconnected immediately, before a turn-off pulse can reach the power amplifier via the signal path.

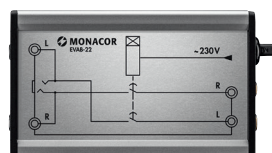

- 1 x RCA input L/R
- 1 x 3.5 mm stereo jack input
- 1 x RCA output L/R
- Metal housing

FGA-30

Order No. 0212430

Ground isolator

- Prevents hum loops
- 2 RCA jacks
- 3.5 mm stereo plug



FGA-30M

Order No. 0213010

Ground isolator

- Prevents hum loops
- 2 RCA plugs
- 3.5 mm stereo plug



FGA-35

Order No. 0212420

Ground isolator

- Prevents hum loops
- 2 x 3.5 mm stereo plug



FGA-40MF

Order No. 0213050

Ground isolator

- Prevents hum loops
- 2 RCA jacks
- 2 RCA plugs



FGA-40HQ

Order No. 0066380

High-end ground isolator

- For preventing signal interference and hum loops which may occur, e.g. when connecting the car radio to an amplifier
- Gold-plated RCA jacks



FGA-40

Order No. 0064370

Ground isolator

- For preventing signal interference and hum loops which may occur, e.g. when connecting the car radio to an amplifier
- RCA plugs and RCA jacks



SPOTTUNE
OmniExperience™

reddot winner 2021

GERMAN INNOVATION AWARD 21 WINNER

www.monacor-international.com/spottune

Innovative Wireless Audio Solutions with 360° sound radiation

The plug-and-play sound system
for lighting systems

MONACOR
INTERNATIONAL

THE AUDIO COMPANY

SAM-500D

Order No. 0320800



Class D active subwoofer module, 500 W at 4 Ω

- High-performance active module in class D technology
- Variable low-pass filter: 40-200 Hz (18 dB)
- Continuously adjustable phase control 0-180° for perfectly matching it to the main speakers
- Line input, par. line output
- Integrated bass boost of approx. 3 dB at 40 Hz
- High-level inputs for parallel connection to the speaker cables
- Very high power reserves for bass speakers with a diameter up to 46 cm

Model	SAM-500D
Peak output power	700 W
Power rating	500 W
Power rating at 4 Ω	500 W
Power rating at 8 Ω	250 W
Inputs	max. 7 V/22 kΩ
Attenuation factor	25.0
Frequency range	20 Hz - (var. 40-200 Hz)
S/N ratio	> 70 dB
THD	< 1%
Power consumption, standby	< 0.5 W
Dimensions	251 x 270 x 90 mm
Weight	2.6 kg
Connections	1 x RCA (line in), 1 x speaker terminal (high power in), 1 x RCA (line out)



SAM-300D

Order No. 0320790



Class D active subwoofer module, 300 W at 4 Ω

- High-performance active module in class D technology
- Variable low-pass filter: 40-200 Hz (18 dB)
- Continuously adjustable phase control 0-180° for perfectly matching it to the main speakers
- Line input, par. line output
- Integrated bass boost of approx. 3 dB at 40 Hz
- High-level inputs for parallel connection to the speaker cables
- High power reserves

Model	SAM-300D
Peak output power	420 W
Power rating	300 W
Power rating at 4 Ω	300 W
Power rating at 8 Ω	150 W
Inputs	max. 7 V/22 kΩ
Attenuation factor	24.4
Frequency range	20 Hz - (var. 40-200 Hz)
S/N ratio	> 70 dB
THD	< 0.1%
Power supply	~ 230 V/50 Hz/440 VA
Power consumption, standby	< 0.5 W
Dimensions	188 x 255 x 90 mm
Weight	1.3 kg
Connections	1 x RCA (line in), 1 x speaker terminal (high power in), 1 x RCA (line out)



SAM-200D

Order No. 0320780



Class D active subwoofer module, 200 W at 4 Ω

- High-performance active module in class D technology
- Variable low-pass filter: 40-200 Hz (18 dB)
- Continuously adjustable phase control 0-180° for perfectly matching it to the main speakers
- Line input, par. line output
- Integrated bass boost of approx. 3 dB at 40 Hz
- High power reserves

Model	SAM-200D
Peak output power	280 W
Power rating	200 W
Power rating at 4 Ω	200 W
Power rating at 8 Ω	100 W
Inputs	max. 7 V/20 kΩ
Attenuation factor	26.6
Frequency range	20 Hz - (var. 40-200 Hz)
S/N ratio	> 70 dB
THD	< 0.1%
Power supply	~ 230 V/50 Hz/330 VA
Power consumption, standby	< 0.5 W
Dimensions	178 x 204 x 80 mm
Weight	1.05 kg
Connections	1 x RCA (line in), 1 x RCA (line out)



SAM-2

Order No. 0320670



Active subwoofer module, 200 W

- High-performance active module
- 24 dB subsonic filter
- Variable low-pass filter: 50-150 Hz (18 dB)
- Semiparametric bass boost (variable 30-50 Hz midrange with boost up to 6 dB, continuously adjustable)
- Continuously adjustable phase control 0-180° for perfectly adapting to the room and setup
- Variable high-pass filter: 50-150 Hz (12 dB) for equalizing the bass frequencies of the satellite amplifier and the satellite speakers
- Ground lift switch from the studio technology to prevent hum interference
- Various protective circuits against short circuit, overheating and DC voltage overload

Model	SAM-2
Peak output power	250 W
Power rating	200 W
Power rating at 4 Ω	200 W
Power rating at 8 Ω	125 W
Inputs	8.4 V mono/4.2 V stereo/20 kΩ (line) 44 V stereo/17 kΩ (high)
Frequency range	satellite: (var. 50-150 Hz) - 20,000 Hz subwoofer: 20 Hz - (var. 50-150 Hz)
S/N ratio	> 70 dB
THD	< 0.1%
Power supply	~ 230 V/50 Hz/300 VA
Power consumption, standby	6 VA
Dimensions	185 x 370 x 90 mm
Weight	4.9 kg

- Perfect drive for bass speakers with a diameter of up to 46 cm
- Impressive sound and workmanship





EVA-16/2

Order No. 0176710



Audio management controller, for PA applications and evacuation complying with EN 54-16 certification for voice alarm systems (VAS) according to DIN EN 60849 (VDE 0828) and DIN VDE 0833-4.

As a central controller, EVA-16/2 is used for managing and monitoring microphone announcements, emergency announcements and stored evacuation announcements, any required music feeds and for a reliable reproduction of chimes and sirens.

Furthermore, EVA-16/2 is also monitoring connected power amplifiers as well as a possible emergency power supply. Connected speaker lines are also monitored for disconnection, impedance deviation as well as for short-circuit and earth fault.

For an easy and convenient operation, controller EVA-16/2 is equipped with the following features and functions:

- 11.5 cm (4.5") colour touch panel/display
- Real time clock with extensive error and event logging
- Protected slot for SD card on the front panel
- Integrated audio monitor/monitor speaker
- Extended BUS function

EVA-16/2 to be used as a master controller for individual projects and in master/slave for more complex projects, can be cascaded to up to 10 systems.

- Monitoring of the amplifiers with emergency switching (8 amplifiers and 1 spare amplifier)
- Monitoring of up to 8 speaker lines in A/B cabling (16 testing circuits)
- 2 x fireman's microphone can be connected on the rear panel
- Up to 16 monitored system microphone stations EVA-16TER/2 or EVA-16SYS80/2 can be connected
- 4 audio inputs with free assignment/distribution of the audio input signals
- 2 additional audio inputs (AUX)
- 4 transformer-balanced AF outputs + 1 output for backup amplifier with free assignment of the different audio devices
- Digital voice memory for alarm announcements
- Tone control and volume control for each amplifier channel
- Extensive inputs and outputs for controlling and signalling
- RS-232 interface for programming or updating via a PC
- 482 mm (19") rack installation, 2 RU
- Mains operation and 24 V emergency power operation

Model	EVA-16/2
Power supply	~ 230 V/50 Hz/25 VA, = 24 V/600 mA
Admiss. ambient temp.	-5 °C to +55 °C
Dimensions	483 x 88 x 302 mm
Weight	5.9 kg

EVA-16TER/2

Order No. 0230640



System microphone station, according to DIN EN 60849 (VDE 0828).

- Microprocessor-controlled system microphone station, especially for connection to audio management controller EVA-16/2 with EN 54-16 certification
- For announcements in up to 80 speaker circuits, to be selected as desired
- Built-in LCD for indicating the respective operating status
- Separate emergency button
- Individual programming of selective, group, collective and emergency announcements with the respective priority level
- Concealed buttons for pre-alarm, building evacuation, music (on/off),



- fault indication with attention signal
- Connection via RJ45 jack

EVA-16SYS80/2

Order No. 0230630



System microphone station, according to DIN EN 60849 (VDE 0828).

- Microprocessor-controlled system microphone station, especially for connection to audio management controller EVA-16/2 with EN 54-16 certification
- For announcements in up to 80 speaker circuits (to be selected as desired); partly monitored, depending on the programming
- Built-in two-line LCD for indicating the respective operating status
- Separate emergency button
- Individual programming of selective call and group call with the respective priority levels
- Connection via RJ45 jack



EVA-16FP/2

Order No. 0176670



PA fireman's microphone, for audio management system EVA-16/2 with EN 54-16 certification.

This fireman's microphone station has especially been developed for emergency services according to the standards DIN EN 60849 (VDE 0828), EN 54-16 or DIN 14661 in order to organise a safe and systematic evacuation of people in case of an alarm.

- Supplied with hand-held PA microphone MEVAC-1FH
- 4 alarm zones
- 4 fireman's microphone stations
- Robust red sheet steel housing for wall mounting



- Relay fire alarm control panel (FACP): 24 V/2 k Ω
- Relay contact ERROR: ~ 120 V/2 A max.

EVA-16REL/2

Order No. 0176690

EVA-16 relay board

- For extending switching functions and logic functions available with audio management controller EVA-16/2
- 4 relays, each with 2 floating change-over contacts with 2 connection facilities
- Insertion into microphone bus of the EVA-16 master via 2 x RJ45 plug-in connector available on the card
- Operation via DC voltage (\approx 24 V)
- Multiple relay cards can simultaneously be connected to the microphone bus

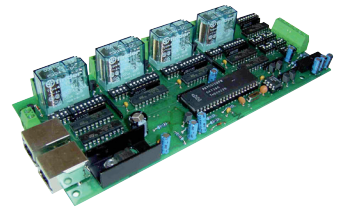

EVA-16IO

Order No. 0174210



Connection PCB according to EN 54-16

- For connecting system microphone station EVA-16TER/2, for example, to the audio management controller EVA-16/2
- The PCB is to be connected to the EVA-16 system via a 25-pole D-sub cable and a Cat. cable, both available at option
- Additionally, it features a changeover contact which is activated in case a fault occurs
- A further relay is activated in case of an emergency and during installation
- It is also used to connect emergency priority relays of L-pad attenuators

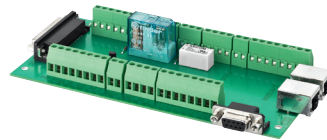

VEN-625/24V

Order No. 1000164

Ventilation kit, for PA equipment rack RACK-625/42.

- Consisting of 2 fans (24 V/18 W) and a thermostat with changeover contact (adjustable 0-60)
- Electronically commutated DC motor with double ball bearings
- Installation via fan plate with 2 cover plates



RACK-625/42

Order No. 0170160



PA equipment rack for 482 mm (19") devices, 42 RU

- For installation of voice alarm systems according to EN 54-16
- Bars adjustable in height in steps of 25 mm for using quick-mount cage nuts
- Flange plate, rear side flange opening in the integrated base with connection jacks for wall distribution
- Ventilation slots in the upper part
- Earthing bolt in each individual part of the case
- Earthing accessories
- Rear-ventilated sheet steel door (rear side of the rack) with cylinder lock
- Colour of body: black, height-adjustable bars: red
- Dimensions: 2,066 x 600 x 600 mm
- Weight: 95 kg

Supplied w/o devices.



RACK-625/42ST

Order No. 0170170



Ventilated sheet steel door, for 19" PA equipment rack RACK-625/42.

- For the front side of the rack
- Cylinder lock
- Colour: black
- Dimensions: 1,745 x 515 mm
- Weight: 15 kg

Supplied w/o 19" PA equipment rack.



Voice Alarm Systems

EN 54 Systems

EPS-24HP

Order No. 1000056



Microprocessor-controlled charging controller

for voice evacuation systems, for setting up a standardised emergency power supply according to EN 54-4.

- Suitable for PA components with 24 V connection
- Output voltage: = 24 V
- Output current: 2 x 60 A max., 4 x 40 A max., 4 x 5 A max., 200 A max. in total
- Charging current: 4-16 A
- Constant monitoring of all primary and secondary input voltages
- Permanent monitoring of the fuses
- Monitoring of the battery charging current
- Indication for discharge status of rechargeable batteries
- LED indication for every relevant operating status
- Floating contacts for retransmission of errors
- Admissible battery capacities: 270 Ah max. (2 x = 12 V each)

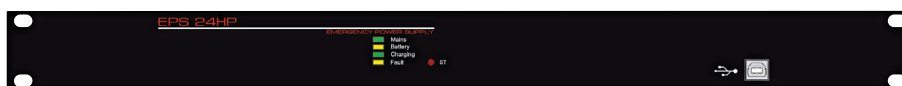

- Cable set EPS-CON for connecting 2 x AKKU-12/120 is available at option
- Power supply: ~ 230 V/50-60 Hz
- Dimensions: 483 x 43 x 330 mm (1 RU)
- Weight: 4.9 kg

Matching rechargeable lead batteries AKKU-12/120 (2 x) are available at option.

EPS-CON

Order No. 1000786



Cable set, for connecting 2 rech. lead batteries AKKU-12/120 to charging controller EPS-24HP.

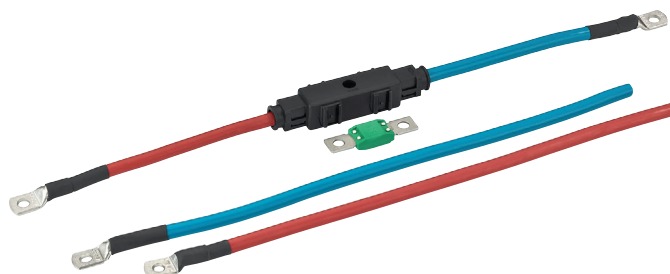

AKKU-12/120

Order No. 0174180

Rechargeable lead battery, 12 V, for charging controller EPS-24HP.

- Power rating: 12 V/120 Ah
- Gas-tight sealed, maintenance-free
- Dimensions: 32.5 x 17 x 22 cm
- Weight: 35 kg
- 2 rech. batteries AKKU-12/120 are required for an operation with EPS-24HP



GD-04K

Order No. 0047680



GSM dialling and control unit

The dialling unit features 4 alarm inputs for activating SMS messages and/or for calling up to 100 authorised telephone numbers. Additionally, 2 relay outputs can be controlled via SMS (additional costs may occur, depending on contract and provider) or free telephone calls from up to 100 authorised telephone numbers.

- Ideally suited as an amok alarm at schools
- 4 alarm inputs
- 2 relay outputs (~ 230 V/2.5 A max.)
- Power (= 10.5-15 V/200 mA max.) is provided via enclosed plug-in power supply
- Programming via USB port with a PC/laptop (free GD-Link software available) or SMS commands
- Smart Home Ready



MEVAC-4

Order No. 0172670



Evacuation controller, with EN 54-16 certification

for voice alarm systems (VAS) according to DIN EN 60849 (VDE 0828) and DIN VDE 0833-4.

As a central controller, the MEVAC-4 can carry out numerous functions:

- Monitoring of the speaker lines
- Monitoring of the amplifiers with emergency switching (for 4 amplifiers and 1 spare amplifier)
- Digital voice storage for alarm announcements
- Monitoring of the fireman's microphones
- Distributor for audio input signals like microphone and background music
- 4 independently addressable announcement circuits in A/B wiring
- Fault signalling via relay contacts

Additional features:

- Connection for any number of emergency announcement microphones (1 ch. or 4 ch.)
- Extensive inputs and outputs for monitoring and signalling



- Modern DSP technology, updatable
- Easy programming via push-buttons and built-in display
- Input for background music
- Aux input to be activated via external contact
- Tone control and volume control for each amplifier channel
- Background music is turned off automatically during 24 V operation
- Bass attenuation in case of an alarm
- RS-232 connection for programming and updating
- Power supply: ~ 230 V/50 Hz/20 VA or = 24 V/500 mA
- Dimensions: 482 x 44 x 315 mm (1 RU)
- Weight: 5 kg
- Mains operation and 24 V emergency power operation

MEVAC-4PTT

Order No. 0235600

PA desktop microphone (push-to-talk), for connection to evacuation controller MEVAC-4.

- 4 call zone push-buttons
- Push-button for all-call function
- Ready to call indication via LED
- Gooseneck with dynamic microphone cartridge
- 1.8 m connection cable with 9-pole D-sub plug



MEVAC-1FT

Order No. 0235590

PA desktop microphone, for emergency announcements according to EN 60849.

- For connection to evacuation controller MEVAC-4
- Monitored microphone cartridge and request line
- Push-to-talk button
- Gooseneck with dynamic microphone cartridge
- Red metal housing (fireman's mic.)
- 1.8 m connection cable with 5-pole DIN plug



MEVAC-1FH

Order No. 0235580

Hand-held PA microphone, for emergency announcements according to EN 60849.

- For connection to evacuation controller MEVAC-4
- Monitored microphone cartridge and request line
- Push-to-talk button
- Red plastic housing (fireman's microphone) with dynamic microphone cartridge and steel clip
- 1 m helix connection cable with 5-pole DIN plug



MEVAC-1CON

Order No. 0172750

Connection box, for hand-held PA microphone MEVAC-1FH or PA desktop microphone MEVAC-1FT.

- 5-pole DIN jack
- Flush mounting into standard 60 mm wall sockets
- Surface mounting with supplied surface-mounted housing
- Dimensions: 80 x 80 x 37 mm



MEVAC-2CON

Order No. 0172760

Connection box, for PA desktop microphone (push-to-talk) MEVAC-1PTT or MEVAC-4PTT.

- 9-pole D-sub jack
- Flush mounting into standard 60 mm wall sockets
- Surface mounting with supplied surface-mounted housing
- Dimensions: 80 x 80 x 37 mm





ONE-500

Order No. 1000100



Voice alarm system (500 W), according to EN 54-16 with integrated emergency power supply (EN 54-4).

- 6 x 100 V speaker line audio outputs
- 2 x class D amplifier 500 W at 70 V/100 V
- EN 54-4 certified emergency power supply
- 3 audio inputs
- Up to 8 microphone stations can be connected
- Internal voice memory for storing pre-recorded messages
- LCD
- Designed for wall mounting/rack mounting
- 8+2 monitored fire alarm inputs

- Emergency priority outputs
- 4 x 0 dB AF output
- DSP equalizer
- Speaker line monitoring
- Fault detection and fault indication

A rechargeable lead battery 12 V/17 Ah is required for emergency power supply. Please order matching rechargeable back-up battery NPA-12/17 separately.

Model	ONE-500
Power supply	~100-240 V/50/60 Hz/350 W max.
Admiss. ambient temp.	-5 °C to +45 °C
Dimensions	453 x 88 x 455 mm
Weight	9,15 kg
Connections	Euroblock
Other features	frequency range: 80-20,000 Hz, S/N ratio: -95 dB(A), THD: < 0.1%

A-1

Order No. 1000097

System microphone station (desktop microphone), 1 zone

- Dynamic microphone cartridge
- Local power supply
- Volume control
- Contact relay can be configured for special applications
- Indication for 'busy', 'ready for operation' and 'ready to call'
- Gooseneck with LED indication
- Suitable for voice alarm system ONE-...



MPS-8Z

Order No. 1000101



System microphone station (desktop microphone), 8 zones

- Programmable buttons for 8 zones
- Programmable activities
- Callback function
- Automatic lock function
- LED indication for zone selection
- LED indication for status of voice alarm system ONE-...
- LED indication for 'busy' and general status of microphone station

- Long-life high-performance microphone cartridge
- Approved according to EN 54-16
- Suitable for voice alarm system ONE-...



MPS-8K

Order No. 1000098



Extension unit, for system microphone station (desktop microphone) MPS-8Z.

- 8 buttons for zone selection
- High-quality workmanship and robust housing for continuous operation
- Steel version, anthracite-grey (RAL 7016)
- EN 54 certification



ONE-BC1

Order No. 1000099

Activation card

- For activating emergency power supply with EN 54 certification
- Micro SD card for permanent installation into voice alarm system ONE-500

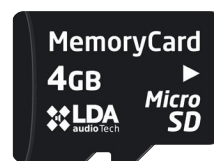

ONE-RMA

Order No. 1000109

Mounting set, 3 RU, including mounting screws. For mounting voice alarm system ONE-500.



ONE-RMA2

Order No. 1000111

482 mm (19") rack mounting bracket

- For mounting voice alarm system ONE-500 into a 482 mm (19") rack
- 2 RU
- Supplied with mounting screws

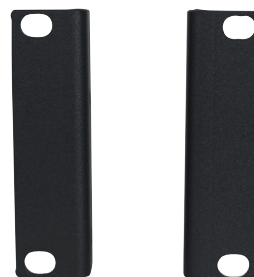

ONE-WMA

Order No. 1000107

Wall bracket

- For wall mounting voice alarm system ONE-500
- Galvanised metal
- 4 mounting holes, Ø 6.5 mm
- Supplied with mounting screws

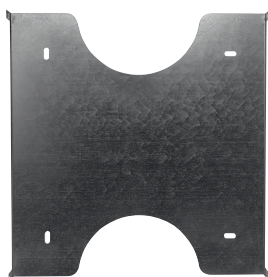

TFL-2

Order No. 1000116

Sounder circuit end of line resistor module (EOL)

- Monitoring of 70 V or 100 V speaker cables
- Easy connection
- Easy installation
- Multiple units can be connected to the same speaker cable
- Low power consumption
- Suitable for voice alarm systems NEO-... and ONE-...



STE-21

Order No. 1000115

I/O Ethernet interface module, for controlling and monitoring devices without Ethernet connection.

- Ethernet: 10/100 Base-T, full-duplex and half-duplex (auto)
- Supported protocols: TCP, UDP, HTTP, Telnet

- Connections:
 - 1 x Ethernet port
 - 2 x RS-232 port
 - 1 x RS-485 port
 - 2 x IR port
 - 10 x GPIO port
 - 1 x USB port

Voice Alarm Systems System Components

VAP-1

Order No. 1000117



Emergency microphone station (EN 54-16)

- Up to 56 groups with up to 8 sections per group (448 sections in the whole system)
- Pre-alarm event launcher
- Attention signal
- Volume control
- Indications for power supply, emergency status, fault status, connection with system, power supply fault, microphone cartridge fault
- Transmission of voice evacuation messages and display of pre-recorded messages
- Emergency controls, reset, confirm, test, alarm signal, evacuation signal
- Lateral connection (connect port) of up to 7 extension keypads VAP-8K
- Priority configuration and operating parameters
- Local power supply or power supply via central unit
- Wall mounting or 482 mm (19") rack mounting
- EN 54 certification



Model	VAP-1
Power supply	≐ 4.5-5.5 V/200-500 mA
Admiss. ambient temp.	-5 °C to +45 °C
Dimensions	259 x 132 x 50 mm
Weight	2.12 kg
Connections	2 x RJ45 (ASCII bus in/out) mini USB (power supply)

VAP-8K

Order No. 1000119



Extension keypad

- 8 additional buttons for emergency microphone station VAP-1
- Up to 7 x VAP-8K can be connected to a VAP-1
- LED indications
- Robust metal housing
- EN 54 certification



VAP-1EC

Order No. 1000118

Mounting kit, for mounting emergency system microphone station VAP-1 into wall-mounted housings RACK-4ALT and RACK-6ALT.



RACK-6ALT

Order No. 1000102

482 mm (19") wall-mounted housing, 6 RU

- Rack for wall mounting, 6 RU
- Metal framed glass door at the front with lock and key, opening angle: 180°
- Complete design with 19" rack guides
- Wiring opening at the top and bottom
- Dimensions: 601 x 372 x 152 mm



PA-26FMU

Order No. 0175040



PA emergency sound system, for integrating into PA systems according to EN 60849.

- Hand-held microphone with monitored functionality
- Alarm input for triggering alarm
- Reproduction of MP3 voice recordings via integrated SD card slot (for media up to 32 GB, not supplied), volume control
- Siren emits an acoustic signal for 10 seconds when alarm is triggered, volume control
- Built-in signal light FIRE flashes when alarm is triggered
- Balanced line output via screw terminal
- 24 V power supply via PSS-3000SV, available at option



Model	PA-26FMU
Output level	1.23 V/600 Ω, bal.
Siren frequency	800 Hz
Max. recording time	dep. on storage medium
Power supply	= 24 V/200 mA
Dimensions	482 x 88 x 200 mm, 2 RU
Weight	3 kg

PA-24ESP

Order No. 0243120



24 V emergency power supply, for our PA components with 24 V connection.

- Possible to install 2 x rechargeable lead battery NPA-12/24
- Screw terminals for external 24 V rechargeable batteries
- Maximum charging current: 2.5 A
- Electronic charging control with overload protection, protection against total discharge and trickle charge
- 1 x output = 24 V/1 A (unswitched)
- 2 x output = 24 V/32 A
- 3 x output = 24 V/16 A
- Power supply: ~ 230 V/50 Hz/110 VA
- Dimensions: 482 x 135 x 405 mm
- Weight: 11.7 kg



MAESTRO-1

Order No. 0176250



PA telephone announcement adapter, for connecting to a telephone system as an analogue AB extension line.

- Announcement facility for each telephone connected to the telephone system
- Automatic call acceptance
- Automatic disconnection
- Chime can be activated as required
- Integrated micro SD card (4 GB) for storing announcements (audio files in MP3 format or WAV format)
- Analogue telephone connection (2-wire connection)
- Connection via plug-in screw terminals
- Mini USB port for configuration of the MAESTRO-1 via PC or laptop
- Power is provided via enclosed plug-in power supply
- Supplied with USB cable



Voice Alarm Systems

EN 54 Speakers

EDL-530EN/SW

Order No. 1000261



EDL-530EN/WS

Order No. 1000262



High-quality PA pendant speakers, with EN 54-24 certification.

- 100 V transmission technology or 8 Ω operation
- 2-way coaxial system (5.25")
- UV-resistant ABS housing with aluminium grille
- Excellent sound quality for speech and music
- 5 m safety rope
- Plug-in screw terminal

Model	EDL-530EN/SW, EDL-530EN/WS
Power rating (RMS)	30/15/7.5/3.8 W
Impedance	8 Ω
Frequency range	65-20,000 Hz
SPL	90 dB/W/m
Housing material	ABS
Dimensions	Ø 195 mm x 250 mm
Weight	2.26 kg
Inputs	plug-in screw terminal



EDL-416EN/WS

Order No. 0163420



Moisture-proof PA ball speaker, with EN 54-24 certification, 1438-CPR-0535.

- 100 V transmission technology
- White ABS housing (UL 94HB), UV-resistant and weatherproof
- Moisture-proof speaker cone
- Supplied with 450 cm connection cable and canopy
- Ceramic connection terminal, thermal fuse

Model	EDL-416EN/WS
Power rating (RMS)	16/8/4 W
Frequency range	130-18,000 Hz
SPL	89.9 dB/W/m
Beam angle	196° (1 kHz) 132° (2 kHz) 170° (4 kHz)
Protection class	IP35
Admiss. ambient temp.	-20 °C to +80 °C
Dimensions	Ø 185 mm x 157 mm
Weight	1.6 kg



ESP-1000AB

Order No. 0163670



PA A/B wall speaker, with EN 54-24 certification for voice evacuation systems with A/B speaker distribution according to EN 60849.

- 100 V transmission technology
- 2 x 10 cm full range speaker
- 2 separate transformers with power taps with 6/3/1.5 W each
- Connection via 2 ceramic screw terminals inside the cabinet
- Plastic cabinet with open rear panel with protective metal front grille
- Supplied with aluminium mounting bracket, screws and wall plugs

Model	ESP-1000AB
Power rating (RMS)	2 x 6/3/1.5 W
Frequency range	80-20,000 Hz
SPL	92 dB/W/m
Beam angle	160°
Admiss. ambient temp.	-10 °C to +50 °C
Dimensions	Ø 220 mm x 100 mm
Weight	1.98 kg



ESP-62AB/WS

Order No. 0163660



PA A/B wall speaker, with EN 54-24 certification for voice evacuation systems with A/B speaker distribution according to EN 60849.

- 100 V transmission technology
- 13 cm full range speaker with dual voice coil
- 2 separate transformers with power taps with 6/3/1.5 W each
- Connection via 2 ceramic screw terminals inside the cabinet
- Symmetrical design allows for horizontal and vertical mounting

Model	ESP-62AB/WS
Power rating (RMS)	2 x 6/3/1.5 W
Frequency range	80-19,000 Hz
SPL	93 dB/W/m
Beam angle	160°
Admiss. ambient temp.	-10 °C to +50 °C
Dimensions	240 x 330 x 83 mm
Weight	1.5 kg

- Plastic cabinet with open rear panel and protective metal front grille
- Supplied with screws and wall plugs

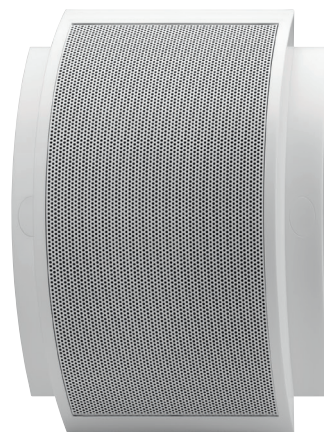

ESP-62/WS

Order No. 0163030



PA wall speaker, with EN 54-24 certification.

- 100 V transmission technology via audio transformer with 3 power taps
- Full range speaker with a high-quality sound and a clear voice reproduction
- Plastic cabinet of a special design (open rear panel) with protective metal grille
- Symmetrical design allows for horizontal and vertical mounting
- Supplied with mounting screws and screw head covers
- Ball-proof according to DIN 18032, Part 3

Model	ESP-62/WS
Power rating (RMS)	6/3/1.5 W
Frequency range	100-19,000 Hz
SPL	93 dB/W/m
Admiss. ambient temp.	-10 °C to +50 °C
Dimensions	240 x 330 x 85 mm
Weight	1.2 kg



ESP-50AB/WS

Order No. 0160120



PA A/B wall speaker, with EN 54-24 certification for voice evacuation systems with A/B speaker distribution according to EN 60849 and DIN VDE 0833-4.

- 100 V transmission technology
- 2 separate full range speakers (10 cm), each with its own transformer 6/3/1.5 W
- Connection via 2 spring-loaded terminals inside the cabinet
- Wooden cabinet with protective metal grille
- Easy wall mounting via supplied metal bracket and mounting accessories

Model	ESP-50AB/WS
Power rating (RMS)	2 x 6/3/1.5 W
Frequency range	120-20,000 Hz
SPL	92 dB/W/m
Admiss. ambient temp.	-10 °C to +50 °C
Dimensions	265 x 165 x 90 mm
Weight	1.9 kg

- Ball-proof according to DIN 18032, Part 3

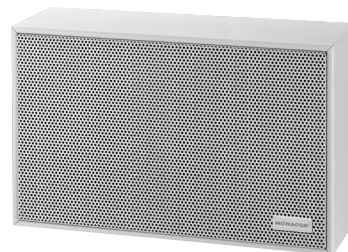

ESP-50EN/WS

Order No. 0160260



PA wall speaker, with EN 54-24 certification.

- 100 V transmission technology
- Full range speaker (13 cm)
- Suitable for voice and music transmissions
- Connection via spring-loaded terminal inside the cabinet
- Wooden cabinet with protective metal grille
- Easy wall mounting via supplied mounting bracket and mounting accessories
- Ball-proof according to DIN 18032, Part 3

Model	ESP-50EN/WS
Power rating (RMS)	6/3/1.5 W
Frequency range	100-19,000 Hz
SPL	93 dB/W/m
Housing material	wood
Admiss. ambient temp.	-10 °C to +50 °C
Dimensions	265 x 165 x 90 mm
Weight	1.6 kg



Voice Alarm Systems

EN 54 Speakers

EDL-250C/WS

Order No. 0160110



PA ceiling speaker, with EN 54-24 certification.

- 100 V transmission technology
- Full range speaker with a very high efficiency and high maximum volume level
- Metal housing
- Fire protection cover
- Quick mounting facility
- 3 power taps via push terminals
- Ball-proof according to DIN 18032, Part 3

Model	EDL-250C/WS
Frequency range	70-19,000 Hz
Peak music power output (MAX)	6/3/1.5 W
SPL	98 dB/W/m
Mounting cutout	Ø 230 mm
Dimensions	Ø 252 mm x 110 mm
Colour	white
Weight	1.8 kg



EDL-224ABC

Order No. 0160100



PA A/B ceiling speaker, with EN 54-24 certification.

For systems with A/B speaker distribution. Cost-effective reduction of the required ceiling cutouts.

- 100 V transmission technology
- 2 separate speaker systems
- Full range speaker with a very high efficiency and high maximum volume level
- Metal housing
- Fire protection cover

Model	EDL-224ABC
Frequency range	75-20,000 Hz
Power rating (RMS)	2 x 6/2 x 3/2 x 1.5 W
SPL	92 dB/W/m
Mounting cutout	Ø 230 mm
Dimensions	Ø 252 mm x 115 mm
Colour	white
Weight	1.84 kg

- Quick mounting facility



EDL-165AB/WS

Order No. 0163650



PA A/B ceiling speaker, with EN 54-24 certification for systems with A/B speaker distribution according to EN 60849.

- 100 V transmission technology
- 13 cm full range speaker with dual voice coil
- 2 separate transformers with power taps with 6/3/1.5 W each
- Connection via 2 ceramic screw terminals inside the cabinet

Model	EDL-165AB/WS
Frequency range	80-19,000 Hz
Power rating (RMS)	2 x 6/3/1.5 W
SPL	93 dB/W/m
Max. rated SPL	101 dB
Radiation angle	180°
Mounting cutout	Ø 140-150 mm
Dimensions	Ø 170 mm x 95 mm
Colour	white, RAL 9010
Weight	1.4 kg



EDL-165C/WS

Order No. 0160090



PA ceiling speaker, with EN 54-24 certification.

- 100 V transmission technology
- Full range speaker with a high efficiency
- Metal housing
- Fire protection cover
- Quick mounting facility
- 3 power taps via push terminals
- Ball-proof according to DIN 18032, Part 3

Model	EDL-165C/WS
Frequency range	80-19,000 Hz
Power rating (RMS)	6/3/1.5 W
SPL	93 dB/W/m
Mounting cutout	Ø 150 mm
Dimensions	Ø 170 mm x 95 mm
Colour	white
Weight	1.1 kg



IT-350/EN

Order No. 0163950



Weatherproof horn speaker (music horn), 2-way technology and EN 54-24 certification

- 100 V transmission technology with 4 power taps: 30/15/7.5/3.75 W
- Weatherproof and IP66 certified
- High-quality music reproduction
- 16 cm bass-midrange speaker and 25 mm (1") horn
- Robust light grey ABS plastic housing
- Supplied with mounting bracket and stainless steel screws

Model	IT-350/EN
Power rating (RMS)	30/15/7.5/3.75 W
Frequency range	100-20,000 Hz
SPL	101 dB/W/m
Beam angle	H: 100°/V: 60°
Features	2-way
Protection class	IP66
Admiss. ambient temp.	-20 °C to +90 °C
Dimensions	370 x 250 x 330 mm
Weight	4.5 kg

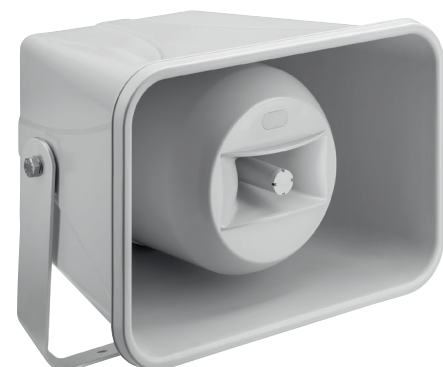

IT-32EN

Order No. 0160020



IT-15EN

Order No. 0160230



Weatherproof horn speakers, with EN 54-24 certification.

- 100 V transmission technology
- IP66 tested
- Light grey ABS housing (self-extinguishing, complies with the standard UL 94V-0)
- Cable inlet via high-strength cable gland

Model	IT-32EN	IT-15EN
Power rating (RMS)	30/15/7.5 W	15/7.5/3.75 W
Frequency range	350-10,000 Hz	350-10,000 Hz
SPL	110 dB/W/m	110 dB/W/m
Beam angle	H: 110°/V: 55°	H: 110°/V: 55°
Admiss. ambient temp.	-25 °C to +70 °C	-25 °C to +70 °C
Dimensions	180 x 120 x 230 mm	180 x 120 x 230 mm
Weight	2.1 kg	2.1 kg



RL-1ENABDS

Order No. 0163690



PA A/B sound projector for wall mounting, with EN 54-24 certification for voice evacuation systems with A/B speaker distribution according to EN 60849.

- 100 V transmission technology
- 13 cm full range speaker with dual voice coil
- 2 x 100 V transformer with power taps on the cable 6/3/1.5 W
- Connection via 2 x 4-core cable (length: 1.5 m)
- Metal housing with front protective grille

Model	RL-1ENABDS
Power rating (RMS)	2 x 6/3/1.5 W
Frequency range	80-20,000 Hz
SPL	93 dB/W/m
Beam angle	130°
Dimensions	Ø 144 mm x 210 mm
Weight	2.3 kg

- Supplied with pan/tilt bracket and mounting accessories



RL-1EN

Order No. 0163680



PA sound projector for wall mounting, with EN 54-24 certification.

- 100 V transmission technology
- 13 cm full range speaker
- 100 V transformer with power taps on the cable 6/3/1.5 W
- Connection via 4-core cable (length: 1.5 m)
- Metal housing with front protective grille

Model	RL-1EN
Power rating (RMS)	6/3/1.5 W
Frequency range	80-20,000 Hz
SPL	93 dB/W/m
Beam angle	130°
Dimensions	Ø 144 mm x 210 mm
Weight	1.9 kg

- Supplied with pan/tilt bracket and mounting accessories



DA-P20-130/T

Order No. 0163880



Weatherproof PA sound projector, for wall mounting and with EN 54-24 certification.

- 100 V transmission technology
- 13 cm waterproof full range speaker
- 100 V transformer with power taps on the cable 20/10/5/2.5 W
- Connection via ceramic terminal and thermal fuse in the junction box (cable length: 1 m)
- ABS plastic housing with front protective grille

Model	DA-P20-130/T
Power rating (RMS)	20/10/5/2.5 W
Frequency range	150-20,000 Hz
SPL	90 dB/W/m
Beam angle	110°
Admiss. ambient temp.	-20 °C to +90 °C
Dimensions	Ø 145 mm x 222 mm
Weight	1.367 kg

- Robust aluminium mounting bracket



DA-10-260/T

Order No. 0163710



Weatherproof PA sound projector, for wall mounting and with EN 54-24 certification.

- 100 V transmission technology
- 2 x 13 cm full range speaker for bi-directional radiation
- 100 V transformer with power taps 10/6/3/1.5 W
- Connection via ceramic terminals with thermal fuse in the mounting base

Model	DA-10-260/T
Power rating (RMS)	10/6/3/1.5 W
Frequency range	120-17,000 Hz
SPL	93 dB/W/m
Beam angle	150°
Protection class	IP65
Admiss. ambient temp.	-20 °C to +90 °C
Dimensions	166 x 197 x 161 mm
Weight	2.31 kg

- Robust plastic-coated aluminium housing with front protective grille
- Robust vandal-resistant aluminium mounting base



Speakers

Flush-mount Speakers

EDL-620EN

Order No. 0163180



EDL-612EN

Order No. 0163170



EDL-606EN

Order No. 0163160



PA ceiling speakers, with EN 54-24 certification.

- 100 V transmission technology with 3 power taps
- Full range speaker with optimised voice reproduction
- Plastic cover with low mounting depth
- For a ceiling thickness from 5 to 22 mm
- Quick installation
- Robust metal basket and protective grille



Model	EDL-620EN	EDL-612EN	EDL-606EN
Frequency range	120-15,000 Hz	120-15,000 Hz	120-15,000 Hz
Power rating (RMS)	20/10/5 W	12/6/3 W	6/3/1.5 W
SPL	93 dB/W/m	93 dB/W/m	93 dB/W/m
Mounting cutout	Ø 180 mm	Ø 180 mm	Ø 180 mm
Dimensions	Ø 200 mm x 70 mm	Ø 200 mm x 70 mm	Ø 200 mm x 70 mm
Colour	white	white	white
Weight	1.1 kg	950 g	880 g

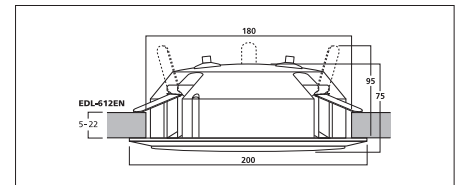

EDL-620

Order No. 0162590



EDL-612

Order No. 0161810



EDL-606

Order No. 0161800



PA ceiling speakers

- 100 V transmission technology via audio transformer with power taps
- For a ceiling thickness from 5 to 22 mm
- Full range speaker, type 165
- A more powerful reproduction of the range of fundamental notes
- Robust metal version (basket and protective grille)



Model	EDL-620	EDL-612	EDL-606
Frequency range	100-20,000 Hz	100-20,000 Hz	100-20,000 Hz
Power rating (RMS)	20/10/5 W	12/6/3 W	6/3/1.5 W
SPL	93 dB/W/m	92 dB/W/m	92 dB/W/m
Mounting cutout	Ø 180 mm	Ø 180 mm	Ø 180 mm
Dimensions	Ø 200 mm x 65 mm	Ø 200 mm x 60 mm	Ø 200 mm x 60 mm
Colour	white	white	white
Weight	900 g	750 g	698 g

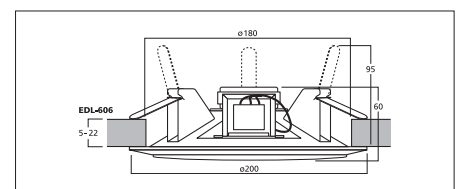

EDL-706/12

Order No. 0163370



PA ceiling speaker

- 100 V transmission technology via audio transformer with power taps
- For a ceiling thickness from 5 to 22 mm
- Full range speaker, type 165
- Good speech intelligibility
- Robust metal version (basket and protective grille)

Supplied in packing units (PU) of 12 pcs. only



Model	EDL-706/12
Frequency range	120-17,000 Hz
Power rating (RMS)	6/3/1.5 W
SPL	93 dB/W/m
Mounting cutout	Ø 170 mm
Dimensions	Ø 200 mm x 65 mm
Colour	white
Weight	0.6 kg

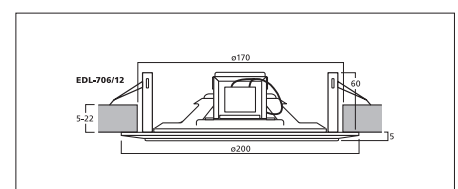

EDL-118TW

Order No. 0163850

100V

EDL-116TW

Order No. 0163840

100V

PA ceiling speakers, with integrated tweeter.

- 100 V transmission technology
- 2-way coaxial speaker
- Metal housing with protective grille
- Quick-mounting facility with spring clips
- Connection via spring-loaded terminal
- For a ceiling thickness from 10 to 40 mm

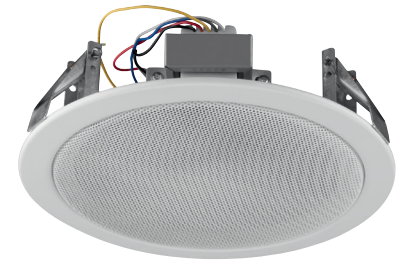

Model	EDL-118TW	EDL-116TW
Frequency range	90-20,000 Hz	90-20,000 Hz
Power rating (RMS)	15/10/6/3 W	10/6/3/1.5 W
SPL	94 dB/W/m	92 dB/W/m
Max. rated SPL	106 dB	102 dB
Mounting cutout	Ø 216 mm	Ø 166 mm
Dimensions	Ø 252 mm x 85 mm	Ø 195 mm x 55 mm
Colour	white	white
Weight	1.21 kg	0.82 kg

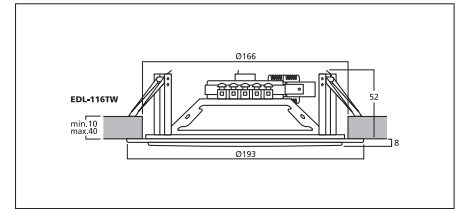

EDL-18

Order No. 0163830

100V

EDL-16

Order No. 0163820

100V

EDL-15

Order No. 0163810

100V

PA ceiling speakers

- 100 V transmission technology
- EDL-18: 20 cm (8") full range speaker
- EDL-16: 15 cm (6") full range speaker
- EDL-15: 13 cm (5") full range speaker
- Metal housing with protective grille
- Quick-mounting facility with spring clips
- Connection via spring-loaded terminal
- For a ceiling thickness from 10 to 40 mm

Model	EDL-18	EDL-16	EDL-15
Frequency range	90-16,000 Hz	90-16,000 Hz	100-16,000 Hz
Power rating (RMS)	10/6/3/1.5 W	10/6/3/1.5 W	6/3/1.5 W
SPL	94 dB/W/m	92 dB/W/m	92 dB/W/m
Max. rated SPL	106 dB	102 dB	100 dB
Mounting cutout	Ø 216 mm	Ø 166 mm	Ø 152 mm
Dimensions	Ø 252 mm x 85 mm	Ø 195 mm x 55 mm	Ø 182 mm x 50 mm
Colour	white	white	white
Weight	1.18 kg	0.8 kg	0.6 kg

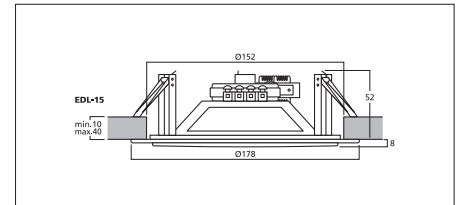

EDL-28

Order No. 0161460

100V

EDL-26

Order No. 0161450

100V

EDL-25

Order No. 0161440

100V

EDL-24

Order No. 0161430

100V

PA ceiling speakers

- 100 V transmission technology via audio transformer with power taps
- Full range speaker with dual cone
- Plastic housing with protective metal grille
- ABS plastic material, self-extinguishing according to UL 94V-0
- For a ceiling thickness from 10 to 40 mm

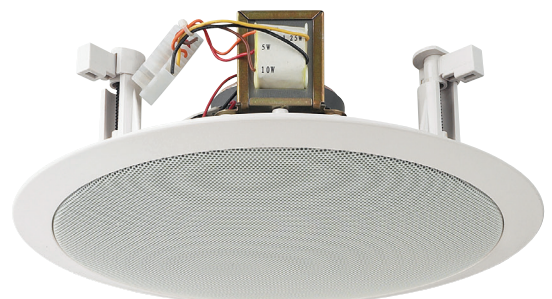

Model	EDL-28	EDL-26	EDL-25	EDL-24
Frequency range	60-14,000 Hz	80-14,000 Hz	100-14,000 Hz	100-14,000 Hz
Power rating (RMS)	10/5/2.5/1.25 W	10/5/2.5/1.25 W	6/3/1.5 W	6/3/1.5 W
SPL	91 dB/W/m	86 dB/W/m	87 dB/W/m	87 dB/W/m
Max. rated SPL	100 dB	95 dB	94 dB	94 dB
Mounting cutout	Ø 240 mm	Ø 200 mm	Ø 165 mm	Ø 142 mm
Dimensions	Ø 275 mm x 90 mm	Ø 230 mm x 85 mm	Ø 205 mm x 70 mm	Ø 170 mm x 70 mm
Colour	white	white	white	white
Weight	1.14 kg	0.922 kg	0.724 kg	0.63 kg

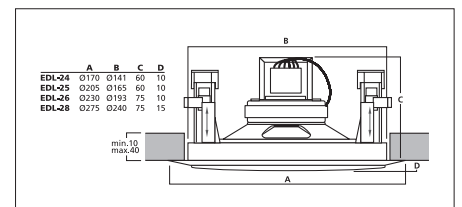

Speakers

Flush-mount Speakers

EDL-6

Order No. 1000263



PA ceiling speaker

- 100 V transmission technology
- 15 cm (6") full range speaker
- Plastic housing with metal grille
- Power taps: 8 W
- Quick-mounting facility with spring clips
- Connection via screw terminal
- For a ceiling thickness from 5 to 25 mm

Model	EDL-6
Frequency range	90-18,000 Hz
Power rating (RMS)	8 W
SPL	90 dB/W/m
Max. rated SPL	99 dB
Radiation angle	H: 90°/V: 90°
Voice coil diameter	Ø 20 mm
Mounting cutout	Ø 170 mm
Dimensions	Ø 193 mm x 72 mm
Colour	white
Weight	476 g

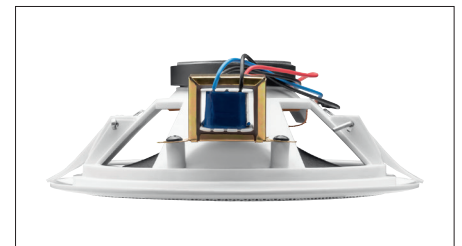
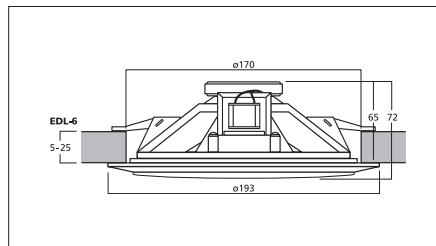

EDL-36TW

Order No. 0162070



PA ceiling speaker

- 100 V transmission technology
- Additional integrated tweeter
- Fire protection cover
- Metal housing with fitted ceramic terminal
- Thermal fuse: 1 A/150 °C
- 3-step power selector switch
- Glass fibre insulated supply line with high-strength cable gland
- Quick-mounting facility
- For a ceiling thickness from 2 to 40 mm

Model	EDL-36TW
Frequency range	150-20,000 Hz
Power rating (RMS)	10/5/2.5 W
SPL	95 dB/W/m
Mounting cutout	Ø 190 mm
Dimensions	Ø 200 mm x 100 mm
Colour	white
Weight	1.45 kg

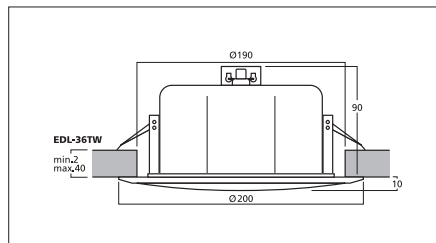

**Professional
PA solutions
for your project**



MONACOR

Your Project is Our Project

www.monacor.com/audio-solution-guide

EDL-70/WS

Order No. 0163310



PA ceiling speaker, with special 2-step mounting.

- 100 V transmission technology
- Snap-in mounting
- For a ceiling thickness from 2 to 45 mm
- Full range speaker with a clear voice reproduction
- Wide frequency range
- Robust metal version (basket and protective grille)

Model	EDL-70/WS
Frequency range	90-20,000 Hz
Power rating (RMS)	6/3/1,5 W
SPL	97 dB/W/m
Mounting cutout	Ø 195 mm
Dimensions	Ø 220 mm x 104 mm
Colour	white, RAL 9010
Weight	1 kg

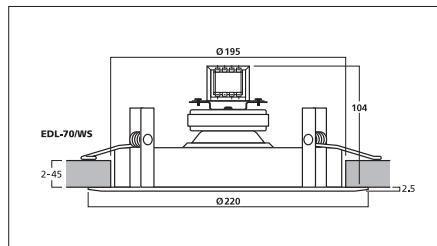

EDL-11TW

Order No. 0161210



PA ceiling speaker

- 100 V transmission technology
- White metal housing
- Including fire protection cover for a high safety level
- Additional integrated tweeter
- Quick-mounting facility
- For a ceiling thickness from 3 to 20 mm

Model	EDL-11TW
Frequency range	60-20,000 Hz
Power rating (RMS)	10/5/2.5 W
SPL	97 dB/W/m
Mounting cutout	Ø 225 mm
Dimensions	Ø 264 mm x 120 mm
Colour	white
Weight	1.73 kg

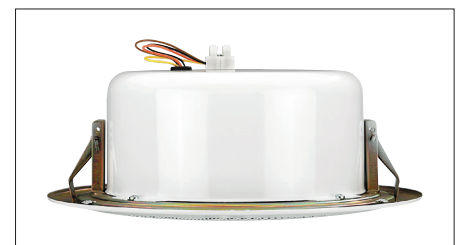
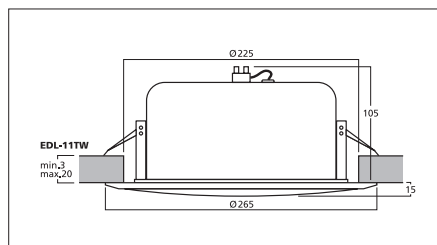

EDL-11TW/SW

Order No. 0162410



PA ceiling speakers

- 100 V transmission technology
- Black metal housing
- Including fire protection cover for a high safety level
- Additional integrated tweeter
- Quick-mounting facility
- For a ceiling thickness from 3 to 20 mm

Model	EDL-11TW/SW
Frequency range	60-20,000 Hz
Power rating (RMS)	10/5/2.5 W
SPL	97 dB/W/m
Mounting cutout	Ø 225 mm
Dimensions	Ø 264 mm x 120 mm
Colour	black
Weight	1.6 kg

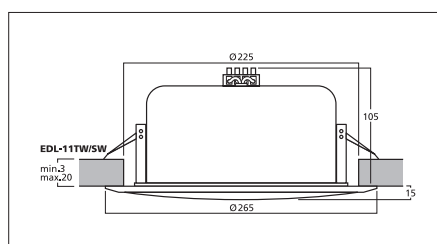

Speakers

Flush-mount Speakers

EDL-206

Order No. 0161650



EDL-204

Order No. 0161630



Weatherproof flush-mount PA speakers

- 100 V transmission technology
- Full range speaker with dual cone, perfect sound characteristics
- Splashproof due to white one-piece plastic design, high-quality polypropylene cone with rubber surround
- For indoor and outdoor applications
- Supplied with stainless steel mounting screws

Model	EDL-206	EDL-204
Frequency range	85-18,000 Hz	100-18,000 Hz
Power rating (RMS)	20/15/10/5/2.5 W	20/15/10/5/2.5 W
SPL	90 dB/W/m	89 dB/W/m
Mounting cutout	Ø 132 mm	Ø 104 mm
Dimensions	Ø 180 mm x 130 mm	Ø 132 mm x 118 mm
Colour	white	white
Weight	900 g	812 g

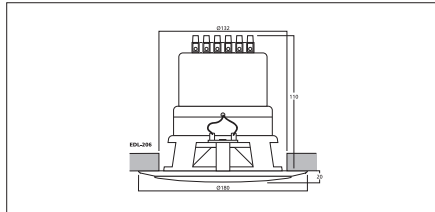

EDL-82/WS

Order No. 0161490



PA ceiling speaker

- 100 V transmission technology
- White cover
- Similar design to standard flush-mounted halogen lights
- Suitable for speech and background music, very consistent frequency response
- Quick-mounting facility
- Plastic housing with protective metal grille
- ABS plastic material, self-extinguishing according to UL 94V-0
- For a ceiling thickness from 2 to 14 mm

Model	EDL-82/WS
Frequency range	200-20,000 Hz
Power rating (RMS)	6/3/1.5 W
SPL	86 dB/W/m
Mounting cutout	Ø 96 mm
Dimensions	Ø 100 mm
Colour	white
Weight	635 g

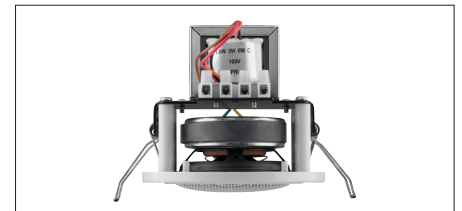
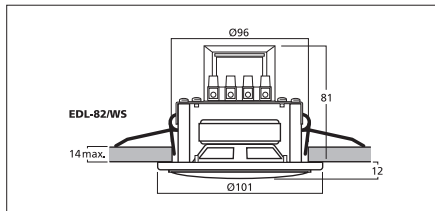

EDL-22/WS

Order No. 0162770



PA ceiling speaker, small and compact design, with a very wide bandwidth reproduction.

- 100 V transmission technology
- Quick-mounting facility
- White plastic housing
- For a ceiling thickness from 2 to 10 mm

Model	EDL-22/WS
Frequency range	130-20,000 Hz
Power rating (RMS)	6/3/1.5 W
SPL	85 dB/W/m
Mounting cutout	Ø 73 mm
Dimensions	Ø 83 mm x 70 mm
Colour	white
Weight	325 g

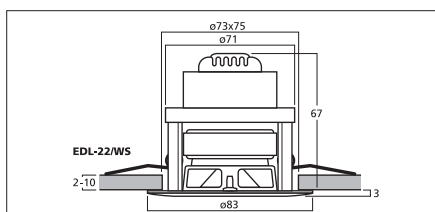



ESUB-6C/WS

Order No. 0259340



Flush-mount wall and ceiling PA subwoofer, 55 W

- Band-pass subwoofer with 16 cm (6") speaker of long excursion
- 100 V transmission technology, with 4 power taps
- Switchable to 4 Ω
- Supplied with UL-certified safety rope as additional mounting safeguard for the subwoofer
- Robust ceramic connecting terminal
- Integrated crossover network
- For a ceiling thickness from 5 to 32 mm

Model	ESUB-6C/WS
Frequency range	45-280 Hz
Power rating (RMS)	40/20/10 W (100 V), 55 W (4 Ω)
Peak music power output (MAX)	110 W
SPL	88 dB/W/m
Max. rated SPL	104 dB
Radiation angle	180°
Mounting cutout	Ø 268 mm
Dimensions	Ø 310 mm x 265 mm
Colour	white
Weight	5 kg

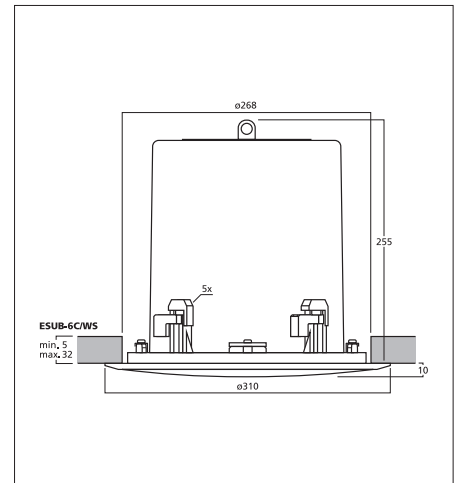
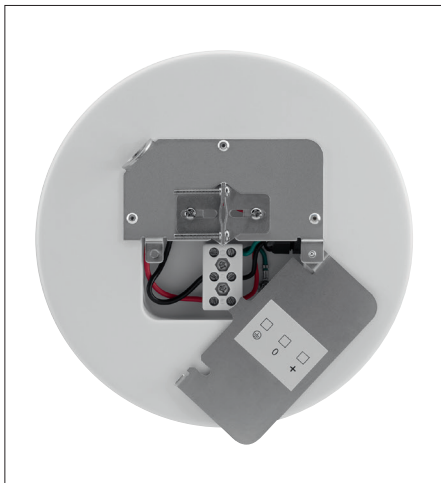

Speakers

Wall and Ceiling Speakers

EDL-82HQ

Order No. 0163440



PA hi-fi wall and ceiling speaker, 30 W

- 100 V transmission technology or 8 Ω operation
- 2-way version with coaxial dome tweeter
- 20 cm (8") bass speaker with waveguide and 25 mm (1") silk dome
- Pivoting tweeter via ball joint
- Excellent sound characteristics
- Stylish flush fit protective metal grille with slim plastic frame
- Protective grille magnetically attached to speaker front
- For a wall thickness/ceiling thickness from 6 to 35 mm

Model	EDL-82HQ
Frequency range	30-20,000 Hz
Resonant frequency (fs)	40 Hz
Power rating (RMS)	50 W (8 Ω) 30/16/8/4 W (100 V)
SPL	89 dB/W/m
Mounting cutout	Ø 252 mm
Dimensions	Ø 295 mm x 100 mm
Colour	white/black
Weight	2 kg

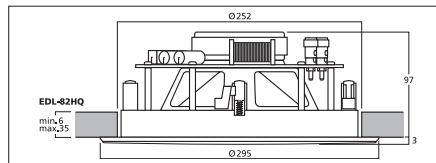

EDL-62HQ

Order No. 0163430



PA hi-fi wall and ceiling speaker, 30 W

- 100 V transmission technology or 8 Ω operation
- 2-way version with coaxial dome tweeter
- 16 cm (6½") bass speaker with waveguide and 25 mm (1") silk dome
- Pivoting tweeter via ball joint
- Excellent sound characteristics
- Stylish flush fit protective metal grille with slim plastic frame
- Protective grille magnetically attached to speaker front
- For a wall thickness/ceiling thickness from 6 to 35 mm

Model	EDL-62HQ
Frequency range	50-20,000 Hz
Resonant frequency (fs)	60 Hz
Power rating (RMS)	35 W (8 Ω) 30/16/8/4 W (100 V)
SPL	89 dB/W/m
Mounting cutout	Ø 210 mm
Dimensions	Ø 250 mm x 98 mm
Colour	white/black
Weight	1.82 kg

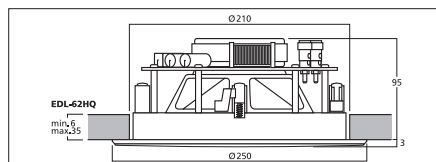

EDL-42HQ

Order No. 0163890



Hi-fi wall and ceiling speaker, 15 W

- 100 V transmission technology or 8 Ω operation
- Power taps: 100 V (8/4/2/1 W)
- 2-way version with coaxial dome tweeter
- 10 cm (4") bass speaker with waveguide and 20 mm (3/4") silk dome
- Excellent sound characteristics
- Supplied with 2 stylish protective metal grilles for an individual look
- Protective grille to be magnetically attached
- For a wall thickness/ceiling thickness from 8 to 30 mm

Model	EDL-42HQ
Frequency range	70-20,000 Hz
Resonant frequency (fs)	70 Hz
Power rating (RMS)	15 W (8 Ω) 8/4/2/1 W (100 V)
Peak music power output (MAX)	30 W
SPL	85 dB/W/m
Max. rated SPL	96 dB
Mounting cutout	Ø 141 mm
Dimensions	Ø 158 mm x 72 mm
Colour	white
Weight	0.930 kg

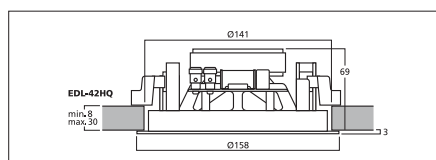
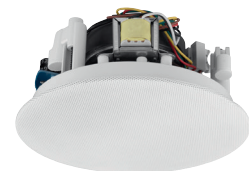

EDL-158

Order No. 0162930



EDL-156

Order No. 0161910



EDL-155

Order No. 0162920



Weatherproof PA ceiling speakers, heat-resistant up to 100 °C. For applications in saunas and swimming pool areas.

- 100 V transmission technology
- 2-way system with dome tweeter
- Excellent sound
- White plastic housing
- Weatherproof speaker cone
- Tested according to ASTM B117 (400 h salt spray test)
- For a ceiling thickness from 2 to 25 mm

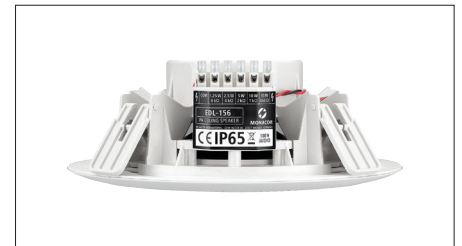
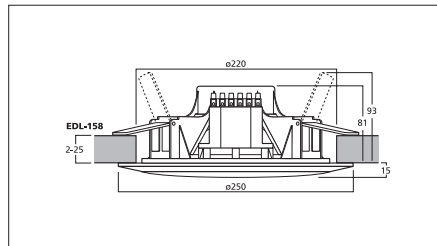

Model	EDL-158	EDL-156	EDL-155
Frequency range	50-16,000 Hz	60-20,000 Hz	70-18,000 Hz
Power rating (RMS)	15/10/5/2.5/1.25 W	15/10/5/2.5/1.25 W	15/10/5/2.5/1.25 W
SPL	89 dB/W/m	88 dB/W/m	87 dB/W/m
Mounting cutout	Ø 220 mm	Ø 190 mm	Ø 170 mm
Dimensions	Ø 250 mm x 96 mm	Ø 226 mm x 100 mm	Ø 202 mm x 100 mm
Colour	white	white	white
Weight	1.12 kg	1.1 kg	1.05 kg

EDL-65TW

Order No. 0162220



Movable PA ceiling speaker

- 100 V transmission technology
- High power rating with 30 W max.
- High-quality 2-way coaxial speaker system with 2-way crossover network
- Complete speaker part can be moved for optimising the sound radiation pattern indoors
- Plastic housing of superior design with metal grille
- Plastic material of ABS and self-extinguishing according to UL 94V-0
- For a ceiling thickness from 9 to 35 mm

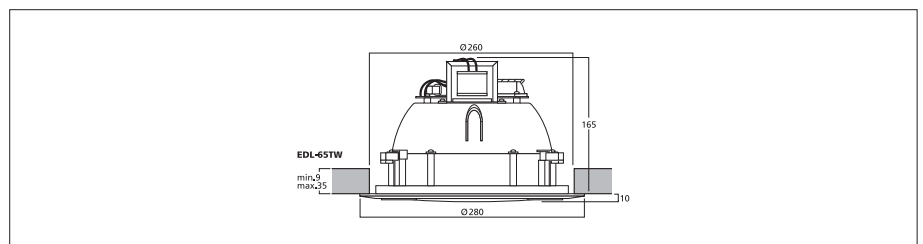

Model	EDL-65TW
Frequency range	50-20,000 Hz
Power rating (RMS)	30/15/7.5 W
SPL	91 dB/W/m
Mounting cutout	Ø 260 mm
Dimensions	Ø 280 mm x 175 mm
Colour	white
Weight	2.38 kg

Speakers

Wall and Ceiling Speakers

ESP-8U

Order No. 0162170



PA wall and ceiling speaker for flush mounting

- 100 V transmission technology via audio transformer with 3 power taps
- Perfect sound presence for a powerful voice reproduction with a very high audibility
- 20 cm speaker of a very high sound pressure level (99 dB/W/m)
- Plastic tray for flush mounting in walls or solid ceilings
- Required hole in wall: approx. 242 x 242 x 100 mm
- Metal front grille with plastic frame

Model	ESP-8U
Frequency range	200-17,000 Hz
Power rating (RMS)	6/3/1.5 W
SPL	99 dB/W/m
Mounting cutout	242 x 242 mm
Dimensions	248 x 248 x 100 mm
Colour	white/black
Weight	1.7 kg

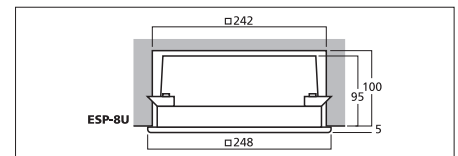
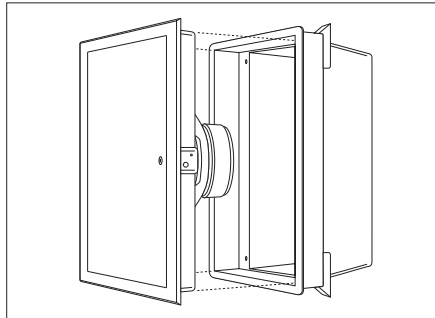

ESP-5U

Order No. 0162160



PA wall and ceiling speaker for flush mounting

- 100 V transmission technology via audio transformer with 3 power taps
- Wide bandwidth radiation for a pleasant music reproduction
- 13 cm speaker of a high sound pressure level (94 dB/W/m)
- Plastic tray for flush mounting in walls or solid ceilings
- Required hole in wall: approx. 242 x 242 x 100 mm
- Metal front grille with plastic frame

Model	ESP-5U
Frequency range	100-19,000 Hz
Power rating (RMS)	6/3/1.5 W
SPL	94 dB/W/m
Mounting cutout	242 x 242 mm
Dimensions	248 x 248 x 100 mm
Colour	white/black
Weight	1.4 kg

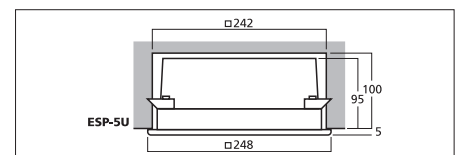
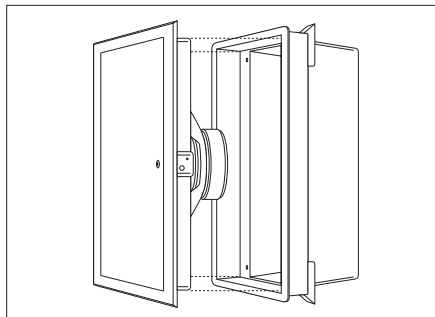

ESP-32/WS

Order No. 0161680



ESP-22/WS

Order No. 0161670



ESP-17/WS

Order No. 0161660



ESP-15/WS

Order No. 0161550



PA hi-fi wall and ceiling speakers

- 100 V transmission technology, 2-way version with dome tweeter (pivoting with ESP-17/WS, ESP-22/WS and ESP-32/WS)
- Plastic housing with protective metal grille

- ABS plastic material, self-extinguishing according to UL 94V-0
- Excellent sound characteristics
- For a wall thickness/ceiling thickness from 8 to 35 mm

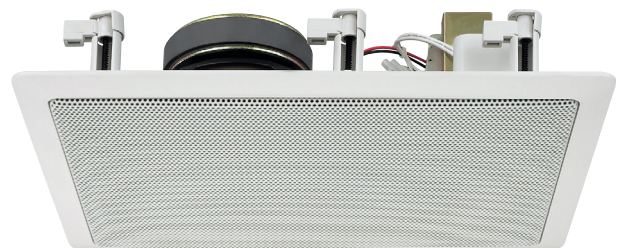

Model	ESP-32/WS	ESP-22/WS	ESP-17/WS	ESP-15/WS
Frequency range	40-20,000 Hz	50-20,000 Hz	55-20,000 Hz	60-20,000 Hz
Power rating (RMS)	30/15/7.5/4/2 W	20/15/10/5/2.5 W	15/7.5/4/2/1 W	15/7.5/4/2/1 W
SPL	89 dB/W/m	88 dB/W/m	87 dB/W/m	87 dB/W/m
Mounting cutout	330 x 225 mm	275 x 190 mm	270 x 185 mm	115 x 190 mm
Dimensions	358 x 256 x 100 mm	306 x 220 x 100 mm	300 x 214 x 90 mm	146 x 220 x 70 mm
Colour	white	white	white	white
Weight	2.8 kg	2.6 kg	1.9 kg	1.3 kg

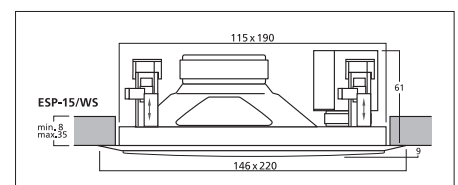

SPE-252HQ

Order No. 0105800



Hi-fi wall and ceiling speaker, 50 W, 8 Ω

- 2-way version with dual bass speaker and dome tweeter
- 2 x 13 cm (5") bass speaker and 25 mm (1") silk dome
- Excellent sound characteristics
- Protective metal grille
- Protective grille magnetically attached to the speaker front
- Ideally suited e.g. as a centre speaker
- For a wall thickness/ceiling thickness from 6 to 35 mm

Model	SPE-252HQ
Frequency range	60-20,000 Hz
Resonant frequency (fs)	65 Hz
Power rating (RMS)	50 W
Peak music power output (MAX)	100 W
SPL	88 dB/W/m
Mounting cutout	365 x 157 mm
Dimensions	391 x 183 x 75 mm
Colour	white/black
Weight	2.6 kg

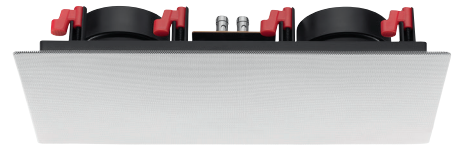
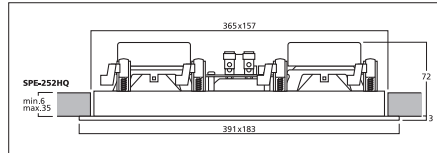

EDL-310L

Order No. 0162490



Super dispersion PA ceiling speaker

- 100 V transmission technology, with 3 power taps up to 10 W
- High-quality full range speaker (20 cm)
- For all suspended ceilings and for free suspension
- A very good sound with excellent stereophony with all suspended ceiling grids
- Dimensions: 300 mm x 300 mm, required clearance above the ceiling when resting the speaker directly on the grid: >10 cm, when suspending it above the ceiling: >25 cm
- The sound absorption plate is fitted with 3 foam rubber pads for resting the speaker on the grid and 3 predrilled holes for suspending it

Model	EDL-310L
Frequency range	50-18,000 Hz
Power rating (RMS)	10/5/2.5 W
SPL	98 dB/W/m
Dimensions	300 x 300 x 95 mm
Colour	black
Weight	1.535 kg

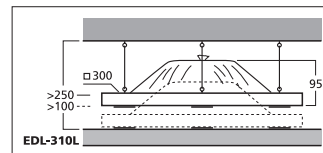

SPE-8U

Order No. 0105640



Hi-fi wall and ceiling speaker for flush mounting, 8 Ω

- High-quality 2-way coaxial speaker system with excellent sound characteristics
- 20 cm (8") bass speaker with glass fibre cone, 24 mm (1") dome tweeter with titanium cone
- Plastic tray for flush mounting in walls or solid ceilings
- Required hole in wall: approx. 242 x 242 x 100 mm
- Metal front grille with plastic frame

Model	SPE-8U
Frequency range	70-20,000 Hz
Resonant frequency (fs)	60 Hz
Power rating (RMS)	30 W
Peak music power output (MAX)	60 W
SPL	89 dB/W/m
Mounting cutout	242 x 242 mm
Dimensions	248 x 248 x 100 mm
Colour	white
Weight	1.6 kg

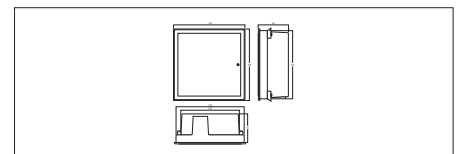

SPE-32/WS

Order No. 0105630



Hi-fi wall and ceiling speakers, 8 Ω

- 2-way version with dome tweeter (pivoting with SPE-22/WS and SPE-32/WS)
- Plastic housing with protective metal grille
- ABS plastic material, self-extinguishing according to UL 94V-0
- Excellent sound characteristics
- For a wall thickness/ceiling thickness from 8 to 35 mm

SPE-22/WS

Order No. 0105620



SPE-15/WS

Order No. 0105600



Model	SPE-32/WS	SPE-22/WS	SPE-15/WS
Frequency range	40-20,000 Hz	50-20,000 Hz	60-20,000 Hz
Resonant frequency (fs)	37 Hz	51 Hz	90 Hz
Power rating (RMS)	50 W	40 W	25 W
Peak music power output (MAX)	100 W	80 W	50 W
SPL	89 dB/W/m	88 dB/W/m	87 dB/W/m
Mounting cutout	330 x 225 mm	275 x 190 mm	115 x 190 mm
Dimensions	358 x 256 x 97 mm	306 x 220 x 87 mm	146 x 220 x 70 mm
Colour	white	white	white
Weight	2.19 kg	1.9 kg	0.83 kg

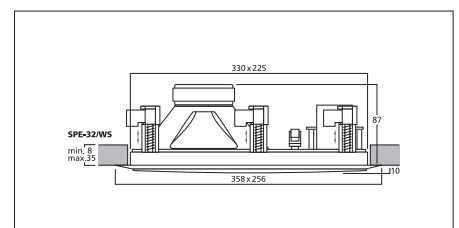

Speakers

Wall and Ceiling Speakers

SPE-150/WS

Order No. 0101620



SPE-158/WS

Order No. 0103150



Flush-mount full range speakers, 15 W

- Dual cone
- Slimline design with fixed metal grille



Model	SPE-150/WS	SPE-158/WS
Frequency range	100-12,000 Hz	100-12,000 Hz
Power rating (RMS)	15 W	15 W
Peak music power output (MAX)	30 W	30 W
SPL	89 dB/W/m	88 dB/W/m
Mounting cutout	Ø 120 mm	Ø 120 mm
Dimensions	Ø 153 mm x 45 mm	Ø 153 mm x 45 mm
Colour	white	white
Weight	500 g	500 g

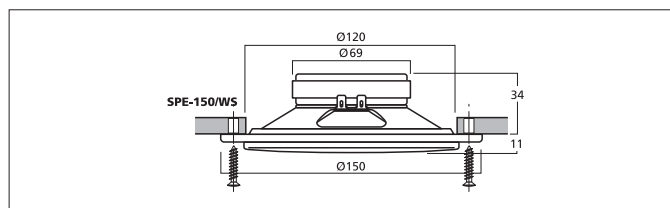

SPE-140/WS

Order No. 0104470



Flush-mount speaker, 10 W

- Dual cone for a full range reproduction
- Slimline design
- Fixed metal grille
- Suitable for indoor announcements and background music



Model	SPE-140/WS
Frequency range	120-12,000 Hz
Power rating (RMS)	10 W
Peak music power output (MAX)	20 W
SPL	87 dB/W/m
Mounting cutout	Ø 110 mm
Dimensions	Ø 140 mm x 40 mm
Colour	white
Weight	311 g

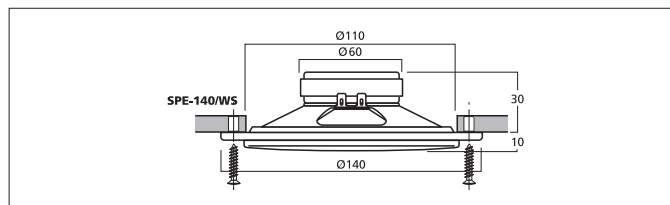

SPE-82/WS

Order No. 0161540



Small flush-mount speaker, 6 W, 4 Ω

- White (WS) cover
- Similar design to standard flush-mounted halogen lights
- Suitable for speech and background music, very consistent frequency response
- Quick-mounting facility



Model	SPE-82/WS
Frequency range	130-20,000 Hz
Power rating (RMS)	6 W
Peak music power output (MAX)	12 W
SPL	87 dB/W/m
Mounting cutout	Ø 96 mm
Dimensions	Ø 100 mm x 57 mm
Colour	white/black
Weight	340 g

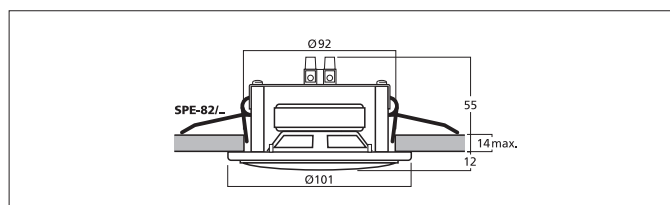

SPE-15F/WS

Order No. 0162840



Pair of weatherproof flush-mount PA speakers, 15 W, with UV-stabilised plastic housing, super slimline design.

Versatile use for PA, car hi-fi, terrace, boat, swimming pool areas.

- Weatherproof polypropylene spaker cone
- Tested according to ASTM B117 (400 h salt spray test)
- Low stray magnetic field
- Supplied with stainless mounting accessories and connection cable



Model	SPE-15F/WS
Frequency range	80-16,000 Hz
Power rating (RMS)	15 W
Peak music power output (MAX)	30 W
SPL	86 dB/W/m
Mounting cutout	Ø 111 mm
Dimensions	Ø 150 mm x 45 mm
Colour	white
Weight	270 g

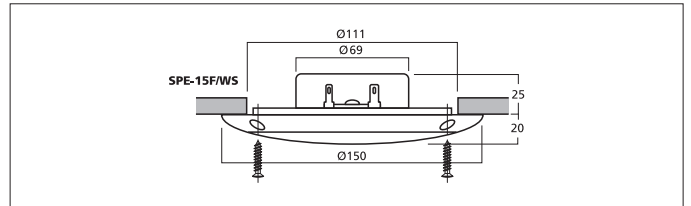

CRB-230/WS

Order No. 0130920



Pairs of flush-mount speakers, coaxial system, 4 Ω, tweeter with ferrofluid.

- Moisture-proof
- White one-piece plastic design and plastic cone
- Versatile use for car hi-fi, PA, terrace, boat



Model	CRB-230/WS
Frequency range	100-20,000 Hz
Power rating (RMS)	25 W
Peak music power output (MAX)	50 W
SPL	89 dB/W/m
Mounting cutout	Ø 110 mm
Dimensions	Ø 150 mm
Colour	white
Weight	0.5 kg

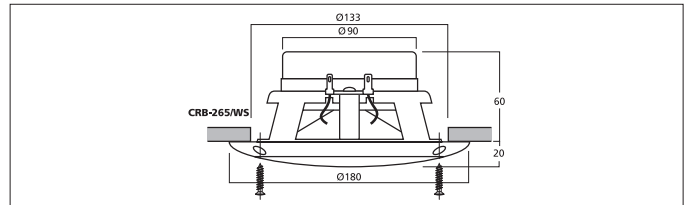

SPE-265/WS

Order No. 0102690



SPE-230/WS

Order No. 0102700



Pair of flush-mount speakers, coaxial system, 8 Ω, tweeter with ferrofluid.

- Moisture-proof
- White one-piece plastic design and plastic cone
- Versatile use for car hi-fi, PA, terrace, boat



Model	SPE-265/WS	SPE-230/WS
Frequency range	80-20,000 Hz	100-20,000 Hz
Power rating (RMS)	30 W	25 W
Peak music power output (MAX)	60 W	50 W
SPL	87 dB/W/m	85 dB/W/m
Mounting cutout	Ø 133 mm	Ø 110 mm
Dimensions	Ø 180 mm x 80 mm	Ø 150 mm x 66 mm
Colour	white	white
Weight	0.8 kg	0.5 kg

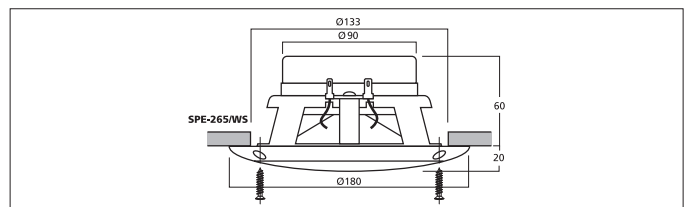

Speakers

Wall and Ceiling Speakers

SPE-284/WS

Order No. 0105520



SPE-264/WS

Order No. 0104900



Pair of weatherproof PA ceiling speakers, heat-resistant up to 100 °C.

For applications in saunas and swimming pool areas.

- 2-way system with dome tweeter
- Excellent sound
- White plastic housing
- Weatherproof speaker cone
- Tested according to ASTM B117 (400 h salt spray test)
- For a ceiling thickness from 2 to 25 mm
- Spring-loaded speaker terminal



Model	SPE-284/WS	SPE-264/WS
Frequency range	45-20,000 Hz	60-20,000 Hz
Power rating (RMS)	50 W	45 W
Peak music power output (MAX)	100 W	90 W
SPL	89 dB/W/m	88 dB/W/m
Mounting cutout	Ø 220 mm	Ø 190 mm
Dimensions	Ø 250 mm x 96 mm	Ø 226 mm x 100 mm
Colour	white	white
Weight	0.95 kg	0.9 kg

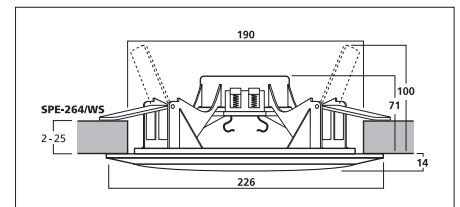

SPE-72/WS

Order No. 0162310



Weatherproof flush-mount full range speaker with dual cone, 20 W, 4 Ω

- Weatherproof speaker of compact size and a high power capability with a wide bandwidth and particularly brilliant reproduction due to a twin cone
- High-quality one-piece white plastic basket with magnetic sleeve
- Polypropylene cone and mica dual cone
- Rubber surround, supplied with matching plastic grille (to be glued in)
- Also suitable for PA applications in a humid environment and outdoors

Model	SPE-72/WS
Frequency range	100-20,000 Hz
Resonant frequency (fs)	100 Hz
Power rating (RMS)	20 W
Peak music power output (MAX)	40 W
SPL	86 dB/W/m
Mounting cutout	Ø 73 mm
Dimensions	Ø 90 mm x 50 mm
Colour	black/silver/white
Weight	230 g

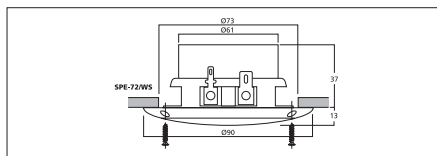

SPE-70/WS

Order No. 0162300



Weatherproof flush-mount full range speaker and bass-midrange speaker, 20 W, 8 Ω

- Weatherproof speaker of compact size and high power capability with a wide bandwidth reproduction
- High-quality one-piece white plastic basket with magnetic sleeve
- Polypropylene cone, rubber surround, supplied with matching plastic grille (to be glued in)
- Also suitable for PA applications in a humid environment and outdoors
- As a bass-midrange speaker also suitable in small hi-fi systems

Model	SPE-70/WS
Frequency range	100-20,000 Hz
Resonant frequency (fs)	100 Hz
Power rating (RMS)	20 W
Peak music power output (MAX)	40 W
SPL	86 dB/W/m
Mounting cutout	Ø 73 mm
Dimensions	Ø 90 mm x 50 mm
Colour	white/black
Weight	230 g

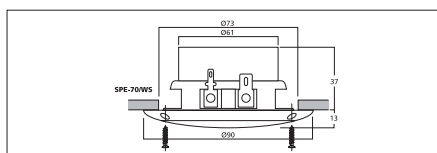

SPE-110P/SW

Order No. 0162530



SPE-110P/WS

Order No. 0162540



Weatherproof flush-mount speakers, 15 W, 4 Ω, heat-resistant up to 120 °C.

For saunas and swimming pool areas, as well as other areas where a reliable operation at high temperatures must be ensured.

- Black (SW) or white (WS) plastic housing
- ABS plastic material, self-extinguishing according to UL 94V-0

Model	SPE-110P/SW, SPE-110P/WS
Frequency range	180-18,000 Hz
Resonant frequency (fs)	250 Hz
Power rating (RMS)	15 W
Peak music power output (MAX)	30 W
SPL	86 dB/W/m
Mounting cutout	Ø 101 mm
Dimensions	Ø 132 mm
Colour	black
Weight	285 g

- Weatherproof speaker cone
- Tested according to ASTM B117 (400 h salt spray test)

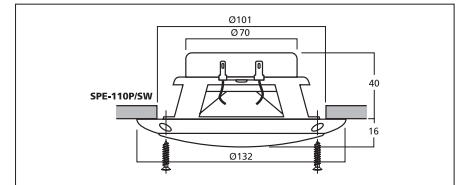

This high-quality Bluetooth audio system

consists of an active ceiling speaker and a passive ceiling speaker with Bluetooth receiver and serves as a plug-and-play stereo pair for background PA applications.

A robust ABS housing with moisture-resistant bass speaker and coaxially mounted tweeter as well as the magnetically attached metal protective grille and the excellent workmanship all ensure an overall high-quality appearance and optimum handling.

The frameless speaker grille allows for an unobtrusive appearance when mounted into the ceiling or wall.

A wireless connection between audio players like smartphones, tablets, PCs, Android devices or Apple devices such as iPads or iPhones can be established via Bluetooth 4.0 technology. A new initialisation is not required. Depending on the room, the operating range can be up to 10 m.

The integrated amplifier switches to standby mode in case of inactivity to save energy.

SPE-230BT

Order No. 0163320



Bluetooth hi-fi flush-mount speaker stereo set, consists of a 2-way active speaker with integrated amplifier, Bluetooth module and crossover network, a 2-way passive speaker with crossover network as well as a matching power supply.

- Pair of 2-way hi-fi speakers for wall mounting and ceiling suspension
- 13 cm (5¼") bass-midrange speaker, 2.54 cm (1") coaxial tweeter
- Master/slave mode (active speaker and passive speaker are combined to create a stereo pair)
- Active speaker with integrated class D amplifier module, 2 x 20 W
- Bluetooth 4.0, APTX
- Operating range: 10 m, class 1
- High-quality crossover network
- Frameless protective metal grille, magnetically attached
- Quick-mount system
- 4-digit PIN code for initial linking
- Recognition of devices which have previously been linked
- 230 V power supply with earthed plug and plug-in connector for active speaker

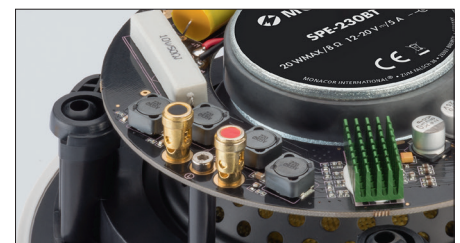
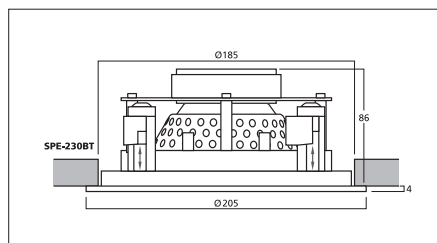

Model	SPE-230BT
Power rating (RMS)	2 x 20 W
Frequency range	50-20,000 Hz
SPL	89 dB/W/m
Housing material	plastic
Mounting device	quick-mount system
Admiss. ambient temp.	0-40 °C
Power supply	encl. power supply
Dimensions	Ø 205 mm x 90 mm
Weight	1.26 kg (active speak.) 1.18 kg (passive speak.)

Speakers

Wall and Ceiling Speakers

List of flush-mount PA ceiling speakers, sorted by mounting dimensions

Model	Order No.	Power rating	Connection	Width	Height	Mounting cutout	Mounting depth	Frame	Front grille
EDL-22/WS	0162770	6/3/1.5 W	100 V	Ø 83 mm	-	Ø 73 mm	67 mm	plastic	plastic
EDL-82/WS	0161490	6/3/1.5 W	100 V	Ø 100 mm	-	Ø 96 mm	98 mm	plastic	metal
EDL-204	0161630	20/15/10/5/2.5 W	100 V	Ø 132 mm	-	Ø 104 mm	102 mm	plastic	plastic
EDL-206	0161650	20/15/10/5/2.5 W	100 V	Ø 180 mm	-	Ø 132 mm	110 mm	plastic	plastic
EDL-42HQ	0163890	15 W (8 Ω) 8/4/2/1 W (100 V)	100 V/8 Ω	Ø 158 mm	-	Ø 141 mm	69 mm	-	metal/plastic
EDL-24	0161430	6/3/1.5 W	100 V	Ø 170 mm	-	Ø 142 mm	60 mm	plastic	metal
EDL-165AB/WS	0163650	2 x 6/3/1.5 W	100 V	Ø 170 mm	-	Ø 140-150 mm	90 mm	metal, white, RAL 9010	metal, white, RAL 9010
EDL-165C/WS	0160090	6/3/1.5 W	100 V	Ø 170 mm	-	Ø 150 mm	90 mm	metal	metal
EDL-15	0163810	6/3/1.5 W	100 V	Ø 182 mm	-	Ø 152 mm	50 mm	metal	metal
EDL-25	0161440	6/3/1.5 W	100 V	Ø 205 mm	-	Ø 165 mm	60 mm	plastic	metal
EDL-16	0163820	10/6/3/1.5 W	100 V	Ø 195 mm	-	Ø 166 mm	55 mm	metal	metal
EDL-116TW	0163840	15/10/6/3 W	100 V	Ø 195 mm	-	Ø 166 mm	55 mm	metal	metal
EDL-155	0162920	15/10/5/2.5/1.25 W	100 V	Ø 202 mm	-	Ø 170 mm	95 mm	plastic	plastic
EDL-6	1000263	8 W	100 V	Ø 193 mm	-	Ø 170 mm	65 mm	plastic	metal
EDL-706/12	0163370	6/3/1.5 W	100 V	Ø 200 mm	-	Ø 170 mm	60 mm	metal	metal
EDL-612	0161810	12/6/3 W	100 V	Ø 200 mm	-	Ø 180 mm	50 mm	metal	metal
EDL-620	0162590	20/10/5 W	100 V	Ø 200 mm	-	Ø 180 mm	50 mm	metal	metal
EDL-606EN	0163160	6/3/1.5 W	100 V	Ø 200 mm	-	Ø 180 mm	60 mm	metal	metal
EDL-612EN	0163170	12/6/3 W	100 V	Ø 200 mm	-	Ø 180 mm	60 mm	metal	metal
EDL-620EN	0163180	20/10/5 W	100 V	Ø 200 mm	-	Ø 180 mm	60 mm	metal	metal
EDL-36TW	0162070	10/5/2.5 W	100 V	Ø 200 mm	-	Ø 190 mm	90 mm	metal	metal
EDL-156	0161910	15/10/5/2.5/1.25 W	100 V	Ø 226 mm	-	Ø 190 mm	75 mm	plastic	plastic
EDL-70/WS	0163310	6/3/1.5 W	100 V	Ø 220 mm	-	Ø 195 mm	100 mm	metal	metal
EDL-26	0161450	10/5/2.5/1.25 W	100 V	Ø 230 mm	-	Ø 200 mm	75 mm	plastic	metal
EDL-62HQ	0163430	35 W (8 Ω) 30/16/8/4 W (100 V)	100 V/8 Ω	Ø 250 mm	-	Ø 210 mm	95 mm	-	metal/plastic
EDL-158	0162930	15/10/5/2.5/1.25 W	100 V	Ø 250 mm	-	Ø 220 mm	85 mm	plastic	plastic
EDL-18	0163830	10/6/3/1.5 W	100 V	Ø 252 mm	-	Ø 216 mm	85 mm	metal	metal
EDL-118TW	0163850	15/10/6/3 W	100 V	Ø 252 mm	-	Ø 216 mm	85 mm	metal	metal
EDL-224ABC	0160100	2x6/2x3/2x1.5 W	100 V	Ø 252 mm	-	Ø 230 mm	110 mm	metal	metal
EDL-11TW	0161210	10/5/2.5 W	100 V	Ø 264 mm	-	Ø 225 mm	110 mm	metal	metal
EDL-11TW/SW	0162410	10/5/2.5 W	100 V	Ø 264 mm	-	Ø 225 mm	105 mm	metal	metal
EDL-250C/WS	0160110	6/3/1.5 W	100 V	Ø 252 mm	-	Ø 230 mm	110 mm	metal	metal
EDL-28	0161460	10/5/2.5/1.25 W	100 V	Ø 275 mm	-	Ø 240 mm	75 mm	plastic	metal
EDL-82HQ	0163440	50 W (8 Ω) 30/16/8/4 W (100 V)	100 V/8 Ω	Ø 295 mm	-	Ø 252 mm	97 mm	-	metal/plastic
EDL-65TW	0162220	30/15/7.5 W	100 V	Ø 280 mm	-	Ø 260 mm	165 mm	plastic	metal
ESP-15/WS	0161550	15/7.5/4/2/1 W	100 V	146 mm	220 mm	115 x 190 mm	61 mm	plastic	metal
ESP-17/WS	0161660	15/7.5/4/2/1 W	100 V	300 mm	214 mm	270 x 185 mm	80 mm	plastic	metal
ESP-22/WS	0161670	20/15/10/5/2.5 W	100 V	306 mm	220 mm	275 x 190 mm	90 mm	plastic	metal
ESP-32/WS	0161680	30/15/7.5/4/2 W	100 V	358 mm	256 mm	330 x 225 mm	90 mm	plastic	metal
SPE-15/WS	0105600	25 W/50 W (RMS/MAX)	8 Ω	146 mm	220 mm	115 x 190 mm	61 mm	plastic	metal
SPE-22/WS	0105620	40 W/80 W (RMS/MAX)	8 Ω	306 mm	220 mm	275 x 190 mm	77 mm	plastic	metal
SPE-32/WS	0105630	50 W/100 W (RMS/MAX)	8 Ω	358 mm	256 mm	330 x 225 mm	87 mm	plastic	metal
SPE-252HQ	0105800	50 W/100 W (RMS/MAX)	8 Ω	391 mm	183 mm	365 x 157 mm	72 mm	plastic	metal
SPE-72/WS	0162310	20 W/40 W (RMS/MAX)	4 Ω	Ø 90 mm	-	Ø 73 mm	37 mm	plastic	plastic
SPE-70/WS	0162300	20 W/40 W (RMS/MAX)	8 Ω	Ø 90 mm	-	Ø 73 mm	37 mm	plastic	plastic
SPE-82/WS	0161540	6 W/12 W (RMS/MAX)	4 Ω	Ø 100 mm	-	Ø 96 mm	57 mm	plastic	-
SPE-110P/SW	0162530	15 W/30 W (RMS/MAX)	4 Ω	Ø 132 mm	-	Ø 101 mm	40 mm	plastic	plastic
SPE-110P/WS	0162540	15 W/30 W (RMS/MAX)	4 Ω	Ø 132 mm	-	Ø 101 mm	40 mm	plastic	plastic
SPE-140/WS	0104470	10 W/20 W (RMS/MAX)	4 Ω	Ø 140 mm	-	Ø 110 mm	30 mm	metal	metal
CRB-230/WS	0130920	25 W/50 W (RMS/MAX)	4 Ω	Ø 150 mm	-	Ø 110 mm	50 mm	plastic	plastic
CRB-130/WS	0130900	20 W/40 W (RMS/MAX)	4 Ω	Ø 150 mm	-	Ø 110 mm	50 mm	plastic	plastic
SPE-15F/WS	0162840	15 W/30 W (RMS/MAX)	4 Ω	Ø 150 mm	-	Ø 111 mm	25 mm	plastic	plastic
SPE-230/WS	0102700	25 W/50 W (RMS/MAX)	8 Ω	Ø 150 mm	-	Ø 110 mm	50 mm	plastic	plastic
SPE-150/WS	0101620	15 W/30 W (RMS/MAX)	4 Ω	Ø 153 mm	-	Ø 120 mm	34 mm	metal	metal
SPE-158/WS	0103150	15 W/30 W (RMS/MAX)	8 Ω	Ø 153 mm	-	Ø 120 mm	34 mm	metal	metal
SPE-265/WS	0102690	30 W/60 W (RMS/MAX)	8 Ω	Ø 180 mm	-	Ø 133 mm	60 mm	plastic	plastic
SPE-264/WS	0104900	45 W/90 W (RMS/MAX)	4 Ω	Ø 226 mm	-	Ø 190 mm	71 mm	plastic	plastic
SPE-284/WS	0105520	50 W/100 W (RMS/MAX)	4 Ω	Ø 250 mm	-	Ø 220 mm	85 mm	plastic	plastic
IT-10M	0160470	10/5/2.5 W	100 V	120 mm	120 mm	Ø 101 mm	-	plastic	-
NR-10M	0160480	10 W/20 W (RMS/MAX)	4 Ω	120 mm	120 mm	Ø 101 mm	-	plastic	-
SPE-230BT	0163320	2 x 45 W	Bluetooth	Ø 205 mm	-	Ø 180 mm	86 mm	plastic	metal
EDL-80DT	0163480	30 W	Dante®	Ø 272 mm	-	Ø 240 mm	255 mm	plastic	metal

Important note:

Dimensions may deviate due to manufacturing tolerances. Ceiling cutouts should not be made prior to receiving the speakers.

ESP-157/WS

Order No. 0163210



PA wall speaker

- 100 V transmission technology via audio transformer with 2 power taps
- Good sound characteristics due to 2-way system
- Plastic cabinet of a special design with protective metal grille
- Closed rear panel, screwed
- Horizontal and vertical mounting possible

Model	ESP-157/WS
Power rating (RMS)	15/7.5 W
Frequency range	100-20,000 Hz
SPL	91 dB/W/m
Dimensions	240 x 340 x 105 mm
Weight	1.7 kg



ESP-152/WS

Order No. 0162150



PA wall speaker

- 100 V transmission technology via audio transformer with 3 power taps
- High-quality sound and high volume capability due to 2-way coaxial system
- Plastic cabinet of a special design (open rear panel) with protective metal grille
- Symmetrical design allows for horizontal and vertical mounting
- Supplied with mounting screws and cover plates for the screws

Model	ESP-152/WS
Power rating (RMS)	15/7.5/3.75 W
Frequency range	100-20,000 Hz
SPL	91 dB/W/m
Dimensions	240 x 330 x 85 mm
Weight	1.84 kg



ESP-63/WS

Order No. 0163200



PA wall speaker

- 100 V transmission technology via audio transformer with 2 power taps
- 2-way system with good sound characteristics
- Plastic cabinet of special design with protective metal grille
- Closed rear panel, screwed
- Horizontal and vertical mounting possible

Model	ESP-63/WS
Power rating (RMS)	6/3 W
Frequency range	100-20,000 Hz
SPL	91 dB/W/m
Dimensions	240 x 340 x 105 mm
Weight	1.6 kg
Inputs	power taps



ESP-62AB/WS

Order No. 0163660



PA A/B wall speaker, with EN 54-24 certification for voice evacuation systems with A/B speaker distribution according to EN 60849.

- 100 V transmission technology
- 13 cm full range speaker with dual voice coil
- 2 separate transformers with power taps with 6/3/1.5 W each
- Connection via 2 ceramic screw terminals inside the cabinet
- Symmetrical design allows for horizontal and vertical mounting

Model	ESP-62AB/WS
Power rating (RMS)	2 x 6/3/1.5 W
Frequency range	80-19,000 Hz
SPL	93 dB/W/m
Dimensions	240 x 330 x 83 mm
Weight	1.5 kg

- Plastic cabinet with open rear panel and protective metal front grille
- Supplied with screws and wall plugs

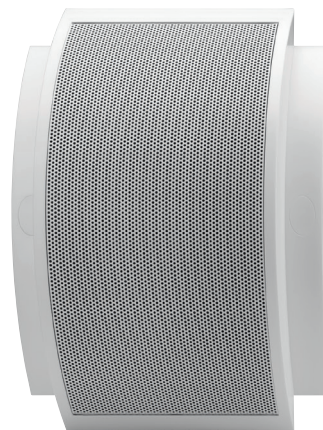

Speakers

Wall and Ceiling Speakers

ESP-62/WS

Order No. 0163030



PA wall speaker, with EN 54-24 certification.

- 100 V transmission technology via audio transformer with 3 power taps
- Full range speaker with a high-quality sound and a clear voice reproduction
- Plastic cabinet of a special design (open rear panel) with protective metal grille
- Symmetrical design allows for horizontal and vertical mounting
- Supplied with mounting screws and screw head covers
- Ball-proof according to DIN 18032, Part 3

Model	ESP-62/WS
Power rating (RMS)	6/3/1.5 W
Frequency range	100-19,000 Hz
SPL	93 dB/W/m
Admiss. ambient temp.	-10 °C to +50 °C
Dimensions	240 x 330 x 85 mm
Weight	1.2 kg



ESP-50AB/WS

Order No. 0160120



PA A/B wall speaker, with EN 54-24 certification for voice evacuation systems with A/B speaker distribution according to EN 60849 and DIN VDE 0833-4.

- 100 V transmission technology
- 2 separate full range speakers (10 cm), each with its own transformer 6/3/1.5 W
- Connection via 2 spring-loaded terminals inside the cabinet
- Wooden cabinet with protective metal grille
- Easy wall mounting via supplied metal bracket and mounting accessories

Model	ESP-50AB/WS
Power rating (RMS)	2 x 6/3/1.5 W
Frequency range	120-20,000 Hz
SPL	92 dB/W/m
Admiss. ambient temp.	-10 °C to +50 °C
Dimensions	265 x 165 x 90 mm
Weight	1.9 kg

- Ball-proof according to DIN 18032, Part 3

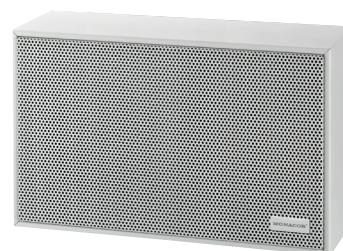

ESP-50EN/WS

Order No. 0160260



PA wall speaker, with EN 54-24 certification.

- 100 V transmission technology
- Full range speaker (13 cm)
- Suitable for voice and music transmissions
- Connection via spring-loaded terminal inside the cabinet
- Wooden cabinet with protective metal grille
- Easy wall mounting via supplied mounting bracket and mounting accessories
- Ball-proof according to DIN 18032, Part 3

Model	ESP-50EN/WS
Power rating (RMS)	6/3/1.5 W
SPL	93 dB/W/m
Housing material	wood
Colour	white, RAL 9010
Admiss. ambient temp.	-10 °C to +50 °C
Dimensions	265 x 165 x 90 mm
Weight	1.6 kg



ESP-72/WS

Order No. 0162130



PA wall speaker

- 100 V transmission technology
- 2-way coaxial speaker, providing a high-quality sound
- 5-step rotary switch for 20/10/5/2.5 W/off
- Rotary switch can be replaced with a cover plate to avoid accidental changing of the power selection
- Emergency priority relay
- White wooden cabinet with protective metal grille
- Mounting plate for easy wall mounting
- Ball-proof according to DIN 18032, Part 3

Model	ESP-72/WS
Power rating (RMS)	20/10/5/2.5 W
Frequency range	85-20,000 Hz
Dimensions	300 x 200 x 90 mm
Weight	2.8 kg



ESP-70/WS

Order No. 0162120



PA wall speaker

- 100 V transmission technology
- 5-step rotary switch for 10/6/4/2 W/off
- Rotary switch can be replaced with a cover plate to avoid accidental changing of the power selection
- Emergency priority relay
- White wooden cabinet with protective metal grille
- Easy wall mounting via supporting plate
- Ball-proof according to DIN 18032, Part 3

Model	ESP-70/WS
Power rating (RMS)	10/6/4/2 W
Frequency range	95-19,000 Hz
Dimensions	300 x 200 x 90 mm
Weight	2.3 kg



ESP-60/WS

Order No. 0161110



PA wall speaker

- 100 V transmission technology via audio transformer with 4 power taps
- White wooden cabinet, without rear panel, foam front cover
- Supplied with mounting screws

Model	ESP-60/WS
Power rating (RMS)	6/4/2/1 W
Frequency range	60-8,000 Hz
Dimensions	300 x 200 x 90 mm
Weight	1.8 kg



ESP-1000AB

Order No. 0163670



PA A/B wall speaker, with EN 54-24 certification for voice evacuation systems with A/B speaker distribution according to EN 60849.

- 100 V transmission technology
- 2 x 10 cm full range speaker
- 2 separate transformers with power taps with 6/3/1.5 W each
- Connection via 2 ceramic screw terminals inside the cabinet
- Plastic cabinet with open rear panel with protective metal front grille

Model	ESP-1000AB
Power rating (RMS)	2 x 6/3/1.5 W
Frequency range	80-20,000 Hz
SPL	92 dB/W/m
Beam angle	160°
Admiss. ambient temp.	-10 °C to +50 °C
Dimensions	Ø 220 mm x 100 mm
Weight	1.98 kg

- Supplied with aluminium mounting bracket, screws and wall plugs



ESP-90/WS

Order No. 0162680



PA wall speaker

- 100 V transmission technology via audio transformer with 3 power taps
- White plastic housing (surface-mount version with open rear panel) with protective metal grille
- Supplied with mounting accessories

Model	ESP-90/WS
Power rating (RMS)	6/3/1.5 W
Frequency range	80-19,000 Hz
Dimensions	Ø 168 mm x 72 mm
Weight	600 g



Speakers

Wall and Ceiling Speakers

ESP-360/WS

Order No. 0161900



PA wall speaker

- 100 V transmission technology via audio transformer with 2 power taps
- Full range speaker with dual cone
- White plastic cabinet
- Curved cabinet for a perfect radiation angle

Model	ESP-360/WS
Power rating (RMS)	6/3 W
Frequency range	130-15,000 Hz
Dimensions	185 x 255 x 123 mm
Weight	1.1 kg
Inputs	power taps



ESP-134/WS

Order No. 1000264



PA wall speaker

- 100 V transmission technology via audio transformer with 3 W and 6 W power taps or 4 Ω operation (20 W)
- 2-way system with neodymium bass-midrange speaker and dome tweeter
- White plastic cabinet with protective metal grille
- Super slimline design for unobtrusive wall mounting

Model	ESP-134/WS
Power rating (RMS)	6/3 W (100 V) 20 W (4 Ω)
Power rating (RMS)	6/3 W
Impedance	4 Ω
Frequency range	80-18,000 Hz
SPL	91 dB/W/m
Beam angle	H: 100°/V: 60°
Dimensions	185 x 275 x 38 mm
Weight	1.25 kg
Inputs	spring-loaded terminal

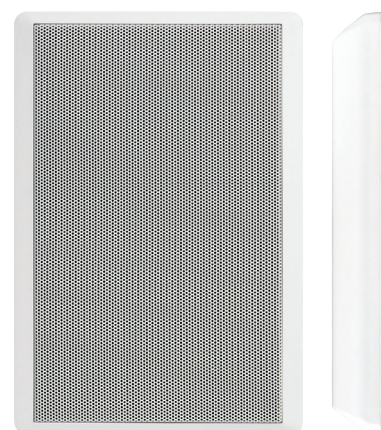

ESP-80/WS

Order No. 0162380



PA wall speaker, vandal-resistant.

- 100 V transmission technology via audio transformer with 4 power taps
- Full range speaker with a good voice reproduction, suitable for background music
- Very robust 2-piece metal housing

Model	ESP-80/WS
Power rating (RMS)	6/3/1.5/0.75 W
Frequency range	250-10,000 Hz
Dimensions	170 x 170 x 63 mm
Weight	1.5 kg



TS-C50-1000/T

Order No. 0163470



TS-C30-700/T

Order No. 0163720



TS-C20-500/T

Order No. 0163730



TS-C10-300/T

Order No. 0163740



Weatherproof PA Column Speakers, with EN 54-24 certification.

- 100 V transmission technology
- 7.7 cm (3") waterproof full range speaker in different quantities
- Connection via ceramic terminals with thermal fuse in the cabinet
- 2 x PG9 cable gland
- Robust, plastic-coated aluminium cabinet with front protective grille
- The speaker complies with British Standard BS 5839, Part 8
- Supplied with plastic wall bracket for pivoting and tilting

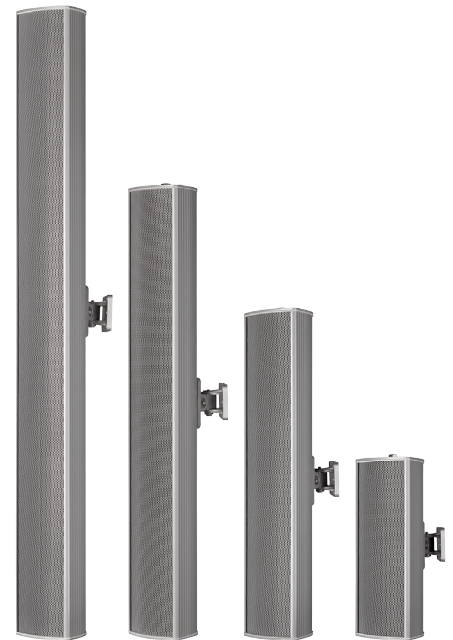
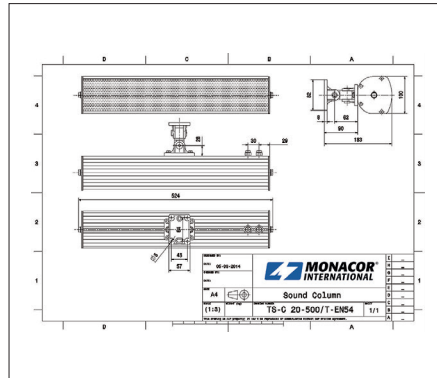

Model	TS-C50-1000/T	TS-C30-700/T	TS-C20-500/T	TS-C10-300/T
Power rating (RMS)	50/30/15/7.5 W	30/15/7.5 W	20/15/10/5 W	10/6/3/1.5 W
Frequency range	200-20,000 Hz	200-17,000 Hz	200-17,000 Hz	200-18,000 Hz
Number of built-in speakers	8	6	4	2
SPL	100 dB/W/m	97 dB/W/m	97 dB/W/m	95 dB/W/m
Beam angle	H: 173°/V: 17°	H: 160°/V: 26°	H: 149°/V: 38°	H: 149°/V: 66°
Admiss. ambient temp.	-20 °C to +90 °C	-20 °C to +90 °C	-20 °C to +90 °C	-20 °C to +90 °C
Dimensions	100 x 971 x 92 mm	100 x 700 x 92 mm	100 x 510 x 92 mm	100 x 296 x 92 mm
Weight	5.1 kg	3.8 kg	2.8 kg	1.6 kg

ETS-360TW/WS

Order No. 0162270



High-end column speaker, (indoors), 100 V. Column speaker in a wooden cabinet of compact size, coated with high-quality foils in decorative wood pattern, 2½-way technology with tweeter (25 mm textile dome), clearly extended frequency range compared with standard full range column speakers. The ETS-360TW/WS speaker impresses with an incredibly dynamic and complete sound, a convincing speech intelligibility and an amazing sound even at higher volume levels.

- 2 bass speakers, 4 bass-midrange speakers, 1 tweeter
- Spring-loaded terminal with 3 power taps
- 2 x M8 threaded bushing
- Supplied with mounting bracket
- Metal front grille

Model	ETS-360TW/WS
Power rating (RMS)	60/30/15 W
Frequency range	90-19,000 Hz
Number of speakers	6+1
SPL	94 dB/W/m
Dimensions	135 x 825 x 110 mm
Weight	7.3 kg



ETS-340TW/WS

Order No. 0162250



High-end column speaker, (indoors), 100 V. Column speaker in a wooden cabinet of compact size, coated with high-quality foils in decorative wood pattern, 2½-way technology with tweeter (25 mm textile dome), clearly extended frequency range compared with standard full range column speakers. The sound is ideally matched to the reproduction of both music and vocals.

- 4 bass speakers, 2 bass-midrange speakers, 1 tweeter
- Spring-loaded terminal with 3 power taps
- 2 x M8 threaded bushing
- Supplied with mounting bracket
- Metal front grille

Model	ETS-340TW/WS
Power rating (RMS)	40/20/10 W
Frequency range	100-19,000 Hz
Number of speakers	6+1
SPL	92 dB/W/m
Dimensions	95 x 500 x 120 mm
Weight	3.5 kg



Speakers

Column Speakers

ETS-442TW/WS

Order No. 0163140



ETS-432TW/WS

Order No. 0163130



ETS-422TW/WS

Order No. 0163120



Weatherproof PA column speakers, with a top-quality sound.

- Weatherproof and hose-proof, extruded aluminium cabinet
- 100 V transmission technology
- 2-way version (with additional integrated tweeter for a clearly improved sound)
- Integrated crossover network
- Aluminium front grille
- Supplied with a robust aluminium wall bracket for pivoting and tilting
- Connection via cable with 4 power taps



Model	ETS-442TW/WS	ETS-432TW/WS	ETS-422TW/WS
Power rating (RMS)	40/20/10/5 W	30/15/7.5/3.75 W	20/10/5/2.5 W
Frequency range	110-20,000 Hz	120-20,000 Hz	130-20,000 Hz
Number of built-in speakers	8+1	6+1	4+1
SPL	93 dB/W/m	93 dB/W/m	92 dB/W/m
Admiss. ambient temp.	-20 °C to +50 °C	-20 °C to +50 °C	-20 °C to +50 °C
Dimensions	124 x 1,016 x 108 mm	124 x 813 x 108 mm	124 x 610 x 108 mm
Weight	6.9 kg	5.5 kg	4 kg

ETS-240TW/WS

Order No. 0162960



ETS-220TW/WS

Order No. 0162950



ETS-210TW/WS

Order No. 0162940



PA column speakers, in extruded aluminium cabinets.

- Weatherproof and hose-proof
- 100 V transmission technology
- 2-way version (with additional integrated tweeters for a clearly improved sound)
- Connection cable with 5-step power taps
- 2 x M6 threaded bushing
- Aluminium front grille
- Supplied with mounting brackets

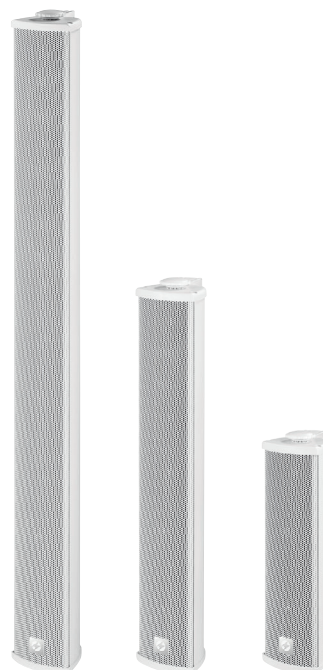

Model	ETS-240TW/WS	ETS-220TW/WS	ETS-210TW/WS
Power rating (RMS)	40/30/20/10/5 W	20/15/10/5/2.5 W	10/5/2.5/1.25/0.63 W
Frequency range	150-20,000 Hz	150-20,000 Hz	170-20,000 Hz
Number of built-in speakers	8+4	4+2	2+1
SPL	90 dB/W/m	89 dB/W/m	86 dB/W/m
Admiss. ambient temp.	-20 °C to +50 °C	-20 °C to +50 °C	-20 °C to +50 °C
Dimensions	80 x 846 x 70 mm	80 x 469 x 70 mm	80 x 280 x 70 mm
Weight	2.7 kg	1.6 kg	1 kg

ETS-530TW/SW

Order No. 0162650

100V 8Ω

ETS-530TW/WS

Order No. 0162660

100V 8Ω

ETS-515TW/SW

Order No. 0162620

100V 8Ω

ETS-515TW/WS

Order No. 0162630

100V 8Ω

PA column speakers

- 100 V transmission technology or 8 Ω operation
- 2-way version (with additional integrated tweeter for a clearly improved sound)
- Integrated crossover network
- 6-step power selector switch with 8 Ω switching
- 2 x 6 mm threaded bushing
- Plastic cabinet and protective metal grille in black (SW) or white (WS)
- Supplied with mounting bracket
- Connection via spring-loaded speaker terminal



Model	ETS-530TW/SW, ETS-530TW/WS	ETS-515TW/SW, ETS-515TW/WS
Total power rating	60 W	30 W
Power rating (RMS)	30/15/7.5/4/2 W (100 V) 30 W (8 Ω)	15/7.5/4/2/1 W (100 V) 15 W (8 Ω)
Frequency range	85-20,000 Hz	90-20,000 Hz
Number of built-in speakers	4+1	2+1
SPL	89 dB/W/m	87 dB/W/m
Dimensions	128 x 620 x 140 mm	128 x 385 x 140 mm
Weight	4.5 kg	2.8 kg

ETS-230TW/WS

Order No. 0162110

100V

ETS-215TW/WS

Order No. 0162100

100V

PA column speakers, in extruded aluminium cabinets, with top and bottom plates of aluminium.

- 100 V transmission technology
- 2-way version (with additional integrated tweeters for a clearly improved sound)
- Integrated crossover network
- 5-step power selector switch
- 2 x M6 threaded bushing
- Metal front grille
- Supplied with mounting brackets
- Connection via cable, 2 cores

ETS-230TW/WS with 4 tweeters
ETS-215TW/WS with 2 tweeters

Model	ETS-230TW/WS	ETS-215TW/WS
Power rating (RMS)	20/10/5/2.5 W	12/6/3/1.5 W
Frequency range	200-20,000 Hz	250-20,000 Hz
Number of built-in speakers	8+4	4+2
SPL	94 dB/W/m	90 dB/W/m
Dimensions	105 x 700 x 75 mm	105 x 410 x 75 mm
Weight	4.2 kg	2.6 kg



ETS-230/WS

Order No. 0161310

100V

ETS-215/WS

Order No. 0161300

100V

PA column speakers, in extruded aluminium cabinets, with top and bottom plates of aluminium.

- 100 V transmission technology
- 5-step power selector switch
- 2 x M6 threaded bushing
- Metal front grille
- Supplied with mounting brackets
- Connection via cable, 2 cores

Model	ETS-230/WS	ETS-215/WS
Power rating (RMS)	30/15/7.5/3.75 W	15/7.5/3.75/2 W
Frequency range	200-15,000 Hz	250-15,000 Hz
Number of built-in speakers	8	4
SPL	95 dB/W/m	92 dB/W/m
Dimensions	105 x 687 x 85 mm	105 x 405 x 85 mm
Weight	3.9 kg	2.5 kg



Speakers

Speaker Systems

WALL-08T/SW

Order No. 1000607



WALL-08T/WS

Order No. 1000608



Pairs of 2-way PA speaker systems

- 100 V wall speaker with plastic cabinet in white (WS) or black (SW)
- 4 power taps as well as switchable to 8 Ω operation
- 20 cm (8") bass-midrange speaker and 25 mm (1") dome tweeter
- High sound quality and speech intelligibility
- Mounting bracket for pivoting and tilting
- Connecting terminal with cover

Model	WALL-08T/SW	WALL-08T/WS
Total power rating	120 W	120 W
Power rating (RMS)	50/25/12.5/6.25 W (100 V)	50/25/12.5/6.25 W (100 V)
	60 W (8 Ω)	60 W (8 Ω)
Impedance	8 Ω	8 Ω
Frequency range	35-20,000 Hz	35-20,000 Hz
SPL	90 dB/W/m	90 dB/W/m
Protection class	IP65	IP65
Dimensions (with bracket)	245 x 378 x 306 mm	245 x 378 x 306 mm
Weight	5 kg	5 kg
Inputs	spring-load, speaker term.	spring-load, speaker term.



WALL-06T/SW

Order No. 0163600



WALL-06T/WS

Order No. 0163610



Pairs of 2-way PA speaker systems

- 100 V wall speaker with plastic cabinet in white (WS) or black (SW)
- 4 power taps as well as switchable to 8 Ω operation
- 16 cm (6") bass-midrange speaker and 25 mm (1") dome tweeter
- High sound quality and speech intelligibility
- Mounting bracket for pivoting and tilting
- Connecting terminal with cover

Model	WALL-06T/SW	WALL-06T/WS
Total power rating	100 W	100 W
Power rating (RMS)	32/16/8/4 W (100 V)	32/16/8/4 W (100 V)
	50 W (8 Ω)	50 W (8 Ω)
Frequency range	70-20,000 Hz	70-20,000 Hz
SPL	90 dB/W/m	90 dB/W/m
Dimensions (with bracket)	196 x 303 x 250 mm	196 x 303 x 250 mm
Weight	3,5 kg	3,5 kg
Inputs	spring-load, speaker term.	spring-load, speaker term.



WALL-05T/SW

Order No. 0163580



WALL-05T/WS

Order No. 0163590



Pairs of 2-way PA speaker systems

- Wall speaker with plastic cabinet in white (WS) or black (SW)
- 4 power taps as well as switchable to 8 Ω operation
- 13 cm (5") bass-midrange speaker and 12 mm (1/2") dome tweeter
- High sound quality and speech intelligibility
- Mounting bracket for pivoting and tilting
- Connecting terminal with cover

Model	WALL-05T/SW	WALL-05T/WS
Total power rating	80 W	80 W
Power rating (RMS)	16/8/4/2 W (100 V)	16/8/4/2 W (100 V)
	40 W (8 Ω)	40 W (8 Ω)
Frequency range	80-20,000 Hz	80-20,000 Hz
SPL	89 dB/W/m	89 dB/W/m
Dimensions (with bracket)	163 x 252 x 203 mm	163 x 252 x 203 mm
Weight	2,6 kg	2,6 kg
Inputs	spring-load, speaker term.	spring-load, speaker term.



WALL-04T/SW

Order No. 0163560



WALL-04T/WS

Order No. 0163570



Pairs of 2-way PA speaker systems

- 100 V wall speaker with plastic cabinet in white (WS) or black (SW)
- 4 power taps as well as switchable to 8 Ω operation
- 10 cm (4") bass-midrange speaker and 12 mm (1/2") dome tweeter
- High sound quality and speech intelligibility
- Mounting bracket for pivoting and tilting
- Connecting terminal with cover

Model	WALL-04T/SW	WALL-04T/WS
Transm. techn.	100 V	100 V
Total power rating	60 W	60 W
Power rating (RMS)	16/8/4/2 W (100 V)	16/8/4/2 W (100 V)
	30 W (8 Ω)	30 W (8 Ω)
Frequency range	90-20,000 Hz	90-20,000 Hz
SPL	87 dB/W/m	87 dB/W/m
Dimensions (with bracket)	130 x 197 x 164 mm	130 x 197 x 164 mm
Weight	1,8 kg	1,8 kg
Inputs	spring-load, speaker term.	spring-load, speaker term.



EUL-60/SW

Order No. 0161170



EUL-60/WS

Order No. 0161180



EUL-30/SW

Order No. 0161150



EUL-30/WS

Order No. 0161160



Pair of universal PA speaker systems

- 100 V transmission technology, 2-way version
- EUL-60... and EUL-30... with 11 mm dome tweeter
- Excellent sound quality
- 6-step power selector switch
- Black (SW) or white (WS) plastic cabinet
- Pivoting mounting bracket
- Bevelled shape of cabinets also allows mounting in corners

Model	EUL-60/SW, EUL-60/WS	EUL-30/SW, EUL-30/WS
Power rating (RMS)	15/7.5/4/2/1 W	15/7.5/4/2/1 W
Frequency range	60-20,000 Hz	80-20,000 Hz
SPL	89 dB/W/m	87 dB/W/m
Dimensions	215 x 290 x 172 mm	130 x 192 x 115 mm
Weight	3.4 kg	3.3 kg (pair)
Inputs	spring-load, speaker term.	spring-load, speaker term.

PAB-82WP/WS

Order No. 0253590



Weatherproof high-performance PA speaker system, 120 W

- 2-way coaxial speaker system in an ABS cabinet
- 20 cm (8") PA coaxial system with impregnated paper cone
- Coaxially integrated 25 mm (1") horn tweeter
- Front grille with water-repellent gauze
- Recessed connection terminal with cover plate and high-strength cable gland
- Metal parts and wall bracket made of stainless steel
- Ball-proof according to DIN 18032, Part 3

Model	PAB-82WP/WS
Total power rating	240 W
Power rating (RMS)	120/60/30 W
Impedance	8 Ω
Frequency range	50-20,000 Hz
SPL	96 dB/W/m
Protection class	IP45
Admiss. ambient temp.	-10 °C to +40 °C
Dimensions	280 x 280 x 270 mm
Weight	9.5 kg



PAB-52WP/WS

Order No. 0253580



Weatherproof high-performance PA speaker system, 50 W

- Wideband bass-reflex system in an ABS cabinet
- 100 V or 4 Ω operation, selectable
- 13 cm (5") high-quality full range speaker with aluminium cone
- Front grille with water-repellent gauze
- Metal parts and wall bracket made of stainless steel
- Ball-proof according to DIN 18032, Part 3

Model	PAB-52WP/WS
Power rating (RMS)	50/25/12.5 W
Impedance	4 Ω
Frequency range	60-18,000 Hz
Number of speakers	1
SPL	87 dB/W/m
Protection class	IP45
Admiss. ambient temp.	-10 °C to +40 °C
Dimensions	200 x 200 x 190 mm
Weight	5.1 kg



Speakers

Speaker Systems

PAB-120WP/SW

Order No. 0253750



Weatherproof high-performance PA speaker system, 120 W

- 2-way bass-reflex system in an ABS cabinet
- 100 V transmission technology
- 30 cm (12") PA bass speaker with impregnated paper cone
- 25 mm (1") horn tweeter system
- Front grille with water-repellent gauze
- Metal parts made of stainless steel
- 4 x M10 threaded insert each at the top and bottom for suspended installation
- Stand sleeve

Model	PAB-120WP/SW
Power rating (RMS)	120/60/30 W
Frequency range	42-20,000 Hz
Number of built-in speakers	2
SPL	98 dB/W/m
Colour	black
Protection class	IP45
Admiss. ambient temp.	-20 °C to +40 °C
Dimensions	370 x 655 x 410 mm
Weight	22.14 kg

- Ball-proof according to DIN 18032, Part 3



EUL-75/WS

Order No. 0162500



PA speaker system

- 100 V transmission technology
- 6-step power selector switch
- Hi-fi full range speaker
- Excellent sound quality
- White grained wooden cabinet with metal front grille
- Floorstanding speaker with wall holder

Model	EUL-75/WS
Power rating (RMS)	10/5/2.5/1.25/0.625 W
Frequency range	70-18,000 Hz
SPL	86 dB/W/m
Dimensions	180 x 290 x 170 mm
Weight	3.7 kg



ESP-315/SW

Order No. 0162860



ESP-315/WS

Order No. 0162870



2-way PA wall-mount speaker systems

- 100 V PA speaker system with an excellent sound
- 2-way system with 10 x 15 cm bass-midrange speaker and 13 mm dome tweeter
- Power taps: 15/10/5/2.5 W
- Power selector switch with 8 Ω operating position
- Can be mounted horizontally or vertically
- Direction of sound radiation can individually be aligned

Model	ESP-315/SW	ESP-315/WS
Total power rating	30 W	30 W
Power rating (RMS)	15/10/5/2.5 W (100 V) 15 W (8 Ω)	15/10/5/2.5 W (100 V) 15 W (8 Ω)
Impedance	8 Ω	8 Ω
Frequency range	75-20,000 Hz	75-20,000 Hz
SPL	90 dB/W/m	90 dB/W/m
Dimensions	Ø 133 mm x 280 mm	Ø 133 mm x 280 mm
Weight	2.1 kg	2.1 kg

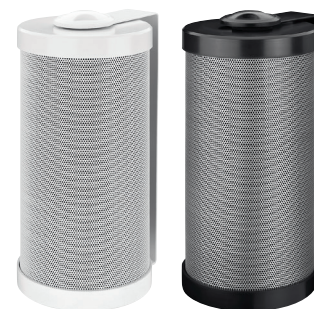

MKS-48/WS

Order No. 0132130



Pair of wall/ceiling/corner mount speaker systems, 15 W, 8 Ω

- Universally mountable into most versatile indoor mounting positions
- A cluster with 1-4 elements can optionally be created
- White ABS cabinet
- High-quality 10 cm full range speaker
- Variable support and mounting system

Model	MKS-48/WS
Total power rating	30 W
Power rating (RMS)	15 W
Impedance	8 Ω
Frequency range	100-20,000 Hz
SPL	87 dB/W/m
Dimensions	195 x 145 x 140 mm
Weight	1.5 kg



ESP-250/WS

Order No. 0162780



ESP-230/WS

Order No. 0190010



ESP-215/WS

Order No. 0199990



PA speaker systems, in a weatherproof white plastic cabinet with aluminium protective grille.

- 100 V transmission technology
- Hose-proof
- Switchable to 8 Ω operation
- 5 power taps, 8 Ω connection and 100 V power selector switch
- 2-way system
- Stainless steel mounting bracket



Model	ESP-250/WS	ESP-230/WS	ESP-215/WS
Total power rating	100 W	100 W	60 W
Power rating (RMS)	50/40/30/20/10 W (100 V) 50 W (8 Ω)	30/20/10/5/2.5 W (100 V) 50 W (8 Ω)	15/10/5/2.5/1.5 W (100 V) 30 W (8 Ω)
Impedance	8 Ω	8 Ω	8 Ω
Frequency range	80-20,000 Hz	80-20,000 Hz	100-20,000 Hz
SPL	92 dB/W/m	92 dB/W/m	87 dB/W/m
Protection class	IP65	IP65	IP65
Admiss. ambient temp.	-20 °C to +50 °C	-20 °C to +50 °C	-20 °C to +50 °C
Dimensions	157 x 260 x 170 mm	157 x 260 x 170 mm	98 x 195 x 105 mm
Weight	2.4 kg	1.8 kg	0.85 kg

ESP-232/SW

Order No. 0162600



ESP-232/WS

Order No. 0162610



Weatherproof 2-way PA wall-mount speaker systems

- 100 V PA speaker system with an excellent sound
- 13 cm polypropylene bass-midrange speaker and tweeter
- 4 power taps
- Power selector switch with 8 Ω operating position

Model	ESP-232/SW	ESP-232/WS
Total power rating	50 W	50 W
Power rating (RMS)	30/20/10/5 W (100 V) 25 W (8 Ω)	30/20/10/5 W (100 V) 25 W (8 Ω)
Impedance	8 Ω	8 Ω
Frequency range	75-20,000 Hz	75-20,000 Hz
Number of built-in speakers	2	2
SPL	89 dB	89 dB
Protection class	IP55	IP55
Admiss. ambient temp.	-20 °C to +50 °C	-20 °C to +50 °C
Dimensions	160 x 260 x 180 mm	160 x 260 x 180 mm
Weight	2.3 kg	2.3 kg



EUL-26/SW

Order No. 0163280



EUL-26/WS

Order No. 0163290



Pair of miniature PA speaker systems

- Speakers for general applications, very small dimensions, 100 V transmission technology
- Can also be connected at 8 Ω
- 6.5 cm (2.5") full range speaker
- Good sound characteristics and speech intelligibility
- Turnable, for pivoting and tilting
- An additional subwoofer system is recommended for complementing the low-frequency music reproduction (e.g. EUL-2SUB/SW, SOUND-100SUB)

Model	EUL-26/SW, EUL-26/WS
Total power rating	20 W
Power rating (RMS)	6 W (100 V) 10 W (8 Ω)
Frequency range	150-20,000 Hz
SPL	88 dB/W/m
Dimensions	90 x 90 x 115 mm
Weight	0.65 kg



Speakers

Speaker Systems

PAB-12WP/SW

Order No. 0253740



Weatherproof high-performance PA speaker system, 200 W, 8 Ω

- 2-way bass-reflex system in an ABS cabinet
- 30 cm (12") PA bass speaker with impregnated paper cone
- 25 mm (1") horn tweeter system
- Front grille with water-repellent gauze
- Metal parts made of stainless steel
- 4 x M10 threaded insert each at the top and bottom for suspended installation
- Stand sleeve
- Ball-proof according to DIN 18032, Part 3

Model	PAB-12WP/SW
Total power rating	400 W
Power rating (RMS)	200 W
Frequency range	42-20,000 Hz
SPL	98 dB/W/m
Protection class	IP45
Admiss. ambient temp.	-10 °C to +40 °C
Dimensions	370 x 655 x 410 mm
Weight	20.32 kg
Inputs	1 x SPEAKER
Outputs	1 x SPEAKER, par. out



PAB-8WP/WS

Order No. 0253570



Weatherproof high-performance PA speaker system, 120 W

- 2-way bass-reflex system in an ABS cabinet
- 100 V or 8 Ω operation, selectable
- 20 cm (8") PA bass speaker with impregnated paper cone
- 25 mm (1") horn tweeter system
- Front grille with water-repellent gauze
- Metal parts and wall bracket made of stainless steel
- Ball-proof according to DIN 18032, Part 3

Model	PAB-8WP/WS
Total power rating	240 W
Power rating (RMS)	120/60/30 W
Frequency range	48-20,000 Hz
SPL	96 dB/W/m
Protection class	IP45
Admiss. ambient temp.	-10 °C to +40 °C
Dimensions	240 x 430 x 250 mm
Weight	11.42 kg
Inputs	1 x SPEAKER, screw terminal
Outputs	1 x SPEAKER, par. out

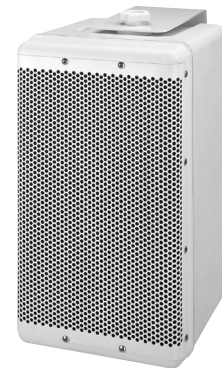

PAB-6WP/WS

Order No. 0253560



Weatherproof high-performance PA speaker system, 100 W

- Compact 2-way bass-reflex system in an ABS cabinet
- 100 V or 8 Ω operation, selectable
- 16 cm bass speaker with coated carbon fibre cone
- 30 mm dome tweeter with horn front attachment
- Front grille with water-repellent gauze
- Recessed connection terminal with cover plate and high-strength cable gland
- Metal parts and wall bracket made of stainless steel
- Ball-proof according to DIN 18032, Part 3

Model	PAB-6WP/WS
Total power rating	180 W
Power rating (RMS)	100/50/25 W
Frequency range	42-19,000 Hz
SPL	90 dB/W/m
Protection class	IP45
Admiss. ambient temp.	-10 °C to +40 °C
Dimensions	200 x 370 x 240 mm
Weight	7.1 kg
Inputs	screw terminal



PAB-68/SW

Order No. 0131930



PAB-68/WS

Order No. 0131940



Pair of high-quality PA speakers, 8 Ω

- 2-way speaker system in an ABS cabinet which is both functional and at the same time of an attractive appearance, bass-reflex
- Polypropylene bass speaker and dome tweeter with horn front attachment (waveguide)
- High-quality crossover networks with perfect long-term stability, e.g. due to consistently applying film capacitors

Model	PAB-68/SW	PAB-68/WS
Total power rating	70 W	70 W
Power rating (RMS)	40 W	40 W
Frequency range	55-22,000 Hz	55-22,000 Hz
SPL	90 dB/W/m	90 dB/W/m
Dimensions	210 x 350 x 200 mm	210 x 350 x 200 mm
Weight	3.9 kg	3.9 kg
Inputs	speaker screw terminal	speaker screw terminal

- Really fast and brilliant sound of high efficiency and high dynamic range, particularly suitable for PA applications of modern music at higher volume levels
- LED at the front for indicating the level
- Supplied with wall bracket



MKS-8PRO

Order No. 0131770



Pair of high-performance PA speakers, 100 W each speaker system

- 2-way speaker systems with ABS cabinet (bass-reflex) of modern design
- 20 cm bass speaker and dome tweeter
- Very extended frequency response and high volume capability
- Supplied with mounting brackets for wall mounting

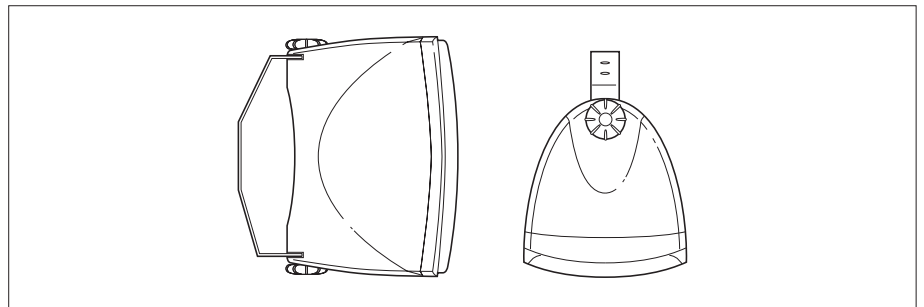

Model	MKS-8PRO
Total power rating	180 W
Power rating (RMS)	100 W
Frequency range	40-21,000 Hz
SPL	91 dB/W/m
Dimensions	265 x 374 x 285 mm
Weight	5.7 kg
Inputs	speaker screw terminal

MKS-88/SW

Order No. 0131150



MKS-64/SW

Order No. 0131130



MKS-64/WS

Order No. 0131140



MKS-34/SW

Order No. 0131110



MKS-34/WS

Order No. 0131120



Pairs of 2-way speaker systems

- MKS-88... in 8 Ω, MKS-64... and MKS-34... in 4 Ω
- Dome tweeter
- Excellent sound quality
- Black (SW) or white (WS) plastic cabinet
- Pivoting mounting bracket
- Bevelled shape of cabinets also allows mounting in corners



Model	MKS-88/SW	MKS-64/SW	MKS-64/WS	MKS-34/SW	MKS-34/WS
Total power rating	125 W	90 W	90 W	45 W	45 W
Power rating (RMS)	85 W	60 W	60 W	30 W	30 W
Frequency range	40-20,000 Hz	60-20,000 Hz	60-20,000 Hz	80-20,000 Hz	80-20,000 Hz
SPL	89 dB/W/m	89 dB/W/m	89 dB/W/m	87 dB/W/m	87 dB/W/m
Dimensions	270 x 370 x 220 mm	215 x 290 x 172 mm	215 x 290 x 172 mm	130 x 192 x 115 mm	130 x 192 x 115 mm
Weight	5.4 kg	3.4 kg	3.4 kg	1.3 kg	1.3 kg
Inputs	spring-load, speaker term.	spring-load, speaker term.	spring-load, speaker term.	spring-load, speaker term.	spring-load, speaker term.

Speakers

Speaker Systems

WALL-05SET/WS

Order No. 0130132



Active 2-way stereo speaker system, 2 x 30 W

- Set consists of one active and one passive speaker system. Connection of the passive system to the active system via screw terminal strip
- Active speaker system with integrated 2-channel amplifier
- Stereo RCA input or balanced input L/R via screw terminal strip
- Volume control and 2-way tone control
- Auto standby
- 13 cm (5") bass speaker system and dome tweeter
- Mounting bracket for pivoting and tilting

Model	WALL-05SET/WS
Total output power	2 x 50 W
Power rating (RMS)	2 x 30 W
Frequency range	80-20,000 Hz
Input signal	500 mV/20 kΩ (unbal.) 660 mV/40 kΩ (bal.)
SPL	89 dB/W/m
Power supply	~ 230 V/50 Hz/100 VA
Dimensions	163 x 252 x 203 mm (with bracket)
Weight	5.5 kg (pair)
Inputs	1 x RCA L/R (unbalanced) 1 x terminal L/R (balanced) spring-load. speaker term. (passive speaker system) spring-load. speaker term.



WALL-06SET/WS

Order No. 0130131



Active 2-way stereo speaker system, 2 x 30 W

- Set consists of one active and one passive speaker system. Connection of the passive system to the active system via screw terminal strip
- Active speaker system with integr. 2-channel amplifier
- Stereo RCA input or balanced input L/R via screw terminal strip
- Volume control and 2-way tone control
- Auto standby
- Built-in power supply with 3-pin IEC jack
- 16 cm (6") bass speaker system and dome tweeter

Model	WALL-06SET/WS
Total output power	2 x 50 W
Power rating (RMS)	2 x 30 W
Frequency range	70-20,000 Hz
Input signal	890 mV/20 kΩ (unbal.) 1,600 mV/40 kΩ (bal.)
SPL	90 dB/W/m
Power supply	~ 230V/50 Hz/140VA
Dimensions	196 x 303 x 250 mm (with bracket)
Weight	8 kg (pair)
Inputs	1 x RCA L/R (unbalanced) 1 x terminal L/R (balanced) spring-load. speaker term. (passive speaker system) spring-load. speaker term.



- Mounting bracket for pivoting and tilting

MKA-50SET/SW

Order No. 0132350



MKA-50SET/WS

Order No. 0132360



Active 2-way stereo speaker systems, 2 x 20 W

- Set consists of an active and a passive speaker system. Connection of the passive system to the active system via spring-loaded speaker terminals
- Active speaker system with integrated 2-channel amplifier and power supply
- Speakers with magnetic shielding
- Auto-standby function
- Volume control and 2-way tone control

Model	MKA-50SET/SW, MKA-50SET/WS
Total output power	2 x 40 W
Power rating (RMS)	2 x 20 W
Frequency range	60-20,000 Hz
Input signal	420 mV/24 kΩ
SPL	89 dB/W/m
Power supply	~ 230 V/50 Hz/110 VA
Dimensions	180 x 250 x 160 mm
Weight	5.9 kg (pair)
Inputs	1 x RCA L/R (active speak. system only) 1 x 3.5 mm jack screw terminals (both speaker systems)



SOUND-4BT/WS

Order No. 0257060



Active 2-way stereo speaker system, with

Bluetooth receiver, 2 x 30 W.

- Set consists of an active and a passive bass-reflex speaker system. Connection of the passive system to the active system via spring-loaded speaker terminals
- Bluetooth receiver V4.0 with APTX
- Active speaker system with integrated 2-channel class D amplifier
- Stereo RCA and 3.5 mm jack input, optical digital input (Toslink), mono sub out via RCA jack
- Supplied with remote control
- 10 cm (4") bass speaker and 25 mm (1") dome tweeter
- Excellent sound characteristics with linear adjustment

Model	SOUND-4BT/WS
Power rating (RMS)	2 x 30 W
Frequency range	45-20,000 Hz
Input signal	Bluetooth 500 mV/10 kΩ
SPL	85 dB/W/m (each speaker system)
Power supply	~ 230 V/50 Hz/170 VA
Dimensions	140 x 215 x 170 mm
Weight	5.2 kg (pair)
Inputs	1 x RCA L/R 1 x 3.5 mm stereo jack 1 x Toslink, optical digital input spring-load. speaker term. for passive sp. system



- High-gloss lacquered MDF wooden cabinet of high quality

ETS-120SL/WS

Order No. 0163450



Pair of line array design speakers, 4 Ω, in super slimline extruded aluminium cabinets.

- Elegant slimline design
- Cross-sectional area not much bigger than a 1 Euro coin
- New type of speaker systems with magnetostatic drive and flat cone speakers
- Very wide bandwidth reproduction with an excellent sound quality
- High transmission range due to line array system
- Connection via screw terminal
- Fine-meshed front grille with fleece lining
- Supplied with mounting brackets and connection cables

Model	ETS-120SL/WS
Total power rating	80 W
Power rating (RMS)	40 W
Impedance	4 Ω
Frequency range	120-20,000 Hz
SPL	88 dB/W/m
Beam angle	H: 160°/V: 40°
Dimensions	36 x 1,210 x 22 mm
Weight	0.95 kg
Inputs	screw terminal



SOUND-100SUB

Order No. 0250730



Active subwoofer system, 120 W

- Active subwoofer as an addition to the active SOUND speaker systems, but also to any other compact speaker for hi-fi or home cinema applications and home recording
- Amplifier features variable input sensitivity, a phase switch, an automatic switch-on system which can additionally be activated as well as an adjustable crossover frequency (50-150 Hz)
- High-quality bass-reflex MDF cabinet (black wood veneer look)
- 25 cm (10") bass speaker
- Volume control for the subwoofer
- Inputs via 1 x RCA L/R, RCA LFE or screw terminals for high-level L/R

Model	SOUND-100SUB
Power rating (RMS)	120 W
Frequency range	35-100 Hz
Input signal	150 mV/24 kΩ (RCA L/R) 55 mV/16 kΩ (RCA mono) 2.3 V/440 Ω (high IN)
SPL	88 dB/W/m
Power supply	~ 230 V/50 Hz/240 VA
Dimensions	330 x 360 x 360 mm
Weight	13 kg
Inputs	1 x RCA (L/R), unbal., IN 1 x RCA (mono), unbal., IN 1 x screw terminal (stereo), high-level IN
Outputs	1 x screw terminals (stereo), high-level out

- Additional outputs for mid-high range speakers, thus well-suited for connection to already existing speaker cables



ESUB-8F/WS

Order No. 0259300



Active subwoofer system, 50 W

- Compact active subwoofer of elegant design as an addition to compact speakers for hi-fi, PA, home cinema and home recording
- Beside volume control, a phase switch and an automatic switch-on, the amplifier also features an adjustable crossover frequency (50-250 Hz)
- High-quality bass-reflex MDF cabinet, high-gloss white
- 20 cm (8") bass speaker
- Inputs via 1 x RCA L/R or screw terminals for high-level L/R
- Parallel line out RCA L/R
- Additional outputs high-level L/R for mid-high range speakers. Thus, well suited for connection to already existing speaker lines
- White fabric front cover

Model	ESUB-8F/WS
Total output power	90 W
Power rating (RMS)	50 W
Frequency range	30-250 Hz
Input signal	185 mV/9 kΩ (RCA L/R) 4 V/480 Ω (high IN)
SPL	87 dB/W/m
Power supply	~ 230 V/50 Hz/152 VA
Dimensions	300 x 330 x 340 mm
Weight	9.8 kg
Inputs	1 x RCA (L/R), unbal., IN 1 x screw terminals (stereo), high-level IN
Outputs	1 x RCA (L/R) 1 x screw terminals (stereo), high-level OUT



Speakers

PA Systems

MOVE-12PMK2

Order No. 1000227



Professional PA speaker system, 350 W, 8 Ω

- Compact professional full range bass-reflex system
- Cabinet made of birch plywood
- 30 cm (128", FaisalPro 12PR300) bass speaker
- 25 mm (1", 44 mm voice coil, Celestion CDX1-1747) horn tweeter, can be turned by 90°
- Switchable between passive operation and bi-amp active operation
- Neutral sound tuning
- 'Catch & Carry' carrying handle
- M8 threaded inserts for suspended installation
- 2 x NEUTRIK SPEAKON terminal, in/out

Model	MOVE-12PMK2
Total power rating	700 W
Power rating (RMS)	350 W
Impedance	8 Ω
SPL	98 dB/W/m
Dimensions	350 x 620 x 385 mm
Weight	16.4 kg
Inputs	1 x NEUTRIK SPEAKON
Outputs	1 x NEUTRIK SPEAKON par.out

- Stand sleeve, robust front grille
- Ball-proof acc. to DIN 18032, Part 3



MOVE-10PMK2

Order No. 1000226



Professional PA speaker system, 350 W, 8 Ω

- Compact professional full range bass-reflex system
- Cabinet made of birch plywood
- 25 cm (10", FaisalPro 10PR300) bass speaker
- 25 mm (1", 44 mm voice coil, Celestion CDX1-1747) horn tweeter, can be turned by 90°
- Switchable between passive operation and bi-amp active operation
- Neutral sound tuning
- 'Catch & Carry' carrying handle
- M8 threaded inserts for suspended installation
- 2 x NEUTRIK SPEAKON terminal, in/out

Model	MOVE-10PMK2
Total power rating	700 W
Power rating (RMS)	350 W
Impedance	8 Ω
Frequency range	55-20,000 Hz
SPL	96 dB/W/m
Dimensions	320 x 545 x 350 mm
Weight	13.9 kg
Inputs	1 x NEUTRIK SPEAKON
Outputs	1 x NEUTRIK SPEAKON par.out

- Stand sleeve, robust front grille
- Ball-proof acc. to DIN 18032, Part 3



MOVE-08PMK2

Order No. 1000225



Professional PA speaker system, 250 W, 8 Ω

- Compact professional full range bass-reflex system
- Cabinet made of birch plywood
- 20 cm (8", FaisalPro 8PR200) bass speaker
- 25 mm (1", 44 mm voice coil, Celestion CDX1-1747) horn tweeter, can be turned by 90°
- Switchable between passive operation and bi-amp active operation
- Neutral sound tuning
- 'Catch & Carry' carrying handle
- M8 threaded inserts for suspended installation
- 2 x NEUTRIK SPEAKON terminal, in/out

Model	MOVE-08PMK2
Total power rating	500 W
Power rating (RMS)	250 W
Impedance	8 Ω
Frequency range	65-20,000 Hz
SPL	95 dB/W/m
Dimensions	290 x 490 x 315 mm
Weight	12.6 kg
Inputs	1 x NEUTRIK SPEAKON
Outputs	1 x NEUTRIK SPEAKON par.out

- Stand sleeve, robust front grille
- Ball-proof acc. to DIN 18032, Part 3



MOVE-12/BAG

Order No. 1000210

MOVE-10/BAG

Order No. 1000207

MOVE-08/BAG

Order No. 1000204

Protective covers for speaker systems

MOVE-12/BAG for PA speaker system MOVE-12PMK2

MOVE-10/BAG for PA speaker system MOVE-10PMK2

MOVE-08/BAG for PA speaker system MOVE-08PMK2

- Outer material made of robust, black synthetic cloth
- Openings for handles



PAB-308/SW

Order No. 0254290

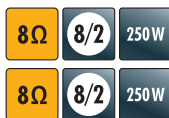

PAB-308/WS

Order No. 0254300

Universal PA speaker systems, 125 W, 8 Ω

- Compact 8/2 full range bass-reflex system
- 20 cm (8") bass speaker, 25 mm (1") horn tweeter
- Tweeter protection circuit
- High-quality MDF wooden cabinet in black (SW) or white (WS), with protective metal grille
- 4 x M8 threaded inserts for suspended installation

Model	PAB-308/SW, PAB-308/WS
Total power rating	250 W
Power rating (RMS)	125 W
Frequency range	60-20,000 Hz
SPL	93 dB/W/m
Dimensions	258 x 410 x 247 mm
Weight	7.5 kg
Inputs	1 x NEUTRIK SPEAKON
Outputs	1 x NEUTRIK SPEAKON par. out

- Supplied with mounting bracket and integrated stand sleeve
- NEUTRIK SPEAKON terminal



PAB-306/SW

Order No. 0254270

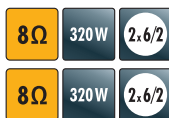

PAB-306/WS

Order No. 0254280

Universal PA speaker systems, 160 W, 8 Ω

- Closed 2-way system
- 2 x 16 cm (6.5") bass speaker, 25 mm (1") horn tweeter
- Tweeter protection circuit
- High-quality MDF wooden cabinets in black (SW) or white (WS), with protective metal grille

Model	PAB-306/SW, PAB-306/WS
Total power rating	320 W
Power rating (RMS)	160 W
Frequency range	65-20,000 Hz
SPL	93 dB/W/m
Dimensions	212 x 565 x 190 mm
Weight	9.5 kg
Inputs	1 x NEUTRIK SPEAKON
Outputs	1 x NEUTRIK SPEAKON, par. out

- 4 x M8 threaded inserts for suspended installation
- Supplied with mounting bracket and integrated stand sleeve
- NEUTRIK SPEAKON terminal

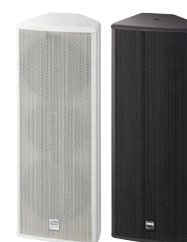

CLUB-1TOP

Order No. 0252490



Pair of professional PA speaker systems, 2 x 100 W/8 Ω

- 16 cm high-performance bass-midrange speaker with carbon fibre cone
- Waveguide dome tweeter
- NEUTRIK SPEAKON IN/OUT for an easy parallel connection
- High-quality lacquered MDF cabinet, full front grille with acoustic foam

Model	CLUB-1TOP
Total power rating	160 W
Power rating (RMS)	100 W
Frequency range	55-21,000 Hz
SPL	90 dB/W/m
Dimensions	210 x 300 x 260 mm
Weight	6 kg
Inputs	1 x NEUTRIK SPEAKON
Outputs	1 x NEUTRIK SPEAKON

- 6 x M8 threaded insert, 1 x standard stand sleeve



CLUB-1SUB

Order No. 0252480



Professional subwoofer, 600 W/8 Ω or 2 Ω or 2 x 300 W/4 Ω

- 4 x 20 cm (8") top-class woofer
- Variable impedance concept (switchable between 1 x 8 Ω and 2 x 4 Ω, for parallel connection in the 2 x 4 Ω position as 1 x 2 Ω)
- High-quality lacquered MDF cabinet, full front grille with acoustic foam
- An amplifier with integrated or external active crossover network is required for operation

Model	CLUB-1SUB
Total power rating	1,200 W
Power rating (RMS)	600 W
Frequency range	45-250 Hz
SPL	96 dB/W/m
Dimensions	300 x 880 x 440 mm
Weight	29.5 kg
Inputs	1 x or 2 x NEUTRIK SPEAKON, switchable



SUB-10

Order No. 0259875



Passive subwoofer, 500 W/8 Ω

- Band-pass subwoofer with double ventilation
- 1 x 25 cm (10") top-class woofer
- Slimline and compact design for upright and horizontal setup
- High-quality lacquered cabinet made of plywood, front grille with inner lining
- Integrated crossover network (low-pass) with crossover frequency at 200 Hz

Model	SUB-10
Total power rating	500 W
Power rating (RMS)	250 W
Frequency range	40-200 Hz
SPL	92 dB/W/m
Dimensions	300 x 610 x 410 mm
Weight	19.84 kg
Inputs	1 x NEUTRIK SPEAKON, speaker terminals



Speakers PA Systems

EUL-2/SW

Order No. 0174450



PA speaker system, 100 V transmission technology

- High-quality cabinet with durable PU coating
- 20 cm (2 x 8") double bass speaker of high power capability and a dyn. 25 mm (1") horn tweeter
- Well-balanced and dynamic sound for speech and music applications
- SPEAKON connection, rotary switch for power selection, stand sleeve
- A subwoofer support is useful for bass reproductions of high requirements (e.g. with EUL-2SUB/SW)
- This speaker can be integrated into any existing or new 100 V system by simply connecting it in parallel, as long as the amplifier features the respective power reserves

Matching adapter piece for speaker system PAST-28/SW is available at option.

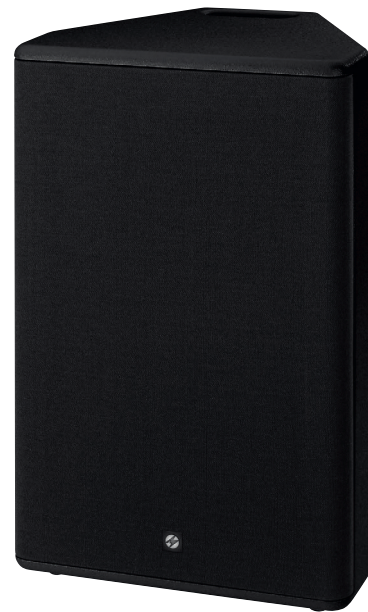
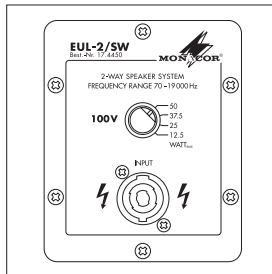

Model	EUL-2/SW
Power rating (RMS)	50/37.5/25/12.5 W
Frequency range	70-19,000 Hz
SPL	95 dB/W/m
Dimensions	320 x 485 x 250 mm
Weight	8.7 kg
Inputs	1 x SPEAKON

EUL-2SUB/SW

Order No. 0174460



Subwoofer in 100 V line technique

- High-quality cabinet with durable PU coating
- 30 cm (12") bass speaker for a deep and dynamic bass reproduction
- SPEAKON connections (input and sat out/par. out)
- The design and high efficiency perfectly match the EUL-2/SW, but it is also suitable as an addition to many other 100 V systems
- Built-in crossover network (low-pass) allows for an almost unlocatable bass
- Please ensure that the 100 V amplifier provides sufficient power capabilities!

Matching adapter piece for speaker system PAST-28/SW is available at option.

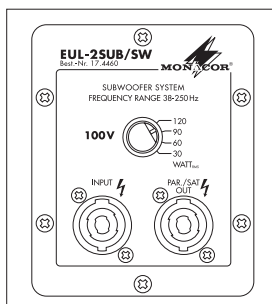

Model	EUL-2SUB/SW
Power rating (RMS)	120/90/60/30 W
Frequency range	38-250 Hz
SPL	95 dB/W/m
Dimensions	420 x 430 x 445 mm
Weight	18.2 kg
Inputs	1 x SPEAKON IN
Outputs	1 x SPEAKON par. out/sat out

IT-130AK

Order No. 1000666



Active weatherproof horn speaker

- Weatherproof and IP66 tested
- Integrated 30 W amplifier
- Volume control
- Easy replaceable connection cables via screw terminals
- Mobile application possible due to voltage supply of 12-24 V=/2.5 A

Model	IT-130AK
Total output power	30 W
Frequency range	250-16,000 Hz
Input signal	750 mV/5 kΩ (line)
SPL	109 dB/W/m
Admiss. ambient temp.	-20 °C to +50 °C
Power supply	12-24 V=/2.5 A
Dimensions	290 x 215 x 260 mm
Weight	1.5 kg

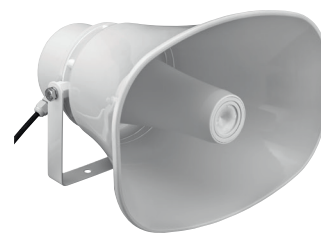

IT-400TW

Order No. 0162580



Weatherproof horn speaker (music horn), 2-way technology

- 100 V transmission technology with very high tapping power
- Weatherproof and IP66 certified
- Very wideband sound with a distinct bass volume, even at very high volume levels
- 16 cm bass-midrange speaker and 25 mm (1") horn
- Robust plastic housing
- Supplied with mounting bracket and screws made of stainless steel

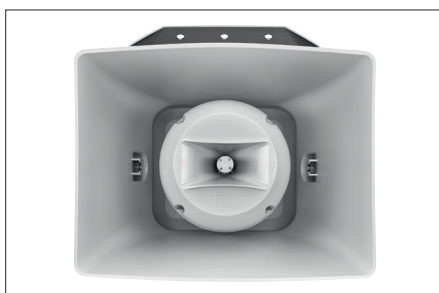

Model	IT-400TW
Power rating (RMS)	60/30/15/7.5 W
Frequency range	100-20,000 Hz
SPL	98 dB/W/m
Beam angle	H: 100°/V: 60°
Admiss. ambient temp.	-20 °C to +50 °C
Dimensions	420 x 335 x 400 mm
Weight	6.68 kg

IT-400RTW

Order No. 0163350



Weatherproof horn speaker (music horn), 2-way technology

- 100 V line technique with very high tapping power
- Weatherproof and IP66 certified
- Very wideband sound with a distinct bass volume, even at very high volume levels
- 16 cm bass-midrange speaker and 25 mm (1") horn
- Suitable for indoor and outdoor applications
- Due to round design, consistent radiation pattern in the required area, e.g. ceiling suspension in halls
- Robust plastic housing
- Supplied with mounting bracket and screws made of stainless steel

Model	IT-400RTW
Power rating (RMS)	60/30/15/7.5 W
Frequency range	120-20,000 Hz
SPL	101 dB/W/m
Beam angle	H: 90°/V: 90°
Admiss. ambient temp.	-20 °C to +50 °C
Dimensions	∅ 400 mm x 420 mm
Weight	6.5 kg



Speakers

Music Horns

IT-350/EN

Order No. 0163950



Weatherproof horn speaker (music horn), 2-way technology and EN 54-24 certification

- 100 V transmission technology with 4 power taps: 30/15/7.5/3.75 W
- Weatherproof and IP66 certified
- High-quality music reproduction
- 16 cm bass-midrange speaker and 25 mm (1") horn
- Robust light grey ABS plastic housing
- Supplied with mounting bracket and stainless steel screws

Model	IT-350/EN
Total power rating	30 W
Power rating (RMS)	30/15/7.5/3.75 W
Frequency range	100-20,000 Hz
SPL	101 dB/W/m
Beam angle	H: 100°/V: 60°
Admiss. ambient temp.	-20 °C to +90 °C
Dimensions	370 x 250 x 330 mm
Weight	4.5 kg

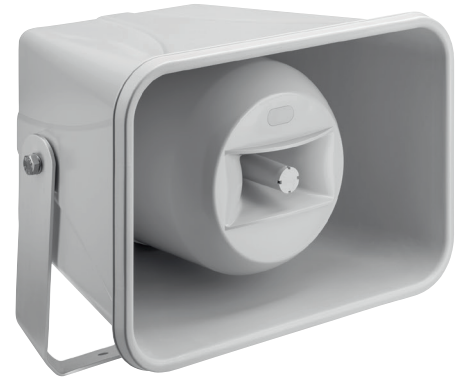

IT-250TW

Order No. 0163190



Weatherproof horn speaker (music horn), 2-way technology

- 100 V transmission technology or 8 Ω operation
- IP66 certified
- High-performance music horn at an attractive price
- 16 cm bass-midrange speaker and 25 mm (1") horn
- ABS plastic housing
- Supplied with mounting bracket

Model	IT-250TW
Power rating (RMS)	50/25/12.5/9/4.5/3.5 W (100 V)
	50 W (8 Ω)
Frequency range	150-15,000 Hz
SPL	97 dB/W/m
Beam angle	H: 100°/V: 60°
Admiss. ambient temp.	-20 °C to +50 °C
Dimensions	370 x 270 x 305 mm
Weight	4.1 kg

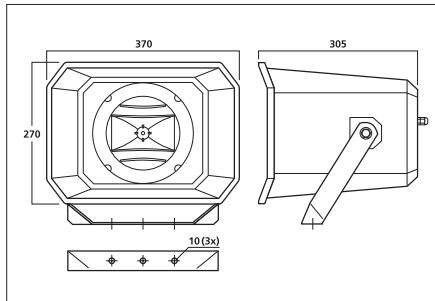

IT-100TW

Order No. 0162570



Weatherproof horn speaker (music horn), 2-way technology

- 100 V transmission technology
- Weatherproof and IP66 certified
- Wideband sound with a distinct bass volume
- 13 cm bass-midrange speaker and 25 mm (1") horn
- Suitable for indoor and outdoor applications
- Robust plastic housing of very low resonance
- Supplied with stainless steel mounting bracket
- 4 power taps, connection via screw terminals

Model	IT-100TW
Power rating (RMS)	30/15/7.5/3.75 W
Frequency range	100-20,000 Hz
SPL	99 dB/W/m
Beam angle	H: 110°/V: 60°
Admiss. ambient temp.	-20 °C to +50 °C
Dimensions	310 x 215 x 330 mm
Weight	4.42 kg



IT-100RTW

Order No. 0163340



Weatherproof horn speaker (music horn), 2-way technology

- 100 V transmission technology with very high tapping power
- Weatherproof and IP66 certified
- Very wideband sound with a distinct bass volume, even at very high volume levels
- 13 cm bass-midrange speaker and 25 mm (1") horn
- Due to round design, consistent radiation pattern in the required area, e.g. ceiling suspension in halls
- Robust plastic housing
- Supplied with mounting bracket and screws made of stainless steel

Model	IT-100RTW
Power rating (RMS)	30/15/7.5/3.75 W
Frequency range	150-20,000 Hz
SPL	101 dB/W/m
Beam angle	H: 90°/V: 90°
Admiss. ambient temp.	-20 °C to +50 °C
Dimensions	Ø 300 mm x 360 mm
Weight	4.4 kg



IT-60

Order No. 0162990



Weatherproof horn speaker, with high power capability.

- 100 V transmission technology
- Weatherproof and IP66 tested
- Protected against powerful water jets
- Suitable for general indoor and outdoor applications
- Light grey ABS housing (self-extinguishing, complies with standard UL 94V-0)
- Supplied with stainless steel mounting bracket
- Integrated ceramic connection terminal with thermal fuse
- 4 power taps

Model	IT-60
Power rating (RMS)	60/30/15/7.5 W
Frequency range	230-9,000 Hz
SPL	110 dB/W/m
Beam angle	H: 80°/V: 30°
Admiss. ambient temp.	-20 °C to +50 °C
Dimensions	Ø 305 mm x 385 mm
Weight	4 kg



IT-40

Order No. 0161360



Weatherproof horn speaker

- 100 V transmission technology
- Weatherproof and IP66 tested
- Protected against powerful water jets
- Suitable for general indoor and outdoor applications
- Robust plastic housing
- Mounting bracket and screws made of stainless steel
- 5-step power selector switch

Model	IT-40
Power rating (RMS)	40/30/20/10/5 W
Frequency range	180-7,000 Hz
SPL	113 dB/W/m
Beam angle	H: 100°/V: 45°
Admiss. ambient temp.	-20 °C to +50 °C
Dimensions	400 x 200 x 420 mm
Weight	3.66 kg



Speakers

Horn Speakers

IT-35

Order No. 0160870



Weatherproof horn speaker

- 100 V transmission technology
- Weatherproof and IP66 tested
- Protected against powerful water jets
- Suitable for general indoor and outdoor applications
- Robust plastic housing
- Mounting bracket and screws made of stainless steel
- 5-step power selector switch

Model	IT-35
Power rating (RMS)	25/20/15/10/5 W
Frequency range	250-10,000 Hz
SPL	108 dB/W/m
Beam angle	H: 110°/V: 52°
Admiss. ambient temp.	-20 °C to +50 °C
Dimensions	300 x 180 x 315 mm
Weight	2.4 kg



IT-33

Order No. 0162190



Weatherproof horn speaker

- 100 V transmission technology
- IP54 tested
- White ABS housing (self-extinguishing, complies with standard UL 94V-0)
- Particularly high power capability in relation to its size
- Suitable for general indoor and outdoor applications
- Integrated high-pass filter for optimising the sound and stability

Model	IT-33
Power rating (RMS)	25/12.5/6.25 W
Frequency range	500-13,000 Hz
SPL	107 dB/W/m
Beam angle	H: 90°/V: 90°
Admiss. ambient temp.	-20 °C to +50 °C
Dimensions	Ø 130 mm x 175 mm
Weight	1.8 kg



IT-32EN

Order No. 0160020



IT-15EN

Order No. 0160230



Weatherproof horn speakers, with EN 54-24 certification.

- 100 V transmission technology
- IP66 tested
- Light grey ABS housing (self-extinguishing, complies with the standard UL 94V-0)
- Cable inlet via high-strength cable gland

Model	IT-32EN	IT-15EN
Total power rating	30 W	15 W
Power rating (RMS)	30/15/7.5 W	15/7.5/3.75 W
Frequency range	350-10,000 Hz	350-10,000 Hz
SPL	110 dB/W/m	110 dB/W/m
Beam angle	H: 110°/V: 55°	H: 110°/V: 55°
Admiss. ambient temp.	-25 °C to +70 °C	-25 °C to +70 °C
Dimensions	180 x 120 x 230 mm	180 x 120 x 230 mm
Weight	2.1 kg	2.1 kg



IT-30

Order No. 0160670



Weatherproof horn speaker

- 100 V transmission technology
- Weatherproof and IP66 tested
- Protected against powerful water jets
- Suitable for general indoor and outdoor applications
- Aluminium housing
- Mounting bracket and screws made of stainless steel
- 4-step power selector switch

Model	IT-30
Power rating (RMS)	20/15/10/5 W
Frequency range	250-10,000 Hz
SPL	108 dB/W/m
Beam angle	H: 80°/V: 80°
Admiss. ambient temp.	-20 °C to +50 °C
Dimensions	Ø 265 mm x 310 mm
Weight	2.25 kg



IT-20

Order No. 0160660



Weatherproof horn speaker

- 100 V transmission technology
- Weatherproof and IP66 tested
- Protected against powerful water jets
- Suitable for general indoor and outdoor applications
- Robust plastic housing
- Mounting bracket and screws made of stainless steel
- 4-step power selector switch

Model	IT-20
Power rating (RMS)	15/10/5/2.5 W
Frequency range	275-7,000 Hz
SPL	106 dB/W/m
Beam angle	H: 100°/V: 50°
Admiss. ambient temp.	-20 °C to +50 °C
Dimensions	250 x 145 x 300 mm
Weight	1.88 kg



IT-130

Order No. 0161710



Weatherproof horn speaker

- 100 V transmission technology
- Weatherproof and IP66 tested
- Protected against powerful water jets
- Power selector switch
- For open-air events, industrial use, in workshops

Model	IT-130
Power rating (RMS)	30/15/10/5/3/1 W
Frequency range	250-16,000 Hz
SPL	109 dB/W/m
Admiss. ambient temp.	-20 °C to +50 °C
Dimensions	290 x 215 x 260 mm
Weight	1.6 kg



IT-115

Order No. 0161700



Weatherproof horn speaker

- 100 V transmission technology
- Weatherproof and IP66 tested
- Protected against powerful water jets
- Power selector switch
- For open-air events, industrial use, in workshops

Model	IT-115
Power rating (RMS)	15/10/5/3/1 W
Frequency range	280-12,500 Hz
SPL	108 dB/W/m
Admiss. ambient temp.	-20 °C to +50 °C
Dimensions	225 x 160 x 235 mm
Weight	1.3 kg



IT-110

Order No. 0161690



Horn speaker

- 100 V transmission technology
- Weatherproof and IP66 tested
- Protected against powerful water jets
- Power selector switch
- For open-air events, industrial use, in workshops

Model	IT-110
Power rating (RMS)	10/5/3/1 W
Frequency range	315-12,500 Hz
SPL	105 dB/W/m
Admiss. ambient temp.	-20 °C to +50 °C
Dimensions	175 x 130 x 185 mm
Weight	1.1 kg



NR-254KS

Order No. 0162480



Weatherproof horn speaker

- 4 Ω speaker system
- IP66 tested, protected against powerful water jets
- Especially suitable for voice transmissions
- Robust plastic housing of compact size
- 2-wire connection cable, length: 60 cm
- Mounting bracket and screws made of stainless steel

Model	NR-254KS
Total power rating	25 W
Power rating (RMS)	12 W
Frequency range	800-8,000 Hz
SPL	107 dB/W/m
Beam angle	H: 90°/V: 90°
Admiss. ambient temp.	-20 °C to +50 °C
Dimensions	106 x 106 x 88 mm
Weight	1.08 kg



Speakers

Horn Speakers

NR-60KS

Order No. 0163010



Weatherproof horn speaker, with high power capability.

- 16 Ω speaker system
- IP66 tested, protected against powerful water jets
- Suitable for general indoor and outdoor applications
- Robust light grey plastic housing
- Aluminium mounting bracket

Model	NR-60KS
Total power rating	60 W
Power rating (RMS)	30 W
Frequency range	340-10,000 Hz
SPL	103 dB/W/m
Admiss. ambient temp.	-20 °C to +50 °C
Dimensions	Ø 146 mm x 160 mm
Weight	2 kg



NR-40KS

Order No. 0161370



Weatherproof horn speaker

- 16 Ω speaker system
- IP66 tested, protected against powerful water jets
- Suitable for general indoor and outdoor applications
- Robust plastic housing
- Mounting bracket and screws made of stainless steel

Model	NR-40KS
Total power rating	60 W
Power rating (RMS)	30 W
Frequency range	180-7,000 Hz
SPL	113 dB/W/m
Beam angle	H: 110°/V: 45°
Admiss. ambient temp.	-20 °C to +50 °C
Dimensions	400 x 200 x 385 mm
Weight	3 kg



NR-35KS

Order No. 0160250



Horn speaker

- Moisture-proof
- 8 Ω speaker system

Model	NR-35KS
Total power rating	40 W
Power rating (RMS)	20 W
Frequency range	300-12,000 Hz
SPL	107 dB/W/m
Beam angle	H: 100°/V: 50°
Admiss. ambient temp.	0-40 °C
Dimensions	280 x 170 x 215 mm
Weight	1.4 kg



NR-33KS

Order No. 0160650



Weatherproof horn speaker

- IP66 tested, protected against powerful water jets
- 8 Ω speaker system
- Suitable for general indoor and outdoor applications
- Robust plastic housing
- Mounting bracket and screws made of stainless steel

Model	NR-33KS
Total power rating	25 W
Power rating (RMS)	12 W
Frequency range	275-7,000 Hz
SPL	106 dB/W/m
Beam angle	H: 100°/V: 50°
Admiss. ambient temp.	-20 °C to +50 °C
Dimensions	250 x 145 x 272 mm
Weight	1.5 kg



UHC-30

Order No. 0160640



Weatherproof horn speaker

- 8 Ω speaker system
- IP66 tested, protected against powerful water jets
- For open-air events, industrial use, in workshops
- Mounting bracket and screws made of stainless steel

Model	UHC-30
Total power rating	40 W
Power rating (RMS)	20 W
Frequency range	230-10,000 Hz
SPL	108 dB/W/m
Beam angle	H: 75°/V: 75°
Admiss. ambient temp.	-20 °C to +50 °C
Dimensions	Ø 310 mm x 285 mm
Weight	1.89 kg



NR-25KS

Order No. 0160240



Horn speaker

- Moisture-proof
- 8 Ω speaker system

Model	NR-25KS
Total power rating	30 W
Power rating (RMS)	15 W
Frequency range	350-8,000 Hz
SPL	102 dB/W/m
Admiss. ambient temp.	0-40 °C
Dimensions	200 x 140 x 235 mm
Weight	1.1 kg



NR-24KS

Order No. 0161020



Horn speaker

- Moisture-proof
- 8 Ω speaker system

Model	NR-24KS
Total power rating	30 W
Power rating (RMS)	15 W
Frequency range	400-7,000 Hz
SPL	105 dB/W/m
Admiss. ambient temp.	0-40 °C
Dimensions	200 x 150 x 235 mm
Weight	0.9 kg



NR-22KS

Order No. 0161010



Horn speaker

- Moisture-proof
- 8 Ω speaker system

Model	NR-22KS
Total power rating	15 W
Power rating (RMS)	8 W
Frequency range	600-7,000 Hz
SPL	104 dB/W/m
Admiss. ambient temp.	0-40 °C
Dimensions	Ø 135 mm x 165 mm
Weight	0.427 kg



Speakers

Horn Speakers

NR-20KS

Order No. 0161000



Horn speaker

- Moisture-proof
- 8 Ω speaker system

Model	NR-20KS
Total power rating	10 W
Power rating (RMS)	5 W
Frequency range	800-7,000 Hz
SPL	103 dB/W/m
Admiss. ambient temp.	0-40 °C
Dimensions	Ø 90 mm x 105 mm
Weight	0.39 kg



NR-15KS

Order No. 0160220



Horn speaker

- Aluminium version
- Moisture-proof
- 8 Ω speaker system

Model	NR-15KS
Total power rating	15 W
Power rating (RMS)	8 W
Frequency range	350-12,000 Hz
SPL	100 dB/W/m
Admiss. ambient temp.	0-40 °C
Dimensions	210 x 150 x 195 mm
Weight	0.923 kg



NR-12KS

Order No. 0160210



Horn speaker

- Aluminium version
- For open-air events, industrial use, in workshops
- Moisture-proof
- 8 Ω speaker system

Model	NR-12KS
Total power rating	12 W
Power rating (RMS)	6 W
Frequency range	350-12,000 Hz
SPL	100 dB/W/m
Admiss. ambient temp.	0-40 °C
Dimensions	Ø 160 mm x 155 mm
Weight	0.85 kg



NR-18KS

Order No. 0160990



Horn speaker

- Moisture-proof
- 8 Ω speaker system

Model	NR-18KS
Total power rating	10 W
Power rating (RMS)	5 W
Frequency range	1,200-7,000 Hz
SPL	98 dB/W/m
Admiss. ambient temp.	0-40 °C
Dimensions	80 x 100 x 60 mm
Weight	0.37 kg



DH-10

Order No. 0160010



Horn speaker

- Moisture-proof
- 8 Ω speaker system

Model	DH-10
Total power rating	10 W
Power rating (RMS)	5 W
Frequency range	350-10,000 Hz
SPL	97 dB/W/m
Admiss. ambient temp.	0-40 °C
Dimensions	120 x 130 x 115 mm
Weight	0.52 kg



RUP-5

Order No. 0160280



Horn speaker

- Moisture-proof
- 8 Ω speaker system

Model	RUP-5
Total power rating	10 W
Power rating (RMS)	5 W
Frequency range	400-8,000 Hz
SPL	102 dB/W/m
Beam angle	H: 90°/V: 90°
Admiss. ambient temp.	0-40 °C
Dimensions	Ø 130 mm x 130 mm
Weight	0.415 kg



RUS-5

Order No. 0160290



Horn speaker

- Moisture-proof
- 8 Ω speaker system

Model	RUS-5
Total power rating	8 W
Power rating (RMS)	4 W
Frequency range	400-8,000 Hz
SPL	102 dB/W/m
Beam angle	H: 45°/V: 110°
Admiss. ambient temp.	0-40 °C
Dimensions	90 x 105 x 125 mm
Weight	0.417 kg



Replacement Voice Coils

For horn systems.



Model	Order No.	For	Total power rating	Power rating	Impedance
IT-230/VC	0160750	IT-20, IT-30, IT-35, UHC-30, NR-33KS	15 W (IT-20)	15/10/5/2,5 W (IT-20)	8 Ω (UHC-30, NR-33KS)
			20 W (IT-30)	20/15/10/5 W (IT-30)	
			25 W (IT-35)	25/20/15/10/5 W (IT-35)	
			40 W (UHC-30)	20 W (UHC-30)	
			25 W (NR-33KS)	12 W (NR-33KS)	
IT-40/VC	0161380	IT-40, NR-40KS	40 W (IT-40)	40/30/20/10/5 W (IT-40)	16 Ω (NR-40KS)
			60 W (NR-40KS)	30 W (NR-40KS)	
KU-516/VC	0160730	KU-516	75 W	50 W	16 Ω
KU-616T/VC	0160720	KU-616T	40 W	40/30/20/10/5 W	-

Speakers

Horn Speakers

KU-916T

Order No. 0161610



Weatherproof horn driver

- 100 V transmission technology
- Protected against powerful water jets
- Power selector switch
- 3.5 cm (1 3/8") mounting flange
- 60 cm connection cable

Model	KU-916T
Power rating (RMS)	60/50/40/30/20/10 W
Frequency range	160-7,000 Hz
SPL	113 dB/W/m
Admiss. ambient temp.	-20 °C to +50 °C
Dimensions	Ø 150 mm x 158 mm
Weight	2.75 kg



KU-616T

Order No. 0160710



Weatherproof horn driver

- 100 V transmission technology
- Protected against powerful water jets
- Power selector switch
- 3.5 cm (1 3/8") mounting flange
- 55 cm connection cable

Model	KU-616T
Power rating (RMS)	40/30/20/10/5 W
Frequency range	160-6,500 Hz
SPL	112 dB/W/m
Admiss. ambient temp.	-20 °C to +50 °C
Dimensions	Ø 150 mm x 136 mm
Weight	2.2 kg



KU-516

Order No. 0160700



Weatherproof horn driver

- Diecast version, IP66
- Protected against powerful water jets
- 3.5 cm (1 3/8") mounting flange

Model	KU-516
Total power rating	75 W
Power rating (RMS)	50 W
Frequency range	160-6,500 Hz
SPL	113 dB/W/m
Admiss. ambient temp.	-20 °C to +50 °C
Dimensions	Ø 126 mm x 100 mm
Weight	1.9 kg



IT-10M

Order No. 0160470



Flush-mount horn speaker (music horn) with full range speaker

- For wall mounting and ceiling installation
- 100 V transmission technology with 3 power taps
- After installation weatherproof and IP54 certified
- 5 cm (2.5") full range speaker with horn front attachment
- Suitable for general indoor and outdoor applications wherever a high sound pressure level and an excellent sound are required
- ABS plastic housing
- Mounting flange with foam rubber sealing

Model	IT-10M
Power rating (RMS)	10/5/2.5 W
Frequency range	200-15,000 Hz
SPL	98 dB/W/m
Beam angle	H: 100°/V: 100°
Dimensions	120 x 120 x 120 mm mounting cutout: Ø 101 mm
Weight	0.75 kg

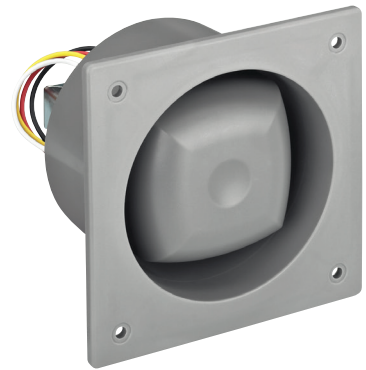
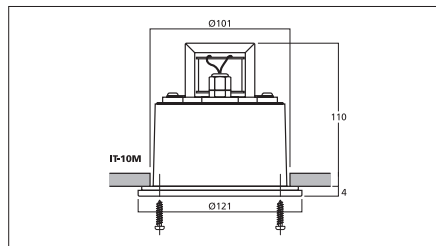

NR-10M

Order No. 0160480



Flush-mount horn speaker (music horn) with full range speaker, 4 Ω

- For wall mounting and ceiling installation
- After installation weatherproof and IP54 certified
- 4 Ω speaker system
- 5 cm (2.5") full range speaker with horn front attachment
- Suitable for general indoor and outdoor applications wherever a high sound pressure level and an excellent sound are required
- ABS plastic housing
- Mounting flange with foam rubber sealing

Model	NR-10M
Total power rating	20 W
Power rating (RMS)	10 W
Frequency range	200-15,000 Hz
SPL	98 dB/W/m
Beam angle	H: 100°/V: 100°
Dimensions	120 x 120 x 120 mm mounting cutout: Ø 101 mm
Weight	0.48 kg

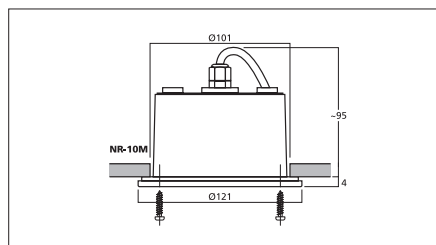

ITH-300

Order No. 0163360



Pole mount set, for PA horn speakers or cameras.

- Suitable for mounting, e.g. IT-130, IT-300TW, IT-40, IT-400TW
- Load capacity: 100 kg (when installed by an expert)
- For pole diameter: up to Ø 300 mm
- Mounting plate and mounting accessories made of V2A steel

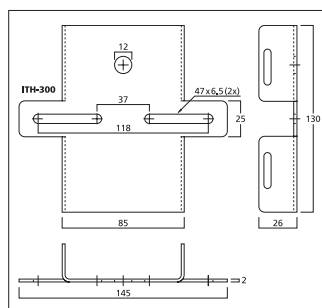

Supplied w/o speakers.

Special tools are required for installation. Further information can be obtained from the sales department at MONACOR.

For installation by experts only, as otherwise persons and units will be put at risk.

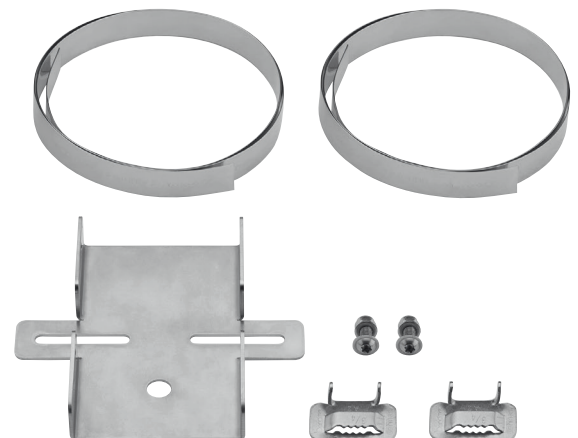
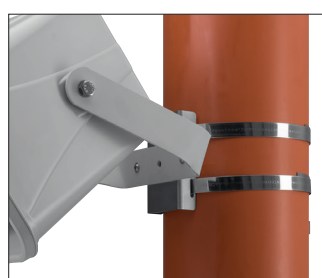

Speakers

Pendant Speakers

IMC-300T/EN

Order No. 0163910



High-quality 2-way PA pendant speaker, with perfect 360° sound radiation and EN 54-24 certification.

- 100 V transmission technology: 30/20/10 W
- 2-way coaxial speaker (6.5")
- Elaborate reflector design for a wide and homogeneous omnidirectional radiation
- Excellent sound reproduction due to the attached housing, even down to the bass range
- Recommended installation height: approx. 4 m (reflector)
- White lacquered sheet steel housing

Model	IMC-300T/EN
Power rating (RMS)	30/20/10 W
Frequency range	60-20,000 Hz
SPL	83 dB/W/m
Beam angle	H: 360°/V: 160°
Dimensions	Ø 480 mm x 300 mm
Weight	4.5 kg

- Device is suspended via steel safety ropes and snap hooks
- Cable inlet via high-strength cable gland (PG11)
- Ceramic terminal



EDL-435/WS

Order No. 0163460



High-quality 2-way PA pendant speaker

- 100 V transmission technology
- 2-way coaxial system
- High-quality sound for speech and music
- White ABS bass-reflex housing with steel grille
- 5 m connection cable with canopy

Model	EDL-435/WS
Power rating (RMS)	30/20/15/10/5 W
Frequency range	80-20,000 Hz (-10 dB) 70-20,000 Hz (-20 dB)
SPL	91 dB/W/m
Dimensions	Ø 185 mm x 230 mm
Weight	2.22 kg



EDL-430/WS

Order No. 0162370



Top-quality PA ball speaker, with a perfect omnidirectional sound radiation.

- 100 V transmission technology
- High-performance full range speaker
- Extensive reflector design
- Great speech intelligibility
- White ABS housing
- 150 cm connection cable with canopy

Model	EDL-430/WS
Power rating (RMS)	20/10/5 W
Frequency range	80-15,000 Hz
SPL	92 dB/W/m
Beam angle	360°
Dimensions	Ø 250 mm
Weight	2.3 kg



EDL-420/SW

Order No. 1000621



EDL-420/WS

Order No. 0161880



Weatherproof PA ball speakers

- 100 V transmission technology or 8 Ω operation
- Black (SW) or white (WS) ABS housing, self-extinguishing, complies with standard UL 94V-0
- Supplied with 480 cm connection cable and canopy

Model	EDL-420/SW, EDL-420/WS
Power rating (RMS)	20/10/5 W
Frequency range	120-20,000 Hz
SPL	94 dB/W/m
Dimensions	Ø 265 mm
Weight	2.3 kg



EDL-416EN/WS

Order No. 0163420



Moisture-proof PA ball speaker, with EN 54-24 certification, 1438-CPR-0535.

- 100 V transmission technology
- White ABS housing (UL 94HB), UV-resistant and weatherproof
- Moisture-proof speaker cone
- Supplied with 450 cm connection cable and canopy
- Ceramic connection terminal, thermal fuse

Model	EDL-416EN/WS
Power rating (RMS)	16/8/4 W
Frequency range	130-18,000 Hz
SPL	89.9 dB/W/m
Beam angle	196° (1 kHz) 132° (2 kHz) 170° (4 kHz)
Admiss. ambient temp.	-20 °C to +80 °C
Dimensions	Ø 185 mm x 157 mm
Weight	1.6 kg



EDL-412/SW

Order No. 1000620



EDL-412/WS

Order No. 0161860



Weatherproof PA ball speakers

- 100 V transmission technology or 8 Ω operation
- Black (SW) or white (WS) ABS housing, self-extinguishing, complies with standard UL 94V-0
- Supplied with 480 cm connection cable with canopy

Model	EDL-412/SW, EDL-412/WS
Power rating (RMS)	10/5/2.5 W
Frequency range	160-20,000 Hz
SPL	92 dB/W/m
Dimensions	Ø 184 mm
Weight	1.65 kg



RL-1ENABDS

Order No. 0163690



PA A/B sound projector for wall mounting, with EN 54-24 certification for voice evacuation systems with A/B speaker distribution according to EN 60849.

- 100 V transmission technology
- 13 cm full range speaker with dual voice coil
- 2 x 100 V transformer with power taps on the cable 6/3/1.5 W
- Connection via 2 x 4-core cable (length: 1.5 m)
- Metal housing with front protective grille
- Supplied with pan/tilt bracket and mounting accessories

Model	RL-1ENABDS
Power rating (RMS)	2 x 6/3/1.5 W
Frequency range	80-20,000 Hz
SPL	93 dB/W/m
Beam angle	130°
Dimensions	Ø 144 mm x 210 mm
Weight	2.3 kg



RL-1EN

Order No. 0163680



PA sound projector for wall mounting, with EN 54-24 certification.

- 100 V transmission technology
- 13 cm full range speaker
- 100 V transformer with power taps on the cable 6/3/1.5 W
- Connection via 4-core cable (length: 1.5 m)
- Metal housing with front protective grille
- Supplied with pan/tilt bracket and mounting accessories

Model	RL-1EN
Power rating (RMS)	6/3/1.5 W
Frequency range	80-20,000 Hz
SPL	93 dB/W/m
Beam angle	130°
Dimensions	Ø 144 mm x 210 mm
Weight	1.9 kg



Speakers

Projector Speakers

EDL-250/SW

Order No. 1000763



EDL-250/WS

Order No. 0162290



Weatherproof PA sound projector

- 100 V transmission technology
- Weatherproof plastic housing
- Connection cable with 3 power taps
- Pivoting mounting bracket



Model	EDL-250/SW	EDL-250/WS
Power rating (RMS)	30/15/7.5 W	30/15/7.5 W
Frequency range	125-15,000 Hz	125-15,000 Hz
SPL	101 dB/W/m	101 dB/W/m
Dimensions	Ø 180 mm x 200 mm	Ø 180 mm x 200 mm
Weight	2.1 kg	2.1 kg

EDL-220/WS

Order No. 0161950



Weatherproof PA sound projector

- 100 V transmission technology
- 2 speakers with polypropylene cone for bilateral radiation
- Splashproof due to plastic housing with rubber seals
- Connection cable with 3 power taps
- Pivoting mounting bracket and screws made of stainless steel

Model	EDL-220/WS
Power rating (RMS)	20/10/5 W
Frequency range	120-20,000 Hz
SPL	94 dB/W/m
Dimensions	Ø 180 mm x 251 mm
Weight	2.76 kg



EDL-110/WS

Order No. 0161930



Weatherproof PA sound projector

- 100 V transmission technology
- 1 speaker with polypropylene cone
- Splashproof due to plastic housing with rubber seals and high-strength cable gland
- Connection cable with 3 power taps
- Stainless steel screws and pivoting mounting bracket

Model	EDL-110/WS
Power rating (RMS)	10/5/2.5 W
Frequency range	120-20,000 Hz
SPL	94 dB/W/m
Dimensions	Ø 180 mm x 270 mm
Weight	2 kg



EDL-255/WS

Order No. 0160860



PA sound projector

- 100 V transmission technology or 8 Ω operation
- 6-step power selector switch for 15/8/4/2 W/off or 8 Ω operation
- White plastic housing with pivoting mounting bracket

Model	EDL-255/WS
Power rating (RMS)	15/8/4/2 W
Frequency range	100-15,000 Hz
SPL	92 dB/W/m
Dimensions	Ø 180 mm x 280 mm
Weight	2.59 kg



DA-P20-130/T

Order No. 0163880



Weatherproof PA sound projector, for wall mounting and with EN 54-24 certification.

- 100 V transmission technology
- 13 cm waterproof full range speaker
- 100 V transformer with power taps 20/10/5/2.5 W
- Connection via ceramic terminal and thermal fuse in the junction box (cable length: 1 m)

Model	DA-P20-130/T
Power rating (RMS)	20/10/5/2.5 W
Frequency range	150-20,000 Hz
SPL	90 dB/W/m
Admiss. ambient temp.	-20 °C to +90 °C
Dimensions	Ø 145 mm x 222 mm
Weight	1.367 kg

- ABS plastic housing with front protective grille
- Robust aluminium mounting bracket



DA-10-260/T

Order No. 0163710



Weatherproof PA sound projector, for wall mounting and with EN 54-24 certification.

- 100 V transmission technology
- 2 x 13 cm full range speaker for bi-directional radiation
- 100 V transformer with power taps 10/6/3/1.5 W
- Connection via ceramic terminals with thermal fuse in the mounting base

Model	DA-10-260/T
Power rating (RMS)	10/6/3/1.5 W
Frequency range	120-17,000 Hz
SPL	93 dB/W/m
Beam angle	150°
Admiss. ambient temp.	-20 °C to +90 °C
Dimensions	166 x 197 x 161 mm
Weight	2.31 kg

- Robust plastic-coated aluminium housing with front protective grille
- Robust vandal-resistant aluminium mounting base



AES-7

Order No. 0131100



Extension speaker, 5 W, 6 Ω

- 4 Ω or 8 Ω operation
- Black plastic housing
- Mounting bracket
- 1.70 m connection cable with 3.5 mm plug
- Frequency range: 300-15,000 Hz
- Dimensions: 130 x 65 x 58 mm
- Weight: 330 g



AES-6

Order No. 0132300



Extension speaker, 3 W, 8 Ω

- Black plastic housing
- Moisture-proof due to speaker with solid plastic cone
- Mounting bracket
- 1.70 m connection cable with 3.5 mm plug
- Frequency range: 300-15,000 Hz
- Dimensions: 80 x 75 x 45 mm
- Weight: 200 g



AES-5

Order No. 0130020



Special speaker, 3 W, 4 Ω

- Compact, moisture-proof version
- Extra robust
- Optimised voice reproduction
- Supplied with 2 m connection cable and 3.5 mm mono plug
- Frequency range: 300-8,000 Hz



WSA-2

Order No. 0255790



Bluetooth audio receiver,

- Multipoint Bluetooth (simultaneous pairing of 2 units)
- Scope of delivery: wireless audio streamer, plug-in power supply, audio cable RCA to 3.5 mm stereo plug

Model	WSA-2
Bluetooth	version 3.0, class 2
Operating range	10 m (typ.) 20 m (clear view)
Profiles	A2DP
Power supply	via encl. power supply
Dimensions	50 x 24 x 56 mm
Weight	33 g
Connections	Outputs: 1 x RCA L/R 1 x 3.5 mm jack, stereo



WSA-10BT

Order No. 0255800



Bluetooth audio receiver, for playing tracks from mobile audio devices directly on your audio system.

- Audio streaming directly from any Bluetooth device
- Supports aptX for an improved audio quality
- Autopairing
- Up to 10 paired devices can be stored
- Optical and coaxial digital output, analogue line level output

Model	WSA-10BT
Frequency range	20-20,000 Hz
THD	0.05%
Channel separation	45 dB
Bluetooth	4.0, class 2
Operating range	10 m (typ.) 20 m (clear view)
Profiles	A2DP
Power supply	via encl. power supply
Dimensions	91 x 25 x 57 mm
Weight	60 g
Connections	Outputs: 1 x Toslink, optical/digital 1 x RCA, digital 1 x 3.5 mm stereo jack, analogue



WSA-20BT

Order No. 0257130



Bluetooth audio receiver, for playing music tracks from mobile audio devices directly on your audio system.

- Audio streaming directly from any Bluetooth device
- Analogue line level output via 6.3 mm jacks L/R
- LED for status indication
- Integrated magnets for attaching it e.g. to a device housing

Model	WSA-20BT
Frequency range	20-20,000 Hz
THD	≤ 0.01%
Channel separation	≥ 75 dB
Bluetooth	Bluetooth V4.0, class 2
Operating range	≤ 10 m
Profiles	HFP, HSP, A2DP, AVRCP, DI
Power supply	via encl. power supply
Dimensions	116 x 35 x 86 mm
Weight	117 g
Connections	Outputs: 1 x 6.3 mm stereo jack L/R, analogue



WSA-50WIFI

Order No. 0257160

**SMART
HOME
READY****WLAN audio receiver,**

for audio streaming from your smartphone, tablet PC, stationary PC or Mac. The device receives audio signals via network and then transmits them to a stereo system or an active speaker via cable.

- Audio streaming directly from any device
- Operating modes: Access Point (AP) or Station (STA)
- WLAN standard: IEEE802.11a/b/g/n
- DLNA, AirPlay
- File formats: e.g. MP3, FLAC, WAV, APE, WMA, AAC
- Data transmission rate: up to 7 Mbps
- Integrated browser
- Free app available, e.g. iMediaShare
- LED status indication
- Volume level control
- Analogue line level output via 6.3 mm jacks L/R and 3-pole XLR L/R

Model	WSA-50WIFI
Frequency range	20-20,000 Hz
THD	≤ 0.1%
Channel separation	≥ 90 dB
Operating range	> 20 m (AP) > 50 m (STA)
Power supply	via encl. power supply
Dimensions	130 x 54 x 130 mm
Weight	516 g
Connections	Outputs: 1 x 6.3 mm stereo jack L/R, analogue 1 x 3-pole XLR L/R, analogue
Other features	DLNA, AirPlay, HTTP

- Metal housing
- Power is provided via enclosed plug-in power supply

**WSA-24T**

Order No. 0257150

Wireless stereo transmitter, 2.4 GHz, for audio streaming.

- Matching the receiver WSA-24R
- Stereo/mono selector switch
- LED for indicating status and peak
- Interference-free operation due to FHSS technology (Frequency Hopping Spread Spectrum)
- Analogue line level input via 6.3 mm jacks L/R and 3-pole XLR L/R
- Metal housing
- Power is provided via enclosed plug-in power supply

Model	WSA-24T
Frequency range	20-20,000 Hz
THD	< 0.3%
Channel separation	≥ 90 dB
Operating range	> 30 m, without any obstacles
Power supply	via encl. power supply
Dimensions	130 x 54 x 130 mm
Weight	470 g
Connections	Inputs: 1 x 6.3 mm stereo jack L/R, analogue 1 x 3-pole XLR L/R, analogue
Other features	2.4 GHz, 25 channels, latency: 18 ms

**WSA-24R**

Order No. 0257140

Wireless stereo receiver, 2.4 GHz, for audio streaming.

- Matching the transmitter WSA-24T
- Interference-free operation due to FHSS technology (Frequency Hopping Spread Spectrum)
- Analogue line level output via 6.3 mm jacks L/R
- Plastic housing
- Power is provided via enclosed plug-in power supply

Model	WSA-24R
Frequency range	20-20,000 Hz
THD	< 0.3%
Channel separation	≥ 90 dB
Power supply	via encl. power supply
Dimensions	116 x 35 x 86 mm
Weight	118 g
Connections	Outputs: 1 x 6.3 mm stereo jack L/R, analogue
Other features	2.4 GHz, 25 channels, latency: 18 ms



Audio Streaming Dante®

WALL-05DTM/WS

Order No. 1000788



Active speaker with integrated Dante® module

- 2-way system
- 13 cm (5") bass-midrange speaker and 13 mm (1/2") tweeter
- Mounting bracket for pivoting and tilting
- Power supply via PoE (Power over Ethernet) or via optional power supply (19 V/2.5 A)

Model	WALL-05DTM/WS
Power rating (RMS)	30 W
Frequency range	62-20,000 Hz
SPL	89 dB/W/m
Power supply	PoE or power supply 19 V/2.5 A (not supplied)
Dimensions	163 x 252 x 165 mm
Weight	2.12 kg
Inputs	1 x RJ45 (Dante® In)
Outputs	1 x RJ45 (feed-through output)



System requirements Dante®: Windows 7/8.1/10/11 or MacOS 10.9.5/10.10.5/10.11

The brand Dante® as well as the Dante® software which may have been integrated into these products are licenced by Audinate Pty Ltd.

IT-400DT

Order No. 0163870



Weatherproof active horn speaker (music horn), 2-way technology

- With integrated Dante® module and DSP
- DSP-controlled 20 W amplifier
- Power supply via PoE (Power over Ethernet)
- Weatherproof and IP66 certified
- Very wideband sound with a distinct bass volume, even at very high volume levels
- 16 cm bass-midrange speaker and 25 mm (1") horn
- Robust plastic housing
- Supplied with mounting bracket and screws made of stainless steel

Model	IT-400DT
Power rating (RMS)	20 W
Frequency range	100-20,000 Hz
SPL	98 dB/W/m
Beam angle	H: 100°/V: 60°
Admiss. ambient temp.	-20 °C to +50 °C
Power supply	PoE
Dimensions	420 x 335 x 400 mm
Weight	6.12 kg
Inputs	1 x RJ45



System requirements Dante®: Windows 7/8.1/10 or MacOS 10.9.5/10.10.5/10.11

ETS-630DT

Order No. 0163490



Active PA column speaker, with integrated Dante® module.

- 30 W class D amplifier
- 6 x 7.6 cm (3") full range speaker
- Decoding: 16/24/32 bits
- Sampling rates: 44.1/48/88.2/96 kHz
- PoE (Power over Ethernet)
- 2 x M12 threaded bushing
- Metal cabinet with white metal front grille
- Supplied with mounting bracket

Model	ETS-630DT
Power rating (RMS)	30 W
Frequency range	120-18,000 Hz
SPL	95 dB/W/m
Beam angle	H: 120°/V: 40°
Power supply	PoE
Dimensions	95 x 610 x 120 mm
Weight	5.57 kg
Inputs	RJ45



System requirements Dante®: Windows 7/8.1/10 or MacOS 10.9.5/10.10.5/10.11

The brand Dante® as well as the Dante® software which may have been integrated into these products are licenced by Audinate Pty Ltd.

EDL-80DT

Order No. 0163480



Active 2-way flush-mount ceiling speaker, with integrated Dante® module.

- 30 W amplifier
- 20 cm (8") bass speaker with glass fibre cone, 2.5 cm (1") dome tweeter
- Decoding: 16/24/32 bits
- Sampling rates: 44.1/48/88.2/96 kHz
- Power supply via PoE (Power over Ethernet)
- Plastic frame and protective metal grille
- For a ceiling thickness up to 4 cm
- Mounting cutout: Ø 240 mm
- Mounting depth: 225 mm incl. space requirement for network connection

Model	EDL-80DT
Power rating (RMS)	30 W
Frequency range	100-20,000 Hz
SPL	93 dB/W/m
Beam angle	100°
Power supply	PoE via RJ45
Dimensions	Ø 272 mm x 187 mm
Weight	2.7 kg
Inputs	RJ45



System requirements Dante®: Windows 7/8.1/10 or MacOS 10.9.5/10.10.5/10.11

The brand Dante® as well as the Dante® software which may have been integrated into these products are licenced by Audinate Pty Ltd.

DADC-144DT

Order No. 0257910



4-channel Dante® transceiver

- 4 analogue XLR audio inputs
- 4 analogue XLR audio outputs
- 4-channel Dante® input/output (EtherCon/RJ45)
- Analogue input and output levels can be adjusted individually via recessed potentiometers
- 48 V phantom power can be activated as required for each analogue input
- Mute function for each analogue output
- Dante® sources and Dante® receiver can be combined via software
- Encoding/decoding: 16/24/32 bits

- Sampling rates: 44.1/48/88.2/96 kHz
- Frequency range: 20-20,000 Hz
- LED display for indicating signal, peak, network link, network act and power
- Metal housing
- 482 mm (19") rack installation, 1 RU

The brand Dante® as well as the Dante® software which may have been integrated into these products are licenced by Audinate Pty Ltd.



Model	DADC-144DT
Frequency range	20-20,000 Hz
Input signal	2.3 V max.
Input sensitivity	5.7 mV-2.3 V
Gain	0.2-5.2x
Phantom power	48 V
S/N ratio	> 90 dB
THD	< 0.005%
Power supply	230 V/50 Hz/15 VA
Dimensions	482 x 44.5 x 238 mm, 1 RU
Weight	2.9 kg

AKB-160DT

Order No. 0176070



PA amplifier module with integrated Dante® module

- 1 x 40 W
- 100 V output
- Silent operation due to fanless cooling concept
- Dante® input
- Speaker output via screw terminal
- Metal housing with mounting brackets

Model	AKB-160DT
Peak output power	60 W
Power rating at 100 V	40 W
Inputs	network
Frequency range	17-20,000 Hz
S/N ratio	> 80 dB
THD	< 1%
Power supply	~ 230 V/50 Hz/75 VA
Dimensions	213 x 55 x 238 mm
Weight	3.2 kg
Connections	1 x RJ45 (Dante®)

The brand Dante® as well as the Dante® software which may have been integrated into these products are licenced by Audinate Pty Ltd.



System requirements Dante®: Windows 7/8.1/10 or MacOS 10.9.5/10.10.5/10.11

ECM-300DT

Order No. 0236910



PA desktop microphone (push-to-talk) with integrated Dante® module

- Electret, hypercardioid polar pattern
- Selectable operating modes: push-to-mute (PTM), push-to-talk (PTT), on/off, off/on
- Low cut switch, switchable attenuation: -10/-20/-30 dB
- Encoding: 16/24/32 bits
- Sampling rates: 44.1/48/88.2/96 kHz
- RJ45 jack for connection to a Dante® network
- Power supply via PoE (Power over Ethernet)

Model	ECM-300DT
Polar pattern	hypercardioid
System	electret
Audio frequency range	50-16,000 Hz
Nominal impedance	250 Ω
Sensitivity	10 mV/Pa
S/N ratio	139 dB
Power supply	PoE
Gooseneck length	310 mm
Dimensions	90 x 40 x 130 mm (console housing)
Weight	876 g
Connection	RJ45

The brand Dante® as well as the Dante® software which may have been integrated into these products are licenced by Audinate Pty Ltd.



System requirements Dante®: Windows 7/8.1/10 or MacOS 10.9.5/10.10.5/10.11

TPE-TG80G

Order No. 0069200



Gigabit Power over Ethernet switch

- 8 ports (RJ45) with 10/100/1,000 Mbps each, 8 PoE/PoE+ ports
- Bandwidth: 16 Gbps
- Power per port: 30 W (PoE+), 15.4 W (PoE)
- Total power of PoE: 105 W
- Compatible with standards IEEE802.3 10BaseT, IEEE802.3u 100BaseTX, IEEE802.3ab 1000BaseT, IEEE802.3at, IEEE802.3af, IEEE802.3x, IEEE802.3az
- Metal housing
- Power is provided via enclosed power supply



- Admissible ambient temperature: 0-40 °C
- Dimensions: 142 x 30 x 95 mm
- Weight: 400 g

TPE-TG44G

Order No. 0069190



Gigabit Power over Ethernet switch

- 8 ports (RJ45) with 10/100/1,000 Mbps each, 4 of which PoE/PoE+ ports
- Bandwidth: 16 Gbps
- Power per port: 30 W (PoE+, 2 ports max.), 15.4 W (PoE, 4 ports max.)
- Total power of PoE: 60 W
- Compatible with standards IEEE802.3 10BaseT, IEEE802.3u 100BaseTX, IEEE802.3ab 1000BaseT, IEEE802.3at, IEEE802.3af, IEEE802.3x, IEEE802.3az
- Metal housing



- Power is provided via enclosed power supply
- Admissible ambient temperature: 0-40 °C
- Dimensions: 142 x 30 x 95 mm
- Weight: 380 g

PA-900DT

Order No. 0176080



Mono PA mixing amplifier with integrated Dante® module

- 1 x 120 W
- Silent operation due to fanless cooling concept
- 3 balanced mic/line inputs
- Dante® input
- Mic 1 with priority circuit and automatic talkover
- Additional connection for desktop microphone via screw terminal
- 1 aux input
- Speaker outputs via screw terminals
- Line output
- Insert facility, e.g. for effect units, equalizers, feedback controllers
- Input and output level controls
- 2-way tone control for the output
- 20 V phantom power for each microphone input, can be activated individually
- Mains operation or 24 V emergency power operation
- Removable mounting brackets



System requirements Dante®: Windows 7/8.1/10 or MacOS 10.9.5/10.10.5/10.11

The brand Dante® as well as the Dante® software which may have been integrated into these products are licenced by Audinate Pty Ltd.

Model	PA-900DT
Peak output power	160 W
Power rating at 4 Ω	120 W
Power rating at 100 V	120 W
Inputs	3 mV (mic), 200 mV (line), 140 mV (aux)
Frequency range	50-15,000 Hz
Equalizer bass	± 10 dB/100 Hz
Equalizer treble	± 10 dB/10 kHz
S/N ratio	> 80 dB
THD	< 0.5%
Power supply	~ 230 V/50 Hz/300 VA, = 24 V/9 A
Dimensions	482 x 88 x 275 mm, 2 RU
Weight	9.9 kg
Connections	3 x XLR (mic/line), 1 x RCA L/R (aux), 1 x RJ45 (Dante®), screw terminals (speakers)

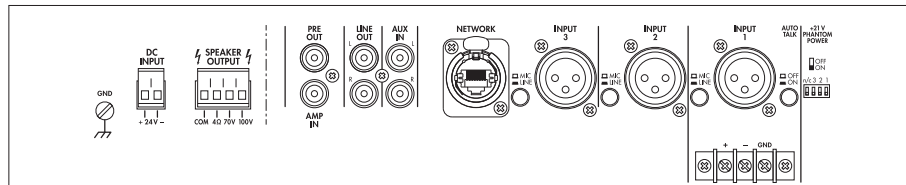

DRM-884

Order No. 0176940



Audio matrix router

- 8 analogue inputs and 8 analogue outputs
- 4 digital inputs and 4 digital outputs for the extensions DRM-884RC, DRM-884IOP and DRM-VAP
- An additional 8 digital inputs and 8 digital outputs via Dante® module DRM-884DTM, available at option
- DSP for inputs and outputs, control via software
- Integrated auto mixer, feedback controller and ducker
- Predefined types of filters 6-48 dB/oct. (Butterworth, Bessel, Linkwitz-Riley)
- Up to 2 zone paging microphones DRM-884RC can be connected



- Wall modules DRM-884IOP, DRM-884VAP and DRM-884VP can be connected as remote control
- Link function for several audio matrix routers DRM-884
- Can be remote-controlled via RS-232 interface or app (Android)
- LCD for showing device information
- LED status indication

- LED indication for clip and signal per input and output
- 482 mm (19") rack installation

System requirements: Windows 7/8/10

Model	DRM-884
Frequency range	20-20,000 Hz
Input impedance	5 kΩ
Output impedance	240 Ω
Phantom power	48 V
Channel separation	> 87 dBa
THD	< 0.01%
Power supply	~ 230 V/50 Hz/80 VA
Dimensions	482 x 44 x 270 mm, 1 RU
Weight	4.22 kg
Inputs	screw terminals
Outputs	screw terminals
Other features	5 x RJ45

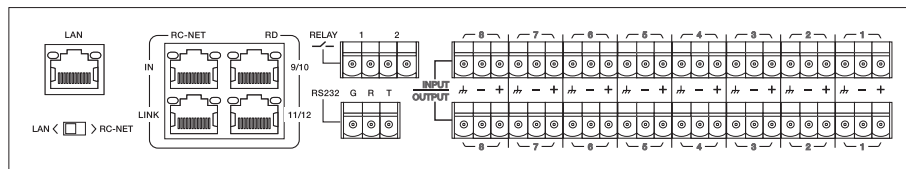

DRM-884DTM

Order No. 0176950



- **Dante® module**, for inserting audio matrix router DRM-884 into a Dante® network.
- Audio transmission via Ethernet using Dante® protocol
- 8 digital inputs and 8 digital outputs
- Easy signal control via network technology

- Mini PCI plug-in board
- Connections: 2 x RJ45

System requirements: Windows 7/8/10 or MacOS X

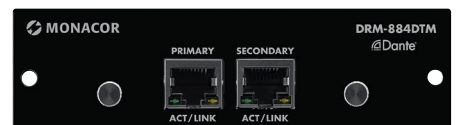

The brand Dante® as well as the Dante® software which may have been integrated into these products are licenced by Audinate Pty Ltd.

ADP-DAI-1X0

Order No. 0259650



Dante® AVIO analogue input adapter (1-channel)

- For connecting analogue audio line level devices (e.g. mixer) to a Dante® audio network
- Adjustable signal level: +24/+4/0 dBu, 0/-10 dBV (via Dante® controller)
- Frequency range: 20-20,000 Hz
- Impedance: 20 kΩ (bal.), 10 kΩ (unbal.)
- Dynamic range: > 100 dB

- S/N ratio: > 100 dB
- THD: < 0.01%
- Sampling rates: 44.1/48/96 kHz, 24 bits
- Connections: 1 x RJ45, 1 x XLR inline jack

ADP-DAI-2X0

Order No. 0259660



Dante® AVIO analogue input adapter (2-channel)

- For connecting analogue audio line level devices (e.g. mixer) to a Dante® audio network
- Adjustable signal level: +24/+4/0 dBu, 0/-10 dBV (via Dante® controller)
- Frequency range: 20-20,000 Hz
- Impedance: 20 kΩ (bal.), 10 kΩ (unbal.)
- Dynamic range: > 100 dB

- S/N ratio: > 100 dB
- THD: < 0.01%
- Sampling rates: 44.1/48/96 kHz, 24 bits
- Connections: 1 x RJ45, 2 x XLR inline jack

ADP-DAO-0X1

Order No. 0259670



Dante® analogue output adapter (1-channel)

- For connecting analogue audio line level devices (e.g. active speakers) to a Dante® audio network
- Adjustable signal level: +18/+4/0 dBu, 0/-10 dBV (via Dante® controller)
- Frequency range: 20-20,000 Hz
- Impedance: 150 kΩ (bal.), 75 kΩ (unbal.)
- Dynamic range: > 100 dB

- S/N ratio: > 100 dB
- THD: < 0.01%
- Sampling rates: 44.1/48/96 kHz, 24 bits
- Connections: 1 x RJ45, 1 x XLR plug

ADP-DAO-0X2

Order No. 0259680



Dante® analogue output adapter (2-channel)

- For connecting analogue audio line level devices (e.g. active speakers) to a Dante® audio network
- Adjustable signal level: +18/+4/0 dBu, 0/-10 dBV (via Dante® controller)
- Frequency range: 20-20,000 Hz
- Impedance: 150 kΩ (bal.), 75 kΩ (unbal.)
- Dynamic range: > 100 dB

- S/N ratio: > 100 dB
- THD: < 0.01%
- Sampling rates: 44.1/48/96 kHz, 24 bits
- Connections: 1 x RJ45, 2 x XLR plug

ADP-USB-2X2

Order No. 0259690



Dante® AVIO USB adapter

- For connecting a computer to a Dante® audio network
- 2-channel recording/reproduction
- Sampling rate: 48 kHz, 24 bits
- Compatible with Windows, Mac OS, iOS and Android devices, no drivers required
- Connections: 1 x RJ45, 1 x USB Type-A

ADP-AES3-2X2

Order No. 0259640



Dante® AVIO AES3/EBU adapter

- For connecting analogue devices with AES3/EBU interface to a Dante® audio network
- Impedance: 110 Ω (bal.)
- S/N ratio: > 135 dB
- Sampling rates: 44.1/48/96 kHz, 24 bits
- Connections: 1 x RJ45, 1 x XLR plug, 1 x XLR inline jack

ADP-BT-AU-2X1

Order No. 1000801



Dante® AVIO Bluetooth adapter

- For connection a Bluetooth device to a Dante® audio network
- 2-channel recording/playback
- Sampling rate: 48 kHz, 24 bits
- Bluetooth Version 5.0 A2DP (AptX, AAC) und HFP
- Compatible with Windows, Mac OS, iOS and Android devices, no driver required
- Connections: 1 x RJ45

ADP-USBC-2X2

Order No. 1000156



Dante® AVIO USB adapter

- For connecting a computer or a mobile device to a Dante® audio network
- 2-channel recording/playback
- Sampling rate: 48 kHz, 24 bits
- Compatible with Windows, Mac OS, iOS and Android devices, no driver required
- Connections: 1 x RJ45, 1 x USB Type-C™

Audio Streaming 2N®

IP-FORMER

Order No. 1000249



IP audio decoder

The IP-FORMER converts passive speakers into network speakers and thus enables audio streaming via the Internet to existing passive speakers.

Due to its compact design, the IP-FORMER can be mounted directly to the existing passive speaker by using the transformer bracket. The built-in 8 W class D digital audio amplifier delivers high-quality audio signals to the connected wall speaker, ceiling speaker or desktop speaker (2-8 Ω).

The IP-FORMER is powered by an external Power over Ethernet power supply (PoE, IEEE 802.3af).

As a decoder, the IP-FORMER enables audio streaming from radio stations, telephones and intercoms, making it suitable for speakers to play background music and for live announcements, e.g. in schools, office buildings, in the retail trade or for announcements based on the SIP protocol (Session Initiation Protocol).

- Programming and management via web browser
- Supports audio formats, e.g. MP3, MPEG-4, linear PCM, G.711, G722, GSM, Opus, etc.
- LAN connection, Ethernet RJ45, 10/100 Mbps
- Screw terminals for speakers and microphone
- Impedance of the connected speaker: 2-8 Ω
- Power supply via PoE (IEEE 802.3af)
- LED status indicator



Model	IP-FORMER
Description	IP audio decoder
Power supply	PoE, IEEE802.3af via external power supply (e.g. POE-130MID)
Dimensions	52 x 66 x 40 mm
Weight	172 g
Connections	RJ45 (LAN), screw terminals (speakers, microphone)

SIP Speakers from 2N®

For playing live messages or scheduled messages. It not only allows you to replay your messages from an IP telephone, you can also play them from your mobile phone or smartphone if a suitable IP control panel is used. Features of a complex audio system with SIP protocol. No further investments required for hardware or software, e.g. a PC.

SIP-SPEAK/SW

Order No. 0175010



SIP-SPEAK/WS

Order No. 0175020



Active SIP speakers

- White (WS) or black (SW) plastic housing
- Integrated amplifier
- Impedance: 8 Ω with an output power of 8 W (with PoE) or 12 W (with power supply via 12 V power supply)
- Supports IP PBX (SIP)
- Server-free audio solution, operation also possible without separate server
- Easy installation via network cable to an existing PoE switch
- Configuration via Web interface or a program
- LAN/WAN connection, Ethernet RJ45; 10/100 Mbps
- Live messages or scheduled messages
- Reserve proxy server in case of control panel failure
- Pivoting mounting bracket for wall mounting
- Power supply via PoE (IEEE 802.3af) or external power supply (= 12 V/2 A)
- Matching power supply is available at option
- 2N® Network Scanner app and 2N® IP Audio Manager are available



Model	SIP-SPEAK/SW	SIP-SPEAK/WS
Transmission technology	LAN, SIP	LAN, SIP
Power rating (RMS)	8 W (PoE) 12 W (12 V)	8 W (PoE) 12 W (12 V)
Impedance	8 Ω	8 Ω
Frequency range	75-20,000 Hz	75-20,000 Hz
THD	0.05%	0.05%
Power supply	PoE or = 12 V/2 A	PoE or = 12 V/2 A
Dimensions	176 x 250 x 143 mm	176 x 250 x 143 mm
Weight	2.3 kg	2.3 kg
Inputs	RJ45, DC in	RJ45, DC in
Outputs	SPK out	SPK out

SIP Horn Speakers from 2N®

Suitable for outdoor applications, with high volume level and perfect speech intelligibility. You can also use it as a useful device for broadcasting live messages in wide open spaces as well as for actively protecting your property. In case an intruder intends to break in, you can react immediately, either with a live message or a preset message to quickly drive away intruders.



SIP-HORN

Order No. 0176420



Active SIP horn speaker

- Integrated amplifier
- Impedance: 8 Ω with an output power of 8 W (with PoE) or 25 W (with power provided via 24 V power supply)
- Supports IP PBX (SIP)
- Serverless audio solution
- Easy installation to an existing PoE switch via network cable
- LAN connection, Ethernet RJ45, 10/100 Mbps
- Connection to VMS thanks to ONVIF compatibility
- Live messages or preset messages via scheduler
- Audio self-test with fault indication
- Noise detection with adjustable threshold for triggering an action
- Pivoting mounting bracket, stainless steel
- Power is provided via PoE (IEEE 802.3af) or external power supply (= 24 V/2 A)
- Matching power supply is available at option
- 2N® Network Scanner app for searching of 2N® IP intercom systems and 2N® access units available within the network

Model	SIP-HORN
Power rating (RMS)	8 W (PoE) 25 W (24 V)
Impedance	8 Ω
Frequency range	400-7,500 Hz (-10 dB) 275-12,000 Hz (-20 dB)
SPL	110 dB/W/m
Colour	grey (RAL 7035)
Protection class	IP67
Admiss. ambient temp.	-30 °C to +60 °C
Power supply	PoE or = 24 V/2 A
Dimensions	Ø 232.7 mm x 309.6 mm
Weight	1.75 kg
Inputs	RJ45

SIP Microphone Station from 2N®

With SIP technology and various functions, e.g. transmission into 12 zones, two-way communication thanks to built-in speaker or reproduction of pre-recorded announcements. Each of the stated functions is available without a server and there is no limitation as to the distance.



SIP-MIC

Order No. 0176410



SIP microphone station

- For transmitting live audio announcements or previously stored messages into different zones
- Connection to existing LAN/WAN network
- Connection facility for external microphone, CD/MP3 player or headphones
- 14 buttons, 12 of them to be programmed as required
- Supports IP PBX (SIP)
- Ethernet via RJ45, 10/100 Mbps
- 2 speakers (2 x 1 W)
- 2 logical inputs for contact or voltage of 5-48 V
- Relay output NO/NC, 48 V/1 A max.
- Audio output, 3.5 mm jack
- Main microphone input, balanced, XLR, integrated 24 V phantom power
- Microphone input, 3.5 mm jack
- Line input, 3.5 mm jack
- Power supply via PoE (IEEE 802.3af) or external power supply (12-32 V/1 A)
- Matching power supply PSS-1230DC is available at option

Model	SIP-MIC
Power supply	PoE or = 12-32 V/1 A via external power supply
Dimensions	209 x 65 x 143 mm
Weight	1.25 kg
Connections	RJ45 (LAN), XLR, bal. (microphone), 3.5 mm jack (microphone), 3.5 mm jack (line in)

CS-W4C/5

Order No. 100017

CS-W4C/6

Order No. 1000124

4-channel diversity UHF PLL wideband receivers for conference system

- Bandwidth: 36 MHz
- 6 groups, each with up to 22 compatible preset channels
- 1,441 selectable individual frequencies
- Conference modes: override, priority and open mode
- RF output and mains voltage output for easily cascading up to 10 x CS-W4C/5 receiver without additional splitter
- REMOSET technology for receiver/transmitter synchronisation
- Removable antennas (BNC connection)
- Auto-scan function
- Pilot tone squelch and noise mute

- Backlit display for indicating the status, e.g. for group/channel, frequency, battery, antenna A/B
- LED for indicating RF level and AF level
- Link connections
- Trigger output
- 482 mm (19") rack installation, 1 RU

There are restrictions or requirements within the EU. Please read the notes regarding wireless systems in the section "IMPORTANT INFORMATION"!



Model	CS-W4C/5	CS-W4C/6
Description	receiver unit	receiver unit
Carrier frequency range	506-542 MHz	626-662 MHz
Audio frequency range	60-16,000 Hz	60-16,000 Hz
THD	< 0.6%	< 0.6%
Dynamic range	> 105 dBA	> 105 dBA
Audio signal receiver	630 mV/600 Ω XLR (line), 63 mV/600 Ω XLR (mic), 316 mV/600 Ω jack	630 mV/600 Ω XLR (line), 63 mV/600 Ω XLR (mic), 316 mV/600 Ω jack
Power supply receiver	~ 110-240 V/50-60 Hz/20 VA	~ 110-240 V/50-60 Hz/20 VA
Dimensions receiver	485 x 45 x 260 mm	485 x 45 x 260 mm
Weight receiver	2.4 kg	2.4 kg

CS-W4T/5

Order No. 1000018

CS-W4T/6

Order No. 1000122

UHF PLL microphone desk stand transmitter for the chairperson

- Back-electret microphone cartridge, supercardioid polar pattern
- 400 mm gooseneck, removable
- REMOSET technology for receiver/transmitter synchronisation
- Adjustable sensitivity
- Switchable transmitting power
- Low cut function
- Automatic switch-off
- Lock function

- LCD for indicating group/channel, audio level and battery status

There are restrictions or requirements within the EU. Please read the notes regarding wireless systems in the section "IMPORTANT INFORMATION"!



Model	CS-W4T/5	CS-W4T/6
Polar pattern	supercardioid	supercardioid
System	back electret	back electret
Carrier frequency range	506-542 MHz	626-662 MHz
Transmitting power	10/50 mW	10/50 mW
Operating time	≈ 25 h	≈ 25 h
Audio frequency range	60-16,000 Hz	60-16,000 Hz
Power supply	2 x batt. AA size, alkaline (not supplied)	2 x batt. AA size, alkaline (not supplied)
Dimensions	138 x 29 x 116 mm (console housing)	138 x 29 x 116 mm (console housing)
Weight	710 g	720 g

W4-CH12

Order No. 1000020

Transport case with integrated charging function, for UHF PLL microphone desk stand transmitter CS-W4T/5.

- For simultaneously charging rech. batteries of up to 12 devices
- Average charging time, depending on condition of rechargeable batteries used: approx. 5 hours

- Each slot with LED for indicating battery charging status
- Mechanical reverse polarity protection
- Protection against overload, short-circuit and deep discharge
- Supplied with 24 x NiMH rech. battery AA size (2,000 mAh)
- Butterfly locks and recessed drop handles
- Stackable

- Matching transport case cover W4-CH12/COVER is available at option and can be ordered separately
- Supplied w/o cover and devices.**



W4-CH1

Order No. 1000019

Charging station, for a UHF PLL microphone desk stand transmitter CS-W4T/5.

- Average charging time, depending on condition of rechargeable batteries used: approx. 3 hours
- LED for indicating batt. charging status
- Mechanical reverse polarity protection

- Protection against overload, short-circuit and deep discharge
 - Supplied with 2 x NiMH rech. battery (2,000 mAh)
- Supplied w/o devices.**



W4-CH12/COVER

Order No. 1000021

Transport case cover

- Suitable for transport case with integrated charging function W4-CH12.



Conference System CS-1

Your opinion will be heard! The control unit CS-1CU, the microphone station for the chairperson CS-1CH and the microphone station for conference delegates CS-1DU together form a conference system with extensive configuration facilities for maximum flexibility.

CS-1CU

Order No. 0173060

Control unit, the control centre of the conference system

- For setting up a system with up to 50 microphone stations (2 x 25)
- Power supply for microphone stations
- Built-in speaker
- Headphone connection
- Keypad lock
- Display of date/time
- Stopwatch
- Test function for connected microphone stations
- Connection facilities for optional devices, e.g. external microphone, telephone coupler, signal processing devices (e.g. equalizer), recorders, amplifiers, audio line sources

Model	CS-1CU
Dimensions	360 x 90 x 150 mm
Weight	1.7 kg
Connections	2 x RCA (input/output for telephone coupler) 2 x RCA (input/output, e.g. for equalizer) 2 x RCA L/R (input/output for recorder) 2 x RCA (input/output for line signals) 1 x XLR (microphone input) 2 x 7-pole DIN jack (connection for microphone stations)



CS-1CH

Order No. 0173070

Microphone station for chairperson

- Back electret cartridge with cardioid polar pattern, optimised for voice transmissions
- Low-distortion speaker
- Reproduction via optional headphones
- Large function button
- Status displays at microphone and desktop station
- Priority button allows to interrupt an ongoing discussion between conference delegates, alternatively with a chime

Model	CS-1CH
Polar pattern	cardioid
System	back electret
Audio frequency range	50-18,000 Hz
Power supply	via control unit CS-1CU
Gooseneck length	400 mm
Dimensions	115 x 65 x 170 mm (console housing)
Weight	1.1 kg
Connection	2 x 3.5 mm jack 1 x 2 m connection cable with 7-pole DIN plug 1 x 7-pole DIN jack



CS-1DU

Order No. 0173080

Microphone station for conference delegates

- Back electret cartridge with cardioid polar pattern, optimised for voice transmissions
- Low-distortion speaker
- Operation via function button
- Headphone connection
- Status displays at microphone and desktop station

Model	CS-1DU
Polar pattern	cardioid
System	back electret
Audio frequency range	50-18,000 Hz
Power supply	via control unit CS-1CU
Gooseneck length	400 mm
Dimensions	115 x 65 x 170 mm (console housing)
Weight	1.1 kg
Connection	2 x 3.5 mm jack 1 x 2 m connection cable with 7-pole DIN plug 1 x 7-pole DIN jack



D7P-10

Order No. 0173370

10 m

D7P-20

Order No. 0173380

20 m

Extension cables

- 7-pole DIN plug to 7-pole DIN jack

Model	D7P-10	D7P-20
Suitable for	CS-1CU, CS-1CH, CS-1DU	CS-1CU, CS-1CH, CS-1DU
Length	10 m	20 m
Weight	624 g	1.32 kg



Automatic Microphone Mixers

of the CS series are THE perfect aid for concepts with multiple microphones, e.g. in conference rooms, houses of worship or language laboratories. The main task of the mixer is to open the respective microphone channel when required and to close it again when the speaker has finished the presentation. This intelligent adjustment for the individual microphone channels

allows for a silent and precise control which ensures that the audience hears every single word. This greatly improves the overall sound resulting in a clear, transparent reproduction and minimises acoustic feedback and irritating background noise. The CS mixers feature a last-in function in order to maintain a pleasant atmosphere with a soft ambient sound also during the

breaks in conversation rather than just cutting off the sound.



CS-8

Order No. 0173550

Automatic microphone mixer

- 8 channels
- 3 operating modes: auto mode, priority or 8/1-channel mixer
- Balanced XLR inputs, switchable mic/line
- Additional stereo RCA input
- 48 V phantom power
- Mix output, switchable mic/line
- Trigger outputs for external devices, e.g. warning devices, cameras or speakers
- Status LEDs

- Several devices can be combined via link connections (supplied with cable)
- Desktop metal housing
- 482 mm (19") rack installation possible with supplied mounting brackets

Model	CS-8
Mic input	0.2 mV/4.7 kΩ
Line input	60 mV/20 kΩ
Aux output	1 V/200 Ω
Frequency range	35-20,000 Hz
THD	< 0.06%
S/N ratio	> 70 dB
Power supply	via encl. plug-in power supply
Dimensions	420 x 44 x 199 mm
Weight	2.3 kg

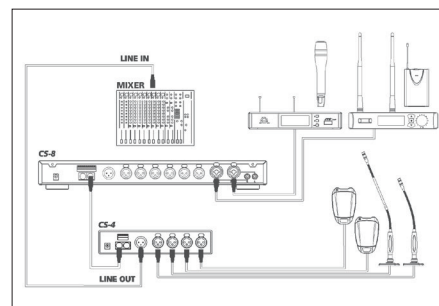
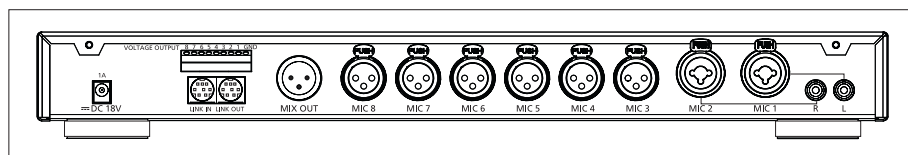

CS-4

Order No. 0173540

Automatic microphone mixer

- 4 channels
- 3 operating modes: auto mode, priority or 4/1-channel mixer
- Balanced XLR inputs, switchable mic/line
- 12 V phantom power
- Mix output, switchable mic/line
- Trigger outputs for external devices, e.g. warning devices, cameras or speakers
- Status LEDs

- Several devices can be combined via link connections (supplied with cable)
- Desktop metal housing
- 482 mm (19") rack installation with supplied mounting brackets

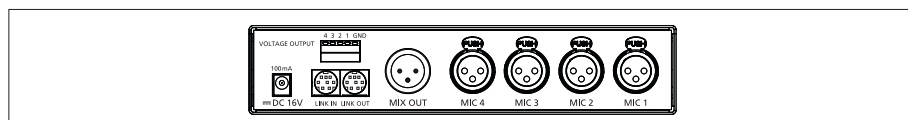

Model	CS-4
Mic input	0.2 mV/4.7 kΩ
Line input	60 mV/20 kΩ
Aux output	1 V/200 Ω
Frequency range	35-20,000 Hz
THD	< 0.06%
S/N ratio	> 70 dB
Power supply	via encl. plug-in power supply
Dimensions	200 x 44 x 212 mm
Weight	1.4 kg



IT-12M

Order No. 0173720

Interpretation system, base unit, for setting up a multilingual interpretation system.

- 12 languages (floor language/main language and 11 translations via interpretation console IT-12D)
- Slow-down signal
- Alarm function, audio message or audio alarm signal can be fed to each output
- Status LEDs for interpretation channels
- Microphone connection via comb. jack on the front panel
- 48 V phantom power supply
- 12 V power supply connections for wireless transmitters TG-10STX/1, available at option
- 482 mm (19") rack installation with supplied mounting brackets

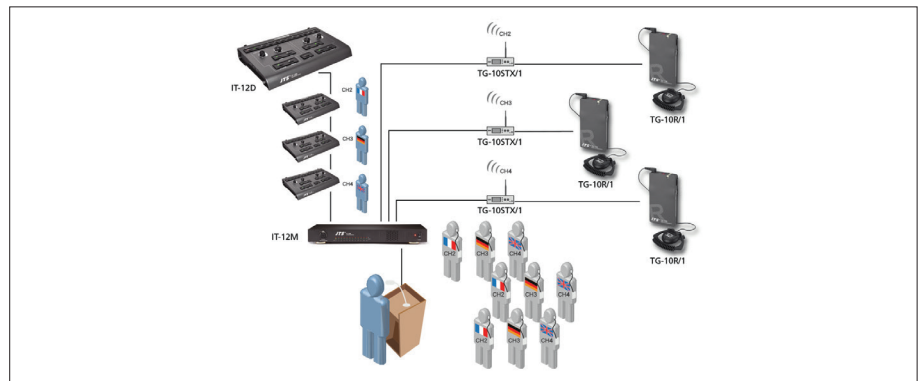

Model	IT-12M
Description	interpretation system, base unit
Type	12 languages
Colour	black
Material	metal
Power supply	~ 230 V/50 Hz/90 VA
Dimensions	423 x 52 x 220 mm
Weight	2.6 kg
Connections	microphone connection (comb. jack), 12 V power supply connections for TG-10STX/1

IT-12D

Order No. 0173710

Interpretation console, as an addition to the base unit IT-12M.

- Up to 11 interpretation consoles can be cascaded
- 2 channels, one of which is active, the other serves as a standby channel
- Interpreting channels can be stored permanently at the console
- Last active channel will be stored after switching off the operating voltage and will be available again immediately after switching on the device
- 2 simultaneous interpreters/commentators to use the active channel at the same time
- Headset connection with volume control
- Microphones can be switched off or muted, cough button
- Balanced XLR jacks for connecting additional microphones
- Relay interpreting via 11-step language selector
- Low-noise push-buttons for switching between relay language and floor language
- Protocol of interpretation via 2 record outputs
- Slow-down button
- Robust and stable metal housing
- Power supply via base unit



Model	IT-12D
Description	interpretation console
Type	2 channels
Colour	black
Material	metal
Suitable for	IT-12M
Power supply	via IT-12M
Dimensions	330 x 56 x 206 mm
Weight	2.3 kg
Connections	headset connection, bal. XLR jacks, record outputs
Packing unit	1

RU-8012DB/5

Order No. 0259420

2-channel diversity UHF PLL wideband receiver

- Bandwidth: 36 MHz
- 6 groups, each with up to 22 compatible preset channels
- 1,441 selectable individual frequencies
- REMOSET ULTRASONIC technology for receiver/transmitter synchronisation
- Removable antennas (BNC connection)
- Auto-scan function
- Pilot tone squelch and noise mute

Model	RU-8012DB/5
Description	receiver unit
Carrier frequency range	506-542 MHz
Audio frequency range	50-16,000 Hz
THD	< 0.6%
Dynamic range	> 105 dB
Audio signal receiver	630 mV/600 Ω XLR (line), 63 mV/600 Ω XLR (mic), 320 mV/600 Ω jack
Power supply receiver	via encl. power supply
Dimensions receiver	210 x 40 x 185 mm
Weight receiver	508 g

There are restrictions or requirements within the EU.

Please read the notes regarding wireless systems in the section "IMPORTANT INFORMATION"!



RU-8011DB/5

Order No. 0259200

Diversity UHF PLL wideband receiver

- Bandwidth: 36 MHz
- 6 groups, each with up to 22 compatible preset channels
- 1,441 selectable individual frequencies
- REMOSET ULTRASONIC technology for receiver/transmitter synchronisation
- Removable antennas (BNC connection)
- Auto-scan function
- Pilot tone squelch and noise mute

Model	RU-8011DB/5
Description	receiver unit
Carrier frequency range	506-542 MHz
Audio frequency range	50-16,000 Hz
THD	< 0.6%
Dynamic range	> 105 dB
Audio signal receiver	630 mV/600 Ω XLR (line), 63 mV/600 Ω XLR (mic), 320 mV/600 Ω jack
Power supply receiver	via encl. power supply
Dimensions receiver	210 x 40 x 185 mm
Weight receiver	457 g

There are restrictions or requirements within the EU.

Please read the notes regarding wireless systems in the section "IMPORTANT INFORMATION"!



RU-8011D/5

Order No. 0259848

Diversity UHF PLL wideband receiver

- Bandwidth: 36 MHz
- 6 groups, each with up to 22 compatible preset channels (114 channels)
- REMOSET ULTRASONIC technology for receiver/transmitter synchronisation
- Auto-scan function
- Pilot tone squelch and noise mute

Model	RU-8011D/5
Description	receiver unit
Carrier frequency range	506-542 MHz
Audio frequency range	60-15,000 Hz
THD	< 0.6%
Dynamic range	> 105 dB
Audio signal receiver	630 mV/600 Ω XLR (line), 63 mV/600 Ω XLR (mic), 320 mV/600 Ω jack
Power supply receiver	via encl. power supply
Dimensions receiver	210 x 40 x 180 mm
Weight receiver	440 g

There are restrictions or requirements within the EU.

Please read the notes regarding wireless systems in the section "IMPORTANT INFORMATION"!



RU-850LTH/5

Order No. 0259560

Dynamic hand-held UHF PLL microphone transmitter

- Bandwidth: 36 MHz
- 6 groups, each with up to 22 compatible preset channels
- 1,441 selectable individual frequencies
- REMOSET ULTRASONIC technology for receiver/transmitter synchronisation
- Lock function/mute function
- Special design to reduce handling noise, structure-borne noise and acoustic feedback
- 5-level display for indicating battery status and low battery alert, backlit LCD
- Switchable transmitting power

Model	RU-850LTH/5
Transmission method	wireless
Polar pattern	cardioid
System	dynamic
Carrier frequency range	506-542 MHz
Transmitting power	10/50 mW
Power supply	2 x batt. AA size, alkaline (not supplied)
Operating time	30 h
Audio frequency range	50-16,000 Hz
Max. sound pressure	148 dB
Dimensions	Ø 51 mm x 269 mm
Weight	242 g

There are restrictions or requirements within the EU.

Please read the notes regarding wireless systems in the section "IMPORTANT INFORMATION"!



RU-850LTB/5

Order No. 0259360

UHF PLL pocket transmitter

- Suitable for combination with a headband microphone or an instrument microphone with 4-pole mini XLR connector
- Bandwidth: 36 MHz
- 6 groups, each with up to 22 compatible preset channels
- 1,441 selectable individual frequencies
- REMOSET ULTRASONIC technology for receiver/transmitter synchronisation
- Selectable sensitivity (± 15 dB); additional 20 dB attenuation can be activated as required
- Lock/mute function
- 5-level display for indicating battery status and low battery alert, backlit LCD
- Switchable transmitting power

Model	RU-850LTB/5
Description	pocket transmitter
Carrier frequency range	506-542 MHz
Audio frequency range	50-16,000 Hz
Operating time	30 h
Transmitting power	10/50 mW
Power supply transmitter	2 x batt. AA size, alkaline (not supplied)
Dimensions transmitter	62 x 97 x 20 mm
Weight transmitter	76 g

There are restrictions or requirements in the EU. Please read the notes regarding wireless systems in the section "IMPORTANT INFORMATION"!



CM-214ULF

Order No. 0236450

Electret headband microphone

- Transparent sound
- Adjustable headband, comfortable to wear
- Highly resistant to acoustic feedback due to cardioid polar pattern
- Replaceable connection cable
- Flexible cartridge arm for exact positioning of cartridge, thus providing an optimum sound with an unobtrusive appearance
- Connection cable with strain relief, screwed-on
- Integr. drip ring protects the cartridge from moisture

Model	CM-214ULF
Polar pattern	cardioid
System	electret
Audio frequency range	100-18,000 Hz
Nominal impedance	1.5 k Ω
Sensitivity	1.8 mV/Pa
Max. sound pressure	120 dB
Power supply	pocket transmitter IN/PT/UF series or PS-500
Weight	44 g

- Supplied with a 4-pole mini XLR connection cable for connection to pocket transmitters of the IN/PT/UF series
- Connection cable 801TG with right-angle 3.5 mm plug for use with our tour guide systems is available at option
- Supplied with bag and windshield

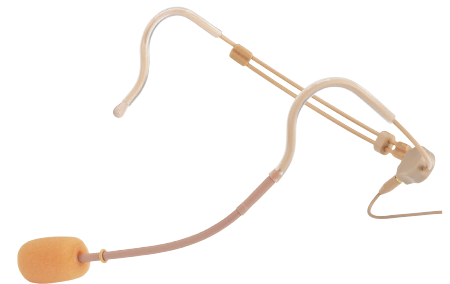

CM-801F

Order No. 0235900

Electret earband microphone

- Ultra-light earband microphone for stage and podium
- Optimum speech intelligibility
- Movable drip ring
- Screwed-on cable, easy to replace
- Clip for strain relief, makes microphone more comfortable to wear and enhances stable positioning
- Connection cable 801TG with right-angle 3.5 mm plug for use with our tour guide systems is available at option
- Supplied with bag and windshield

Model	CM-801F
Polar pattern	omnidir.
System	electret
Audio frequency range	60-15,000 Hz
Nominal impedance	1.8 k Ω
Sensitivity	6.3 mV/Pa
Max. sound pressure	130 dB
Power supply	pocket transmitters of the IN/PT/UF series or PS-500
Weight	16 g



801C3

Order No. 0236120

Connection cable

- Beige (801C3) or black (801C3/B) version
- 3-pole mini XLR connector
- Length: 150 cm
- Suitable for CM-801F, CM-804IF, CM-214F, CM-214ULF and CM-235IF, CM-235IB



PT-RMS

Order No. 0236870

External mute button (cough button)

- For tie clip microphones and headband microphones from JTS
- Selectable switching mode (ON/OFF, momentary ON, momentary OFF)
- 4-pole mini XLR connection
- Compatible with any pocket transmitter from JTS



UF-20R/5

Order No. 0257210



2-channel true diversity UHF PLL wideband receiver

- Bandwidth: 75 MHz
- 15 groups, each with 63 compatible preset channels
- 64 channels in 6 groups from 3,000 selectable individual frequencies can be stored in user presets
- RF output and mains voltage output for easily cascading up to 10 x UF-20R/5 receiver without additional splitter
- REMOSET technology for receiver/transmitter synchronisation
- Auto-scan function
- Pilot tone and noise squelch
- Equalizer function
- LED for indicating RF level and AF level

- Backlit display for indicating battery status of the transmitter, frequency setup, active antenna
- Metal housing
- Power supply for optional antenna booster UB-900I directly via antenna inputs

There are restrictions or requirements within the EU. Please read the notes regarding wireless systems in the section "IMPORTANT INFORMATION"!



Model	UF-20R/5
Description	wireless receiver
Carrier frequency range	530-605 MHz
Audio frequency range	50-18,000 Hz
THD	< 0.5%
Dynamic range	> 108 dB
Audio signal receiver	100 mV XLR, 100 mV jack
Power supply receiver	~ 100-240 V/50-60 Hz/25 VA
Dimensions receiver	480 x 44 x 214 mm
Weight receiver	2.9 kg

UF-20S/5

Order No. 0257220

Single-channel true diversity UHF PLL wideband receiver

- Bandwidth: 75 MHz
- 15 groups, each with up to 63 compatible preset channels
- 64 channels in 6 groups from 3,000 selectable individual frequencies can be stored in user presets
- REMOSET technology for receiver/transmitter synchronisation
- Auto-scan function
- Pilot tone and noise squelch
- Equalizer function
- LED for indicating RF level and AF level
- Backlit display for indicating battery status of the transmitter, frequency setup, active antenna
- Metal housing

- Power supply for optional antenna booster UB-900I directly via antenna inputs

There are restrictions or requirements within the EU. Please read the notes regarding wireless systems in the section "IMPORTANT INFORMATION"!



Model	UF-20S/5
Description	wireless receiver
Carrier frequency range	530-605 MHz
Audio frequency range	50-18,000 Hz
THD	< 0.5%
Dynamic range	> 108 dB
Audio signal receiver	100 mV XLR, 100 mV jack
Power supply receiver	via encl. power supply
Dimensions receiver	212 x 44 x 214 mm
Weight receiver	1.4 kg

JSS-20/5

Order No. 0257200

Dynamic hand-held UHF PLL transmitter

- Dynamic microphone cartridge (cardioid polar pattern) with minimised feedback susceptibility as well as suppression of handling noise/structure-borne noise
- Bandwidth: 75 MHz
- 15 groups, each with up to 63 compatible preset channels
- 64 channels in 6 groups from 3,000 selectable individual frequencies can be stored in user presets
- REMOSET technology for receiver/transmitter synchronisation
- Adjustable sensitivity (-15 dB to +15 dB)

- Lock function/mute function
- 5-level display for indicating battery status and low battery alert, backlit LCD
- Switchable transmitting power
- Supplied with robust transport case, stand clamp and 8 ID caps

There are restrictions or requirements within the EU. Please read the notes regarding wireless systems in the section "IMPORTANT INFORMATION"!

Model	JSS-20/5
Polar pattern	cardioid
System	dynamic
Carrier frequency range	530-605 MHz
Transmitting power	10/50 mW
Power supply	2 x batt. AA size, alkaline (not supplied)
Operating time	> 20 h
Dimensions	Ø 50 mm x 260 mm
Weight	340 g



UF-20TB/5

Order No. 0257230

UHF PLL pocket transmitter

- Suitable for combination with a headband microphone or an instrument microphone with 4-pole mini XLR connector
- Bandwidth: 75 MHz
- 15 groups, each with up to 63 compatible preset channels
- 64 channels in 6 groups from 3,000 selectable individual frequencies can be stored in user presets
- REMOSET technology for receiver/transmitter synchronisation
- Adjustable sensitivity (-18 dB to +12 dB)
- Lock function
- 5-level display for indicating battery status and low battery alert, backlit LCD
- Switchable transmitting power

Model	UF-20TB/5
Description	pocket transmitter
Carrier frequency range	530-605 MHz
Audio frequency range	50-18,000 Hz
Operating time	> 20 h
Transmitting power	10/50 mW
Power supply transmitter	2 x batt. AA size (not supplied)
Dimensions transmitter	62 x 170 x 23 mm
Weight transmitter	90 g

There are restrictions or requirements within the EU.

Please read the notes regarding wireless systems in the section "IMPORTANT-INFORMATION"!



CH-8

Order No. 0259410

Transport case with integrated charging function

for transmitters UF-20TB/5, JSS-20/5, JSS-4B/5, R-4TBM/5 and RU-G3TB/5.

- For simultaneously charging rech. batteries of 8 devices
- Average charging time, depending on capacity and condition of rech. batteries used: approx. 3 hours
- Each slot with LED for indicating a fault and battery charging status
- Mechanical reverse polarity protection
- Protection against overload, short-circuit and deep discharge

Model	CH-8
Description	transport case with integrated charging function
Colour	black
Suitable for	transmitters UF-20TB/5, JSS-20/5, JSS-4B/5, R-4TBM/5, RU-G3TB/5
Power supply	via encl. power supply
Dimensions	357 x 294 x 433 mm
Weight	11.6 kg

- Power is provided via supplied power supply
- Dimensions: 357 x 294 x 433 mm

Supplied w/o devices.



CH-2

Order No. 0257240

Charging station, for transmitters UF-20TB/5, JSS-20/5, JSS-4B/5, R-4TBM/5 and RU-G3TB/5.

- For simultaneously charging rech. batteries of 2 devices
- Average charging time, depending on condition of rechargeable batteries used: approx. 3 hours
- Each slot with LED for indicating a fault and battery charging status
- Mechanical reverse polarity protection
- Protection against overload, short-circuit and deep discharge
- Power is provided via enclosed power supply

Model	CH-2
Description	charging station
Colour	black
Suitable for	transmitters UF-20TB/5, JSS-20/5, JSS-4B/5, R-4TBM/5, RU-G3TB/5
Power supply	via enclosed power supply
Dimensions	165 x 72 x 99 mm
Weight	315 g

- Dimensions: 165 x 72 x 99 mm



MA-935

Order No. 0236850

Adapter ring

- For mounting dynamic microphone cartridges from Sennheiser to hand-held UHF PLL transmitters JSS-20/5 and JSS-4B/5
- Aluminium version
- Screw thread



R-4/5

Order No. 0259400



4-channel diversity UHF PLL wideband receiver

- Bandwidth: 36 MHz
- 6 groups, each with up to 22 compatible preset channels
- 1,441 selectable individual frequencies
- RF output and mains voltage output for easily cascading up to 10 x R-4/5 receiver without additional splitter
- REMOSET technology for receiver/transmitter synchronisation
- Auto-scan function
- Pilot tone squelch and noise mute
- LED for indicating RF level and AF level
- Backlit display for indicating battery status of the transmitter, frequency setup, active antenna

- XLR output per channel, bal.
- XLR output and 6.3 mm output for mixed signal
- Switchable mic/line for single outputs and mixed outputs
- Metal housing

There are restrictions or requirements within the EU. Please read the notes regarding wireless systems in the section "IMPORTANT INFORMATION"!



Model	R-4/5
Description	wireless receiver
Carrier frequency range	506-542 MHz
Audio frequency range	50-18,000 Hz
THD	< 0.6%
Dynamic range	> 105 dB
Audio signal receiver	630 mV/600 Ω XLR (line), 63 mV/600 Ω XLR (mic), 320 mV/600 Ω jack
Power supply receiver	~ 100-240 V/50-60 Hz
Dimensions receiver	485 x 44 x 230 mm
Weight receiver	2.65 kg

JSS-4B/5

Order No. 0259390

Dynamic hand-held UHF PLL transmitter

- Dynamic microphone cartridge (cardioid polar pattern) with wide dynamic range
- Aluminium housing
- Bandwidth: 36 MHz
- 6 groups, each with up to 22 compatible preset channels
- 1,441 selectable individual frequencies
- REMOSET technology for receiver/transmitter synchronisation
- Adjustable sensitivity (-15 dB to +15 dB)
- Lock/mute function
- 4-level display for indicating battery status and low battery alert, backlit LCD

- Switchable transmitting power

There are restrictions or requirements within the EU. Please read the notes regarding wireless systems in the section "IMPORTANT INFORMATION"!



Model	JSS-4B/5
Polar pattern	cardioid
System	dynamic
Carrier frequency range	506-542 MHz
Transmitting power	10/50 mW
Power supply	2 x batt. AA size, alkaline (not supplied)
Audio frequency range	50-18,000 Hz
Max. sound pressure	150 dB
Housing material	aluminium
Dimensions	Ø 50 mm x 253 mm
Weight	335 g

R-4THA/5

Order No. 0259847

Hand-held UHF PLL transmitter, with condenser cartridge.

- Condenser microphone cartridge (cardioid polar pattern)
- Bandwidth: 36 MHz
- 6 groups, each with up to 22 compatible preset channels
- 1,441 selectable individual frequencies
- REMOSET technology for receiver/transmitter synchronisation
- Adjustable sensitivity (± 15 dB)
- Lock function/mute function
- 4-level display for indicating battery status and low battery alert, backlit LCD
- Switchable transmitting power

There are restrictions or requirements within the EU. Please read the notes regarding wireless systems in the section "IMPORTANT INFORMATION"!



Model	R-4THA/5
Polar pattern	cardioid
System	condenser
Carrier frequency range	506-542 MHz
Transmitting power	10/50 mW
Power supply	2 x batt. AA size, alkaline (not supplied)
Operating time	> 20 h
Audio frequency range	50-18,000 Hz
Max. sound pressure	140 dB
Dimensions	Ø 50 mm x 253 mm
Weight	260 g

R-4TBM/5

Order No. 0259841

UHF PLL pocket transmitter

- Suitable for combination with a headband microphone or an instrument microphone with 4-pole mini XLR connector
- Bandwidth: 36 MHz
- 6 groups, each with up to 22 compatible preset channels
- 1,441 selectable individual frequencies
- REMOSET technology for receiver/transmitter synchronisation
- Adjustable sensitivity (± 15 dB)
- Lock function
- 6-level display for indicating battery status and low battery alert, backlit LCD
- Switchable transmitting power

There are restrictions or requirements within the EU.

Please read the notes regarding wireless systems in the section "IMPORTANT INFORMATION"!

Model	R-4TBM/5
Description	pocket transmitter
Carrier frequency range	506-542 MHz
Audio frequency range	50-18,000 Hz
Operating time	> 20 h
Transmitting power	10/50 mW
Operating range	120 m
Power supply transmitter	2 x batt. AA size (not supplied)
Dimensions transmitter	62 x 80 x 23 mm
Weight transmitter	95 g



850CH-2

Order No. 0259370

Charging station, for transmitters RU-850LTH/5, RU-850LTB/5 and R-4THA/5.

- For simultaneously charging rech. batteries of 2 devices
- Average charging time, depending on condition of rechargeable batteries used: approx. 5 hours
- Each slot with LED for indicating a fault and battery charging status
- Mechanical reverse polarity protection
- Protection against overload, short-circuit and deep discharge
- Power is provided via enclosed power supply

Supplied w/o devices.

Model	850CH-2
Description	charging station
Colour	black
Suitable for	transmitters RU-850LTH/5, RU-850LTB/5, R-4THA/5
Power supply	via encl. power supply
Dimensions	165 x 72 x 99 mm
Weight	329 g



Other systems can be found at IMG STAGELINE.

YOUR MOMENT –
CAPTURED BY
IMG STAGELINE

www.img-stageline.com

IMG
STAGELINE

UDA-49A

Order No. 0150630

Active UHF directional antenna

- Improved reception and a larger transmission range of 470-960 MHz
- Rejects unwanted RF signals, minimises signal loss in multipath receptions and reduces interference susceptibility
- Reliable operation also for short-term outdoor use
- Switchable gain (3 dB/10 dB) to avoid power loss
- Remote power supply: = 12 V/50 mA
- BNC connection
- Power supply via UHF PLL receivers of the US/IN series or the active antenna splitter UA-960

Model	UDA-49A
Frequency range	470-960 MHz
Aperture angle	100°
Antenna gain	≥ 10 dB
Power supply	= 12 V/50 mA, remote power supply (external power supply)
Impedance level	50 Ω
Support	9 mm (3/8") or 16 mm (5/8")
Dimensions	360 x 350 x 36 mm (sheet thickness: 1.7 mm)
Weight	350 g

- Ideally suited for mobile applications, can be mounted onto any microphone stand with 9 mm (3/8") or 16 mm (5/8") thread

2 x UDA-49A required for diversity reception.



UDA-49P

Order No. 0150640

Passive UHF directional antenna

- For wireless microphone systems (reception antenna) or for wireless in-ear monitoring systems, e.g. SIEM-111/5 from JTS (transmitting antenna)
- Improved reception and a larger transmission range of 470-960 MHz
- Rejects unwanted RF signals, minimises signal loss in multipath receptions and reduces interference susceptibility
- Reliable operation also for short-term outdoor use
- BNC connection (for UHF PLL receivers of the US/IN series or active antenna splitter UA-960)

Model	UDA-49P
Frequency range	470-960 MHz
Aperture angle	100°
Antenna gain	≥ 10 dB
Impedance level	50 Ω
Support	9 mm (3/8") or 16 mm (5/8")
Dimensions	360 x 350 x 36 mm (sheet thickness: 1.7 mm)
Weight	350

- Ideally suited for mobile applications, can be mounted onto any microphone stand with 9 mm (3/8") or 16 mm (5/8") thread

2 x UDA-49P required for diversity reception.



ANT-49

Order No. 0150810

Passive UHF wideband omnidirectional antenna

- For wireless microphone systems or wireless in-ear monitoring systems
- Consistent RF power supply, independent of direction
- Ideally suited for mobile applications, can be mounted onto microphone stand with 9 mm (3/8") or 16 mm (5/8") thread

Model	ANT-49
Frequency range	470-960 MHz
Aperture angle	360°
Antenna gain	2-4 dB
Impedance level	50 Ω
Support	9 mm (3/8") or 16 mm (5/8")
Dimensions	130 x 255 x 32 mm (sheet thickness: 2 mm)
Weight	205 g

2 x ANT-49 required for diversity reception.



USP-900

Order No. 0150650

Passive UHF antenna splitter/UHF combiner

- For minimising the great effort and expense of antennas for wireless receiver systems or transmission systems
- Splits the antenna input signal into two antenna output signals
- 2 x USP-900 required for commonly supplying two diversity receivers set up with two antennas respectively

Model	USP-900
Frequency range	10-1,000 MHz
Launch attenuation	2 dB
Decoupling	20 dB
Impedance level	50 Ω
Connection	3 x BNC jack
Dimensions	72 x 24 x 56 mm
Weight	63 g

- DC suppression
- Can also be used as a combiner in order to operate 2 x SIEM-111/5 with one antenna



UA-960

Order No. 0150820



Active antenna splitter

- For operating up to four UHF PLL receivers of the UF/US/IN series with one pair of antennas
- With this device, it is not longer required to use the respective antennas and plug-in power supplies of the individual devices
- Frequency range: 470-960 MHz
- Power supply via four low-voltage outputs (4 x = 12 V/1 A max.)
- Each antenna to be connected via BNC jacks
- Additional connection for cascading further antenna splitters



- Supplied with suitable connection cables
- Power supply for optional antenna booster UB-9001 directly via UA-960 (can be deactivated internally)

Model	UA-960
Frequency range	470-960 MHz
Connection	BNC
Power supply	~ 100-240 V/50-60 Hz/60 W
Dimensions	482 x 45 x 250 mm, 1 RU
Weight	2.15 kg

UC-900

Order No. 0150580



4-way antenna combiner

- Range of applications:
 - Signals of up to four in-ear monitoring transmitters, e.g. SIEM-111/..., can be sent via one antenna
 - Signals of up to four antennas which are positioned at a certain distance from each other can be combined for extending the reception area of a stationary receiver
- Frequency range: 470-960 MHz
- Gain: 0 dB, ±2 dB
- Maximum RF power for each input: +20 dBm (100 mW)



- Low-voltage outputs: 4 x = 12 V, 1 A max. for supplying operating voltage directly to connected devices
- Each antenna to be connected via BNC jacks
- Supplied with suitable connection cables

Model	UC-900
Frequency range	470-960 MHz
Antenna gain	0 dB, ±2 dB
Power supply	~ 100-240 V/50-60 Hz/40 VA
Dimensions	482 x 44.8 x 260 mm
Weight	2.3 kg
Connection	4 x BNC, 4 x low-voltage jack

USP-124

Order No. 0150860

4-way antenna splitter

- For operating up to four antennas with one transmitter (e.g. SIEM-111/5)
- Frequency range: 470-960 MHz
- Gain: 0 dB, ± 2 dB
- All connections via BNC jacks



Model	USP-124
Frequency range	470-960 MHz
Antenna gain	0 dB, ±2 dB
Power supply	via encl. power supply
Dimensions	212 x 44 x 203 mm
Weight	350 g
Connection	BNC

UB-900I

Order No. 0150830

Antenna booster, for UHF PLL receivers.

- Power supply via UHF PLL receivers of the UF/US series and IN series or via active antenna splitter UA-960
- DC feed-through output for cascading up to 2 x UB-900I max.
- Ideally suited for mobile applications, can be mounted onto microphone stand with 16 mm (5/8") thread

Diversity operation: one booster is required for each antenna connected!



RP-900

Order No. 0230540

Mounting plate, for offset antenna mounting.

- Black lacquered metal version
- Dimensions: 227 x 44 x 1.6 mm, 1 RU



DR-900SET

Order No. 0244770



482 mm (19", 1 RU) device holder

- For installing up to two half-rack sized receivers into one 482 mm (19") rack
- Partly profiled sheet steel for on-the-road applications and secure support
- The supplied 241 mm (9.5") rack panel with screws can cover the unrequired mounting space



RTF-20

Order No. 0252060

Coaxial antenna cable, with mounting plate.

- 2 x 20 m RG-58U coaxial cable with 2 x BNC plug each, e.g. for connecting

offset antennas to respective UHF PLL receivers of the UF/US/IN series or in-ear monitoring transmitter SIEM-111/R

- Mounting plate (1 RU) with punched holes for two supplied BNC bushings

Model	RTF-20
Intended use	coaxial antenna cable
Connectors	2 x BNC plug
Length	20 m
Colour	black
Cable diameter	5 mm
Shielding value	20 dB @ 100 MHz
Impedance	50 Ω
Attenuation	7 dB
Special feature	1 RU mounting plate: 227 x 44 x 1.6 mm
Other features	frequency range: 10-1,000 MHz



RTF-2U

Order No. 0230530



Model	RTF-2U
Size	for 482 mm (19")
Colour	black
Weight	105 g (pair)

Mounting bracket set, for offset antenna mounting.

- For 482 mm (19") rack installation
- Consisting of:
 - 2 x mounting bracket
 - 2 x BNC jack
 - 2 x 40 cm antenna cable with BNC plug



RTF-1

Order No. 0230550

Coaxial antenna cable, with mounting plate.

- 2 x 0.6 m RG-58U coaxial cable with 2 x BNC plug each, e.g. for connecting offset antennas to respective UHF PLL receivers of the UF/US/IN series or in-ear monitoring transmitter SIEM-111/R
- Mounting plate (1 RU) with punched holes for two supplied BNC bushings



RTF-3

Order No. 0230560



BNC antenna cable

- 50 Ω
- 2 x BNC plug
- Length: 2 x 3 m
- 2 x BNC bushing

Model	RTF-1
Intended use	coaxial antenna cable
Connectors	2 x BNC plug
Length	60 cm
Colour	black
Shielding value	20 dB @ 100 MHz
Impedance	50 Ω
Special feature	1 RU mounting plate: 227 x 44 x 1.6 mm
Other features	frequency range: 10-1,000 MHz

RM-901

Order No. 0254940



482 mm (19") mounting brackets

- For mounting CS-4, CS-8, SIEM-111/... (transmitter), TG-10STX/1 or UF-20S/5 into a rack cabinet
- Metal version



RM-10SET

Order No. 0254950

482 mm (19") mounting set

- For mounting two SIEM-111/... (transmitter), UF-10R/12 or UF-20S/5 into a rack cabinet
- Consisting of two metal mounting brackets and two aluminium connecting rails

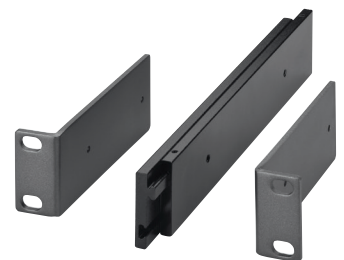

The SPEECH-500 is a professional solution

which is equipped with innovative technology and suitable for music transmissions of high requirements. The lectern features a variable electric height adjustment. A laptop can space-savingly be accommodated underneath the transparent glass plate on the top part of the lectern in a 2-step illuminated compartment which has especially been designed for this purpose. The built-in audio system as well as the UHF PLL wireless technology with transmitter module and receiver module perfectly meet every requirement. In audio link operation, this allows for a wireless control of further active speaker systems which are equipped with respective wireless receivers, e.g. TXA-800 and TXA-1000 series.

SPEECH-500/GR

Order No. 0176210

Professional lectern with electric height adjustment and integrated wireless amplifier system

- Built-in 4-channel mixing amplifier with limiter, 50 W
- Variable electric height adjustment of the lectern, 85-125 cm
- Top part of the lectern with a transparent safety glass plate and illuminated compartment for a laptop
- Built-in UHF PLL receiver (TXA-1822MR) with 2 x 16 selectable frequencies (863.1-864.9 MHz) with diversity system, matching transmitters are available at option, e.g. TXA-800HSE or TXA-800HT
- Built-in UHF PLL transmitter (TXA-820MT) with 16 selectable frequencies (863.1-864.9 MHz) for setting up audio link transmission
- 3 inputs via comb. jack mic (XLR)/line (6.3 mm jack), stereo line input (RCA), gain controls, 3-way equalizer for the comb. inputs
- 2 shock-absorbing XLR jacks on the top part of the lectern for 2 optional gooseneck microphones (each one uses a microphone input), matching microphone EMG-650P is available at option
- Additional XLR jack for LED gooseneck light (e.g. GNL-453XLR, available at option)
- 24 V phantom power for mic input 1 and 2
- 1 stereo line output via RCA jacks
- 2-way speaker system with 30 cm (12") bass speaker and horn tweeter (1")
- High-quality wooden cabinet, wood and lacquer combination
- Standard wood decor: grey lacquered
- Holder for name of speaker to be mounted with terminal screw

- 3 additional storage compartments for documents and other utensils
- 2 swivel castors with locking brakes, 2 fixed castors

Licence-free in the EU.

Supplied w/o laptop.

Also available in the colours:

In addition to the standard wood decor grey lacquered, you can choose your individual colour or desired wood decor from 20 other design options: Maple, Dark Apple, Beech, Dark Beech, Italian Oak, Red Oak, Rustic Oak, Alder, Cherry, Dark Cherry, Light Cherry, Tobacco Acacia, Dark Walnut, Light Walnut, Wenge, Plum, Apricot, Pigeon Blue, Vanilla, grey (standard) and white.

Information on delivery times and extra charges upon request.



Model	SPEECH-500/GR
Rated power (P _{RMS})	50 W
Peak output power	100 W
Frequency range	50-20,000 Hz
Carrier frequency	863.1-864.9 MHz
Operating range	≤ 30 m
Inputs	24 mV (mic 1-2, top), 4.5 mV (mic 1-3), 150 mV (line 1-3), 400 mV (line)
Equalizer, bass	± 12 dB/60 Hz
Equalizer, midrange	± 7 dB/1 kHz
Equalizer, treble	± 12 dB/15 kHz
Power supply	~ 230 V/50 Hz/135 VA
Dimensions	800 x 850-1,250 x 570 mm
Weight	52 kg
Connections	3 x XLR (mic), 3 x 6.3 mm jack (line), 1 x RCA L/R (line in), 1 x RCA L/R (line out)



Set up, connect and go: audio lectern for multimedia presentations

The SPEECH-204 is an efficient and portable lectern with built-in mixing amplifier and integrated speaker system in 2-way technology. The elaborate functionality and high sound quality ensure a successful and professional performance and thus contribute to the success of every event. The SPEECH-204 is set up and ready for use in no time and ideally suited for multimedia presentations in hotels, houses of worship, conference rooms and convention centres.

SPEECH-204

Order No. 0179130

Professional lectern with integrated 2-channel multifrequency receiver unit with UHF PLL technology

- Built-in high-performance mixing amplifier and speaker system, 75 W
- 2 x 16 selectable UHF frequencies (863.1-864.9 MHz)
- Integrated limiter
- 3 inputs via comb. jack mic (XLR)/line (6.3 mm jack) with 3-way equalizer and gain control
- 1 stereo line input via RCA jacks with gain control
- 2 shock-absorbing XLR jacks on the top part of the lectern for 2 optional gooseneck microphones (use one microphone input each), with phantom power
- 1 stereo line output via RCA jacks
- 2-way speaker system
- Integrated light in the top part of the lectern
- Column with 2 document compartments and 2 storage compartments
- 2 castors

Supplied w/o gooseneck microphone. Matching microphone EMG-650P is available at option.

Matching microphone transmitters or pocket transmitters are available at option, e.g. TXA-800HSE or TXA-800HT.

Licence-free in the EU.

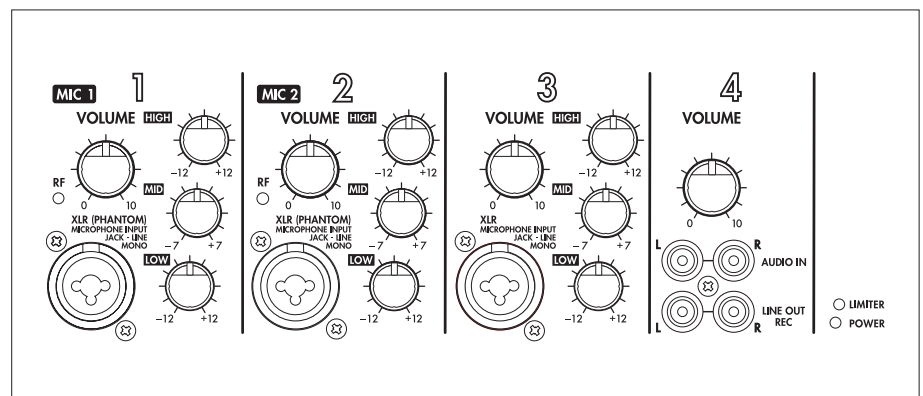

Model	SPEECH-204
Rated power (P_{RMS})	75 W
Peak output power	100 W
Frequency range	60-20,000 Hz
Carrier frequency	863.1-864.9 MHz
Operating range	≈ 25 m
Inputs	15 mV (mic 1), 5 mV (mic 2-3), 220 mV (line 1-3), 250 mV (line)
Equalizer, bass	±12 dB/60 Hz
Equalizer, midrange	±7 dB/1 kHz
Equalizer, treble	±12 dB/15 kHz
Power supply	~ 230 V/50 Hz/180 VA
Dimensions	540 x 1140 x 430 mm
Weight	33 kg
Connections	3 x XLR (mic), 3 x 6.3 mm jack (line), 1 x RCA L/R (line in), 1 x RCA L/R (line out)



An Innovative and High-quality Solution for PA Speech and Music Applications of High Requirements:

The active lectern SPEECH-104D from MONACOR perfectly combines sound quality, volume capability and a convenient operation. It is battery-operated and thus perfectly suitable for mobile applications. The SPEECH-104D turns any area of PA application into an auditorium all by itself. It also fits perfectly into any surrounding area where a temporary or permanent talking point is required.

The integrated amplifier technology and speaker technology not only allow for voice transmissions, but can also easily be used for music reproductions and e.g. dubbings of films or presentations with quite good results. Simply plug-in a gooseneck microphone and/or connect a signal source - switch on - ready to use.

SPEECH-104D

Order No. 0179120

Professional lectern with integrated 2-channel multifrequency receiver unit with UHF PLL technology and class D amplifier

- Built-in class D mixing amplifier and speaker system, 80 W
- Operation via built-in rech. lead gel batteries: 2 x 12 V/7 Ah (operating time: up to 16 hours)
- Integrated battery charging, supplied with charger
- 2 x 16 selectable UHF frequencies (863.1-864.9MHz)
- 1 input via comb. jack mic (XLR)/line (6.3 mm jack)
- 1 stereo aux input via RCA jacks
- Each input with gain control
- 2 shock-absorbing XLR jacks on the top part of the lectern for 2 optional gooseneck microphones (use one microphone input each) or one microphone and one optional LED gooseneck light
- 12 V phantom power
- 1 stereo line output via RCA jacks
- NEUTRIK SPEAKON connection (8 Ω) for external speaker

- 2-way speaker system
- High-quality wooden cabinet with replaceable black bottom plates
- Top part of the lectern with folding document compartment
- Delivery consists of 2 boxes

Supplied w/o gooseneck microphone and w/o gooseneck lamp. Matching microphone EMG-650P and matching LED gooseneck lamp GNL-453XLR are available at option.

Matching microphone transmitters or pocket transmitters are available at option, e.g. TXA-800HSE, TXA-800HT.

Licence-free in the EU.



Model	SPEECH-104D
Rated power (P _{RMS})	80 W
Peak output power	120 W
Frequency range	70-20,000 Hz
Carrier frequency	863.1-864.9 MHz
Operating range	≈ 25 m
Inputs	2 mV (mic 1), 13 mV (line), 20 mV (mic 2-3), 100 mV (aux)
Power supply	rech. batt. 2 x 12 V/7 Ah, = 12 V/1.5 A via encl. charger
Dimensions	525 x 1,120 x 440 mm
Weight	30 kg
Connections	1 x XLR (mic 1) 1 x 6.3 mm jack (line), 2 x XLR (mic 2-3), 1 x RCA L/R (aux), 1 x RCA L/R (line out), 1 x NEUTRIK SPEAKON (ext. speakers)

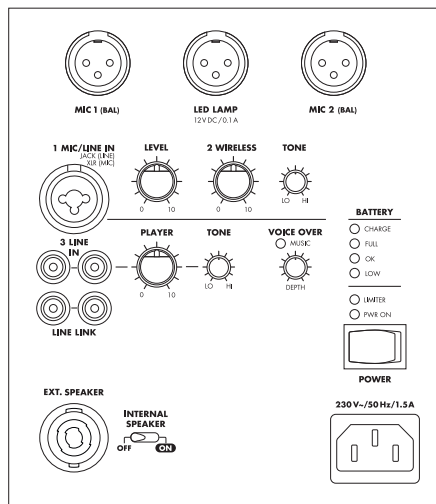

XLR-703JSM

Order No. 0348810

Shock-mount base with XLR socket

- Attenuation of impact noise and structure-borne noise due to rubber-cushioned 3-pole XLR socket
- 1.2 m connection cable with 3-pole XLR plug



FGM-170T

Order No. 0231920



Microphone floor stand, with carbon fibre boom.

- High-quality condenser microphone cartridge with 1.25 cm (1/2") extra thin gold-plated diaphragm, cardioid polar pattern and excellent sound characteristics
- Low cut switch (80 Hz)
- 10 dB attenuation, switchable
- Extra lightweight (105 g) but very robust carbon fibre boom (1.46 m) with miniature gooseneck
- Long shaft, for overhead miking
- Structure-borne noise isolated diecast base plate
- Replaceable cartridge unit and cartridge (plug-in system with screw-type locking)
- Supplied with windshield
- Delivery consists of 2 boxes

Model	FGM-170T
Polar pattern	cardioid
System	condenser
Audio frequency range	20-20,000 Hz
Nominal impedance	100 Ω
Sensitivity	15.8 mV/Pa
Max. sound pressure	140 dB
Power supply	≈ 48 V, phantom power
Dimensions	1.46 m (boom) 1.6 m (stand)
Weight	3.4 kg
Connection	3-pole XLR plug, bal.



FGM-170

Order No. 0236070



Floor stand microphone, with carbon fibre boom.

- 3 high-quality back electret microphone cartridges with different polar patterns
- Low cut switch (80 Hz)
- 10 dB attenuation, switchable
- Extra lightweight (105 g) but very robust carbon fibre boom (1.46 m) with miniature gooseneck
- Long shaft, for overhead miking
- Structure-borne noise isolated diecast base plate
- Supplied with 2 replacement cartridges, connection cable and windshield
- Delivery consists of 2 boxes

Model	FGM-170
Polar pattern	cardioid, supercardioid, omnidir.
System	back electret
Audio frequency range	50-18,000 Hz
Nominal impedance	220 Ω
Sensitivity	16 mV/Pa
Max. sound pressure	125 dB
Power supply	≈ 12-48 V, phantom power
Dimensions	1.46 m (boom) 1.6 m (stand)
Weight	3.6 kg
Connection	cable with 3-pole mini XLR to XLR



CM-502

Order No. 0234580

CM-502WT

Order No. 0233990

Overhead hanging electret microphones

- For suspended installations, especially suitable for applications in which a direct microphonic effect is undesired for optical or operational reasons, e.g. sound pickup of choirs or on theatre stages or school stages
- Microphone cartridge with supercardioid polar pattern
- Integrated phantom power supply adapter
- Easy installation and alignment due to supplied mounting plate for ceiling suspension and spring holder
- Supplied with windshield

CM-502WT: white version

Model	CM-502	CM-502WT
Polar pattern	supercardioid	supercardioid
System	electret	electret
Audio frequency range	100-18,000 Hz	100-18,000 Hz
Nominal impedance	220 Ω	220 Ω
Sensitivity	4 mV/Pa	4 mV/Pa
Max. sound pressure	125 dB	125 dB
Power supply	≈ 12-48 V, phantom power	≈ 12-48 V, phantom power
Housing material	metal	metal
Weight	190 g	190 g
Cable	7.5 m	7.5 m
Connection	XLR, bal.	XLR, bal.

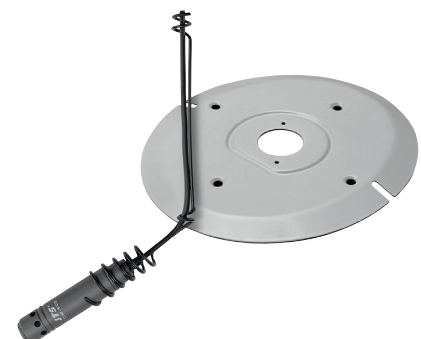

CM-502G6B

Order No. 0233950

CM-502G6W

Order No. 0233960

CM-502G12B

Order No. 0233970

CM-502G12W

Order No. 0233980

Overhead hanging electret microphone

- For suspended installations, especially suitable for applications in which a direct microphonic effect is undesired for optical or operational reasons, e.g. sound pickup of choirs or on theatre stages or school stages
- Microphone cartridge with supercardioid polar pattern
- Integrated phantom power supply adapter
- Flexible alignment due to gooseneck
- Easy-to-replace cartridge unit
- Black (CM-502G...B) or white (CM-502G...W) version
- Supplied with windshield

Total length:

CM-502G6...: 180 mm

CM-502G12...: 320 mm



Model	CM-502G6B	CM-502G6W	CM-502G12B	CM-502G12W
Polar pattern	supercardioid	supercardioid	supercardioid	supercardioid
System	electret	electret	electret	electret
Audio frequency range	100-18,000 Hz	100-18,000 Hz	100-18,000 Hz	100-18,000 Hz
Nominal impedance	220 Ω	220 Ω	220 Ω	220 Ω
Sensitivity	4 mV/Pa	4 mV/Pa	4 mV/Pa	4 mV/Pa
Max. sound pressure	125 dB	125 dB	125 dB	125 dB
Power supply	= 48 V, phantom power	= 48 V, phantom power	= 48 V, phantom power	= 48 V, phantom power
Housing material	metal	metal	metal	metal
Weight	100 g	100 g	145 g	145 g
Cable	8 m	8 m	8 m	8 m
Connection	XLR, bal.	XLR, bal.	XLR, bal.	XLR, bal.

CM-22G6B

Order No. 0235990

CM-22G6W

Order No. 0233920

CM-22G12B

Order No. 0233930

Overhead hanging condenser microphones

- For suspended installations, especially suitable for applications in which a direct microphonic effect is undesired for optical or operational reasons, e.g. sound pickup of choirs or on theatre stages or school stages
- High-quality condenser microphone cartridge with 1.25 cm (1/2") extra thin gold-plated diaphragm, cardioid polar pattern
- Low cut switch (80 Hz)
- 10 dB attenuation, switchable
- Integrated phantom power supply adapter
- Flexible alignment due to gooseneck
- Black (CM-22G...B) or white (CM-22G...W) version
- Supplied with windshield

Total length:

CM-22G6...: 205 mm

CM-22G12...: 340 mm



Model	CM-22G6B	CM-22G6W	CM-22G12B
Polar pattern	cardioid	cardioid	cardioid
System	condenser	condenser	condenser
Audio frequency range	20-20,000 Hz	20-20,000 Hz	20-20,000 Hz
Nominal impedance	100 Ω	100 Ω	100 Ω
Sensitivity	15.8 mV/Pa	15.8 mV/Pa	15.8 mV/Pa
Max. sound pressure	140 dB	140 dB	140 dB
Power supply	= 48 V, phantom power	= 48 V, phantom power	= 48 V, phantom power
Housing material	metal	metal	metal
Weight	140 g	140 g	160 g
Cable	8 m	8 m	8 m
Connection	XLR, bal.	XLR, bal.	XLR, bal.

ECM-306BU/SW

Order No. 0237270



ECM-306BU/WS

Order No. 0237280



USB boundary microphones

- For operating directly at a PC or laptop
- No driver installation required, device will be identified automatically
- Integrated A/D converter: 48 kHz/16 bits
- Power LED
- Additional headphone connection: 3.5 mm jack
- 1.2 m connection cable with micro USB/USB Type-A plug
- Rear cutout for fixed installation (e.g. wall mounting)

Model	ECM-306BU/SW	ECM-306BU/WS
Polar pattern	semi-cardioid	semi-cardioid
System	electret	electret
Audio frequency range	50-18,000 Hz	50-18,000 Hz
Sensitivity	3.2 mV/Pa	3.2 mV/Pa
Power supply	≙ 5 V via USB interface	≙ 5 V via USB interface
Dimensions	90 x 25 x 90 mm	90 x 25 x 90 mm
Weight	187 g	187 g
Cable	1.2 m	1.2 m
Connection	micro USB/USB Type-A plug	micro USB/USB Type-A plug

ECM-306BU/SW = black version
ECM-306BU/WS = white version



ECM-306B/SW

Order No. 0235790

ECM-306B/WS

Order No. 0235800

Boundary microphones

- On/off switch with power LED
- Low cut and 10 dB attenuation, switchable
- Integrated electronics for direct connection to a phantom power supply ≙ 17-48 V
- Electronically balanced AF output
- 6 m connection cable with 3-pole mini XLR/XLR
- Supplied in a foam-padded plastic case

Model	ECM-306B/SW, ECM-306B/WS
Polar pattern	semi-supercardioid
System	electret
Audio frequency range	30-20,000 Hz
Nominal impedance	250 Ω
Sensitivity	22 mV/Pa
Max. sound pressure	130 dB
Power supply	≙ 17-48 V, phantom power
Dimensions	90 x 25 x 90 mm
Weight	200 g
Cable	6 m
Connection	3-pole mini XLR/XLR

ECM-306B/SW = black version
ECM-306B/WS = white version



ECM-302B

Order No. 0232370

ECM-302B/WS

Order No. 0233630

Boundary microphones

- Integrated electronics for direct connection to a phantom power supply ≙ 17-48 V
- Transformer-balanced AF output
- 6 m connection cable with 3-pole mini XLR/XLR

Model	ECM-302B	ECM-302B/WS
Polar pattern	semi-cardioid	semi-cardioid
System	electret	electret
Audio frequency range	30-20,000 Hz	30-20,000 Hz
Nominal impedance	250 Ω	250 Ω
Sensitivity	22 mV/Pa	22 mV/Pa
Max. sound pressure	140 dB	140 dB
Power supply	≙ 17-48 V, phantom power	≙ 17-48 V, phantom power
Dimensions	Ø 120 mm x 22 mm	Ø 120 mm x 22 mm
Weight	350 g	350 g
Cable	6 m	6 m
Connection	3-pole mini XLR/XLR	3-pole mini XLR/XLR

ECM-302B = black version
ECM-302B/WS = white version



ECM-304BD

Order No. 0232510

ECM-304BD/WS

Order No. 0233270

Boundary microphones

- Switchable polar pattern: cardioid/omnidirectional
- Voltage supply via 1.5 V button cell (not supplied). Phantom power via mixer not required
- 4 m connection cable with 3.5/6.3 mm plug

Model	ECM-304BD	ECM-304BD/WS
Polar pattern	cardioid/omnidir.	cardioid/omnidir.
System	electret	electret
Audio frequency range	30-20,000 Hz	30-20,000 Hz
Nominal impedance	600 Ω/1,000 Ω	600 Ω/1,000 Ω
Sensitivity	7 mV/Pa	7 mV/Pa
Power supply	1.5 V button cell (LR44)	1.5 V button cell (LR44)
Admiss. ambient temp.	0-40 °C	0-40 °C
Dimensions	70 x 96 x 20 mm	70 x 96 x 20 mm
Weight	285 g	285 g
Cable	4 m	4 m
Connection	3.5/6.3 mm plug	3.5/6.3 mm plug

ECM-304BD = black version
ECM-304BD/WS = white version



Desktop Microphones

ECM-500

Order No. 0232550

PA desktop microphone, with gooseneck.

- Electret, cardioid polar pattern
- Indicating light for mic. operation
- ON/OFF switch
- Battery-operated
- Removable gooseneck (XLR connection)
- Solid version



ECM-450

Order No. 0233370

PA desktop microphone, with gooseneck.

- Electret, cardioid polar pattern
- Volume control for speech and chime
- Different types of chimes can be selected
- Automatic chime activation (can be switched off)
- Power is provided via enclosed power



- supply or batteries (not supplied)
- 1.5 m connection cable with 6.3 mm connector (on both ends)

ECM-310P

Order No. 0232430

PA desktop microphone, with gooseneck.

- Electret, cardioid polar pattern
- Phantom power
- ON/OFF switch
- 3 m connection cable with XLR plug, balanced



ECM-200

Order No. 0230280

PA desktop microphone, with gooseneck.

- Electret, omnidirectional polar pattern
- Push-to-talk button and lock button



PDM-302

Order No. 0235560

PA desktop microphone, with gooseneck.

- Dynamic, cardioid polar pattern
- Low-noise push-to-talk switch, latching or non-latching
- 5 m connection cable with XLR plug, balanced



PDM-302PTT

Order No. 1000609



PA desktop microphone, with gooseneck.

- Dynamic, cardioid polar pattern
- Low-noise momentary push-to-talk button
- 4.8 m connection cable with XLR plug, balanced



PDM-300

Order No. 0231200

PA desktop microphone, with gooseneck.

- Dynamic, cardioid polar pattern
- Low-noise push-to-talk switch, latching or non-latching
- 1 m helix cable, balanced, with 6.3 mm mono plug



Model	ECM-500	ECM-450	ECM-310P	ECM-200	PDM-302	PDM-302PTT	PDM-300
Polar pattern	cardioid	cardioid	cardioid	omnidir.	cardioid	cardioid	cardioid
System	electret	electret	electret	dynamic	dynamic	dynamic	dynamic
Audio frequency range	100-16,000 Hz	100-12,000 Hz	80-14,000 Hz	60-12,000 Hz	60-12,000 Hz	60-12,000 Hz	60-12,000 Hz
Nominal impedance	600 Ω	600 Ω	250 Ω	1 kΩ	600 Ω	600 Ω	600 Ω
Sensitivity	3.9 mV/Pa	3.2 mV/Pa	8 mV/Pa	6 mV/Pa	3.2 mV/Pa	3.2 mV/Pa	3.2 mV/Pa
S/N ratio	> 40 dB	> 40 dB	> 55 dB	> 40 dB	-	-	-
Power supply	2 x 1.5 V batt. AA size	via encl. power supply or 2 x 1.5 V batt. C size	≈ 22-48 V, phantom power	1 x 1.5 V batt. AA size	-	-	-
Dimensions	135 x 60 x 145 mm (console housing) 450 mm (length of gooseneck)	180 x 50 x 130 mm (console housing) 210 mm (length of gooseneck)	Ø 80 mm x 25 mm (console housing) 200 mm (length of gooseneck)	75 x 25 x 110 mm (console housing), 200 mm (length of gooseneck)	120 x 60 x 160 mm (console housing)	120 x 60 x 160 mm (console housing)	120 x 60 x 160 mm (console housing) 310 mm (length of gooseneck)
Weight	1.46 kg	925 g	380 g	298 g	1 kg	1.02 kg	810 g
Cable	-	1.5 m	3 m	3 m	5 m	4.8 m	1 m
Connection	1 x XLR	6.3 mm jack low-voltage jack	XLR, bal.	6.3 mm plug	XLR, bal.	XLR, bal.	6.3 mm plug

DMG-700

Order No. 0232630

Dynamic gooseneck microphone

- Balanced connection
- Cardioid polar pattern
- 3-pole XLR connection
- Total length: 700 mm
- Supplied with microphone windshield WS-40

Model	DMG-700
Polar pattern	cardioid
System	dynamic
Audio frequency range	80-16,000 Hz
Nominal impedance	500 Ω
Sensitivity	1.4 mV/Pa
Dimensions	Ø 30 mm x 700 mm
Weight	232 g
Connection	3-pole XLR



DMG-600

Order No. 0231560

Dynamic gooseneck microphone

- Balanced version
- Cardioid polar pattern
- 3-pole XLR plug
- Total length: 565 mm

Model	DMG-600
Polar pattern	cardioid
Audio frequency range	200-12,000 Hz
Nominal impedance	500 Ω
Sensitivity	2 mV/Pa
Dimensions	Ø 21 mm x 565 mm
Weight	162 g
Connection	XLR



DMG-450

Order No. 0232620

Dynamic gooseneck microphone

- Balanced connection
- Cardioid polar pattern
- 3-pole XLR connection
- Total length: 450 mm
- Supplied with microphone windshield WS-40

Model	DMG-450
Polar pattern	cardioid
System	dynamic
Audio frequency range	80-16,000 Hz
Nominal impedance	500 Ω
Sensitivity	1.4 mV/Pa
Dimensions	Ø 30 mm x 450 mm
Weight	170 g
Connection	3-pole XLR



DMG-400

Order No. 0231550

Dynamic gooseneck microphone

- Excellent sound characteristics
- Balanced version
- Cardioid polar pattern
- M10 threaded part (length: 8 mm)
- For console and front mounting
- Total length: 385 mm

Model	DMG-400
Polar pattern	cardioid
Audio frequency range	150-12,000 Hz
Nominal impedance	500 Ω
Sensitivity	2.2 mV/Pa
Dimensions	Ø 28 mm x 385 mm
Weight	219 g
Connection	open cable ends



DMS-5

Order No. 0235730

Desktop microphone base, for gooseneck microphones.

- High-quality reed switch (on/off)
- Selector switch for type of microphone (electret/dynamic)
- Non-slip diecast housing
- Microphone connection via XLR jack with latching device
- XLR output, balanced connection
- Operation via 48 V phantom power or two 1.5 V batteries AA size (not supplied)
- Dimensions: 140 x 50 x 155 mm
- Weight: 1.1 kg



DMS-1

Order No. 0233490

Desktop microphone base, for gooseneck microphones.

- On/off switch
- Non-slip diecast housing
- Microphone connection via XLR jack with latching device
- XLR output, balanced connection
- Dimensions: 135 x 55 x 145 mm
- Weight: 1.3 kg



Desktop Microphones

EMG-650P

Order No. 0234330

Electret gooseneck microphone, with switchable low cut filter.

This microphone features an excellent radiation and a clear voice reproduction.

- Cardioid polar pattern
- Wide transmission range

Model	EMG-650P
Polar pattern	cardioid
System	electret
Audio frequency range	30-18,000 Hz
Nominal impedance	180 Ω
Sensitivity	4.5 mV/Pa
Max. sound pressure	130 dB
Power supply	≈ 9-48 V, phantom power
Dimensions	Ø 9/19 mm x 600 mm
Weight	171 g
Connection	XLR

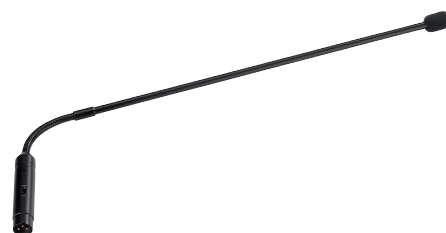

EMG-610P

Order No. 0232810

Electret gooseneck microphone, with red lighting ring.

- Particularly suitable for PA applications
- Cardioid polar pattern
- Microphone windshield
- Threaded part: Ø 10 mm x 40 mm

Model	EMG-610P
Polar pattern	cardioid
System	electret
Audio frequency range	100-16,000 Hz
Nominal impedance	1 kΩ
Sensitivity	4 mV/Pa
Power supply	≈ 3-9 V, external via optional power supply
Dimensions	Ø 13/19 mm x 450 mm
Weight	175 g
Connection	open cable ends



EMG-600P

Order No. 0232800

Electret gooseneck microphone, with red lighting ring.

- Particularly suitable for PA applications
- Cardioid polar pattern
- Microphone windshield
- 3-pole XLR plug

Model	EMG-600P
Polar pattern	cardioid
System	electret
Audio frequency range	100-16,000 Hz
Nominal impedance	1 kΩ
Sensitivity	4 mV/Pa
Power supply	≈ 3-9 V, external via optional power supply
Dimensions	Ø 13/19 mm x 445 mm
Weight	160 g
Connection	3-pole XLR



EMG-648P

Order No. 0233250

Electret gooseneck microphone, with red lighting ring.

- Particularly suitable for PA applications
- Transformer-balanced
- Cardioid polar pattern
- Microphone windshield

Model	EMG-648P
Polar pattern	cardioid
System	electret
Audio frequency range	50-16,000 Hz
Nominal impedance	300 Ω
Sensitivity	4 mV/Pa
Power supply	≈ 9-48 V, phantom power
Dimensions	Ø 13/19 mm x 440 mm
Weight	160 g
Connection	3-pole XLR



EMG-500P

Order No. 0231980

Electret gooseneck microphone

- Transformer-balanced
- Cardioid polar pattern
- Microphone windshield
- 3-pole XLR plug
- Total length: 480 mm

Model	EMG-500P
Polar pattern	cardioid
System	electret
Audio frequency range	80-16,000 Hz
Nominal impedance	250 Ω
Sensitivity	5 mV/Pa
Max. sound pressure	130 dB
Power supply	≈ 9-48 V, phantom power
Dimensions	Ø 19 mm x 480 mm
Weight	194 g
Connection	3-pole XLR



ECM-10/SW

Order No. 0232720

ECM-10/WS

Order No. 0232730

Built-in electret microphones

- Particularly suitable for PA applications
- Metal housing
- Black (SW) or white (WS) cartridge cover

Model	ECM-10/SW	ECM-10/WS
Polar pattern	omnidir.	omnidir.
System	electret	electret
Audio frequency range	30-17,000 Hz	30-17,000 Hz
Nominal impedance	300 Ω	300 Ω
Sensitivity	2.3 mV/Pa	2.3 mV/Pa
Max. sound pressure	110 dB	110 dB
Power supply	≈ 9-48 V, phantom power	≈ 9-48 V, phantom power
Housing material	metal	metal
Dimensions	Ø 30 mm x 71 mm	Ø 30 mm x 71 mm
Weight	92 g	95 g
Connection	XRL, bal.	XRL, bal.



GM-5212LDU

Order No. 0236290



GM-5215LDU

Order No. 0236310



Double gooseneck microphones with LED

- Back electret supercardioid cartridges
- High sensitivity
- 10 dB attenuator
- Low cut switch
- LED for indicating operating status
- Flexible positioning due to vertically adjustable goosenecks (160°)
- Common 3-pole XLR plug
- Operation via +48 V phantom power

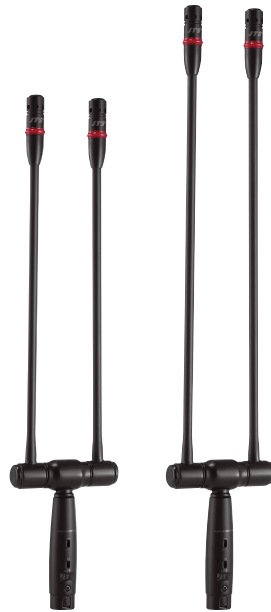

Model	GM-5212LDU	GM-5215LDU
Polar pattern	supercardioid	supercardioid
System	back electret	back electret
Audio frequency range	80-18,000 Hz	80-18,000 Hz
Nominal impedance	220 Ω	220 Ω
Sensitivity	16 mV/Pa	16 mV/Pa
Max. sound pressure	125 dB	125 dB
Power supply	= 48 V phantom power	= 48 V phantom power
Dimensions	415 mm	492 mm
Weight	315 g	335 g
Connection	XLR, bal.	XLR, bal.

GM-5212L

Order No. 0234410



GM-5218L

Order No. 0234420



Electret gooseneck microphones with LED

- Supercardioid polar pattern
- Natural sound
- Frequency response perfectly matched to the voice, precise voice reproduction
- Low susceptibility to acoustic feedback
- LED for indicating operating status
- Solid and high-quality workmanship to ensure a long service life
- Gooseneck with integrated 3-pole XLR plug
- Operation via external phantom power or desktop base DMS-5

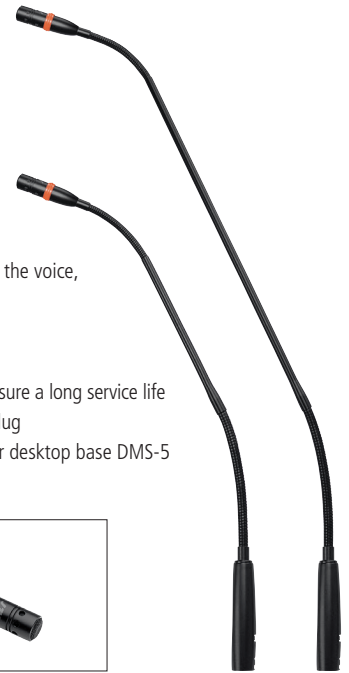

Model	GM-5212L	GM-5218L
Polar pattern	supercardioid	supercardioid
System	electret	electret
Audio frequency range	80-18,000 Hz	80-18,000 Hz
Nominal impedance	220 Ω ± 30%	220 Ω
Sensitivity	12.6 mV/Pa	12.6 mV/Pa
Max. sound pressure	125 dB	125 dB
Power supply	= 48 V phantom power	= 48 V phantom power
Dimensions	465 mm	615 mm
Weight	165 g	185 g
Connection	XLR, bal.	XLR, bal.

GML-5212

Order No. 0234560



GML-5218

Order No. 0234570



Electret gooseneck microphones with LED

- 3 replaceable microphone cartridges with different polar patterns (cardioid, supercardioid and omnidirectional)
- Excellent speech intelligibility
- -10 dB PAD switch
- Switchable low cut filter
- LED for indicating operating status
- Solid and high-quality workmansh. to ensure a long service life
- Gooseneck with integrated 3-pole XLR plug
- Operation via external phantom power or mic. base DMS-5



Model	GML-5212	GML-5218
Polar pattern	cardioid/supercardioid/omnidir.	cardioid/supercardioid/omnidir.
System	back electret	back electret
Audio frequency range	80-18,000 Hz	80-18,000 Hz
Nominal impedance	220 Ω ± 30%	220 Ω ± 30%
Sensitivity	16 mV/Pa	16 mV/Pa
Max. sound pressure	125 dB	125 dB
Power supply	= 48 V phantom power	= 48 V phantom power
Dimensions	465 mm	615 mm
Weight	230 g	245 g
Connection	XLR, bal.	XLR, bal.

GM-5212

Order No. 0234380



GM-5218

Order No. 0234390



Electret gooseneck microphones

- Supercardioid polar pattern
- Excellent sound with a very high speech intelligibility
- Minimum susceptibility to acoustic feedback
- Solid and high-quality workmanship to ensure a long service life
- Gooseneck with integrated 3-pole XLR plug
- Operation via external phantom power or microphone base DMS-5

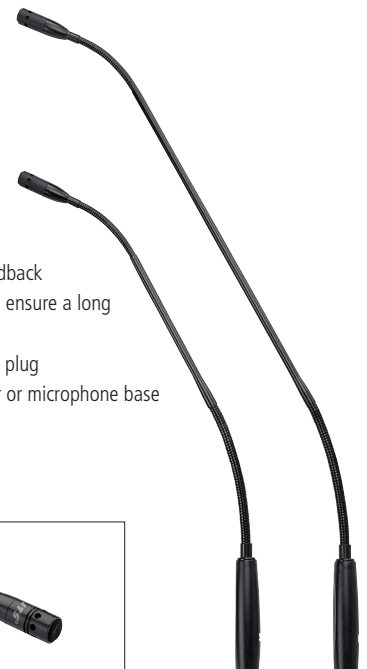

Model	GM-5212	GM-5218
Polar pattern	supercardioid	supercardioid
System	back electret	back electret
Audio frequency range	80-18,000 Hz	80-18,000 Hz
Nominal impedance	220 Ω ± 30%	220 Ω
Sensitivity	16 mV/Pa	16 mV/Pa
Max. sound pressure	125 dB	125 dB
Power supply	= 48 V phantom power	= 48 V phantom power
Dimensions	455 mm	605 mm
Weight	165 g	185 g
Connection	XLR, bal.	XLR, bal.

Induction Loop Systems Systems



LA-402

Order No. 0179160



Active loop amplifier, with dynamic compressor for setting up an audio induction loop system in large rooms up to 750 m².

Inductive transmission of audio signals allows users of hearing aids with a T-coil or induction loop receivers, e.g. the LR-202, to receive audio signals. Wireless transmission is an advantage of audio induction loop systems which makes it possible for the user to move freely within the loop.

Induction loop systems are used for various applications, e.g. as a hearing aid for the hearing impaired in houses of worship, theatres, cinemas, waiting rooms and lounges, as interpreting systems, for lectures in museums, exhibitions, etc.

With induction loop systems, an induction loop made of a wire winding is laid on the floor, the wall or along the ceiling and is controlled by a constant current amplifier. Thus, a magnetic field is created within the loop which induces a voltage into the T-coil of the hearing aid or into the induction loop receiver.

This voltage is then converted again into an audio signal in the receivers.

- Dynamic compressor
- Automatic talkover
- Metal loss correction 0-3 dB/oct.
- 3 mic/line inputs with 40 V phantom power, to be switched on additionally
- 6.3 mm input for inserting external devices
- Integrated SD card reader for reproduction of stored alarm messages
- 2-way tone control
- LED level meter
- 482 mm (19") rack installation with supplied mounting brackets

Model	LA-402
Loop current	14 A (peak)
Loop resistance	0.2-2 Ω
Room size	up to 750 m ²
Inputs	mic 1.5 mV/6.8 kΩ, XLR, bal. switchable to line 630 mV/10 kΩ, XLR, bal. line 630 mV/4.7 kΩ, RCA, unbal. alarm: 2 screw terminals for connecting a switch
Outputs	loop: 2 screw terminals
Equalizer bass	±10 dB, 100 Hz
Equalizer treble	±10 dB, 10 kHz
Frequency range	50-8,000 Hz
THD	< 1%
Admiss. ambient temp.	0-40 °C
Power supply	~ 230 V/50 Hz/230 VA
Dimensions	482 x 88 x 280 mm, 2 RU
Weight	6.97 kg

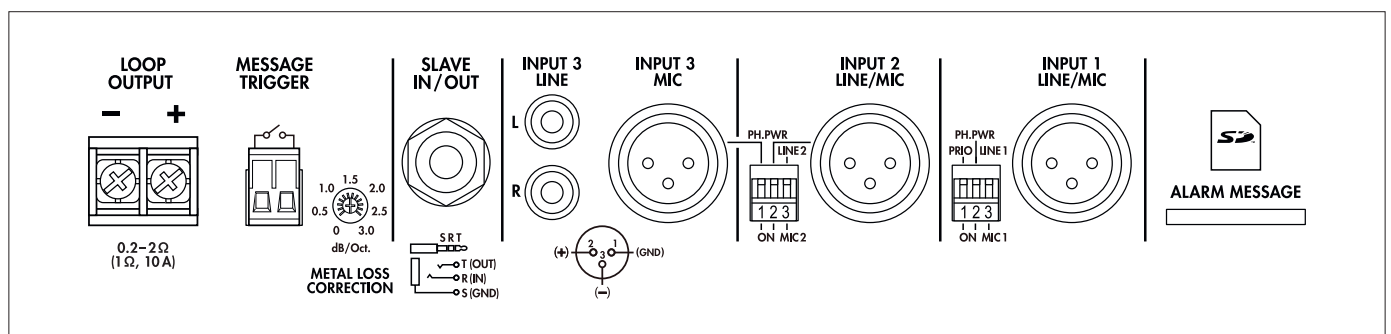



LA-202

Order No. 0176360



Active loop amplifier, in constant current technology with dynamic compressor for setting up an audio induction loop system in rooms up to 200 m². Inductive transmission of audio signals allows users of hearing aids with a T-coil or induction loop receivers, e.g. the LR-202, to receive audio signals. Wireless transmission is an advantage of audio induction loop systems which makes it possible for the user to move freely within the loop. Induction loop systems are used for various applications, e.g. as a hearing aid for the hearing impaired in houses of worship, theatres, cinemas, waiting rooms and lounges, as interpreting systems, for lectures in museums, exhibitions, etc.

With induction loop systems, an induction loop made of a wire winding is laid on the floor, the wall or along the ceiling and is controlled by a constant current amplifier. Thus, a magnetic field is created within the loop which induces a voltage into the T-coil of the hearing aid or into the induction loop receiver.

This voltage is then converted again into an audio signal in the receivers.

- Dynamic compressor
- Automatic talkover
- Metal loss correction 0-3 dB/oct.
- 3 mic/line inputs with 40 V phantom power, to be switched on additionally
- 6.3 mm input for inserting external devices
- Integrated SD card reader for reproduction of stored alarm messages
- 2-way tone control
- LED level meter
- 482 mm (19") rack installation with supplied mounting brackets

Model	LA-202
Loop current	7 A (peak)
Loop resistance	0.2-2 Ω
Room size	up to 200 m ²
Inputs	mic 1.5 mV/6.8 kΩ, XLR, bal. switchable to line 630 mV/10 kΩ, XLR, bal. line 630 mV/4.7 kΩ, RCA, unbal. alarm: 2 screw terminals for connecting a switch
Outputs	loop: 2 screw terminals
Equalizer bass	± 10 dB, 100 Hz
Equalizer treble	± 10 dB, 10 kHz
Frequency range	50-8,000 Hz
THD	< 1%
Power supply	~ 230 V/50 Hz/150 VA
Dimensions	482 x 88 x 280 mm, 2 RU
Weight	7 kg

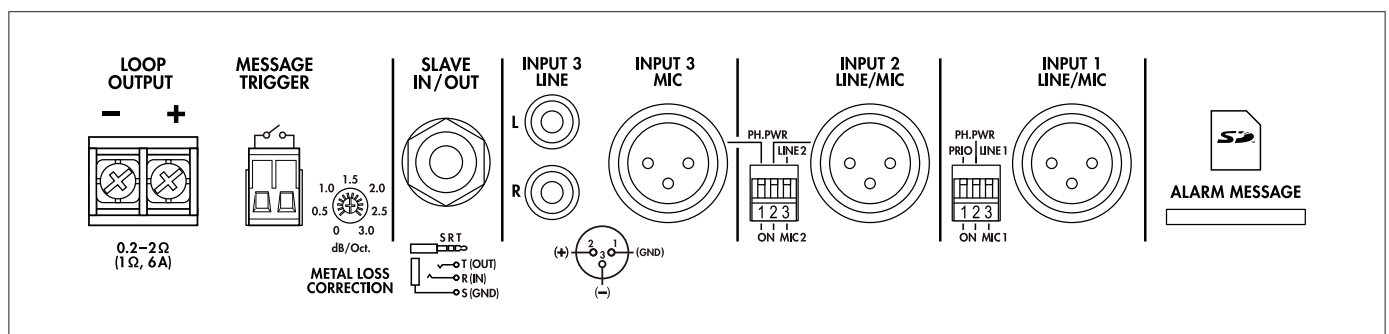

Induction Loop Systems Systems

LA-40

Order No. 0172330

Active loop amplifier, with dynamic compressor, specifically for setting up an audio induction loop system in domestic locations (up to 40 m²).

The loop amplifier LA-40 transmits the audio signals from a TV, audio system and/or microphone to the induction loop which is laid on the floor, the wall or along the ceiling. Thus, a magnetic field is created within the loop which is received by the T-coil of the hearing aid or the induction loop receiver and is then converted again into an audio signal. Wireless transmission is an advantage of induction loop systems. It makes it possible for the user to move freely within the loop and to adjust the volume of the hearing aid or receiving unit (LR-200) as desired, without disturbing the other occupants.

The LA-40 can be connected directly to the SCART jack of a TV (via supplied SCART adapter) or to an audio system. Talks of the other occupants can be heard via the connection of a microphone which is available at option. The integrated signal generator of the

LA-40 allows to create an alarm signal via an optional switch.

- Supplied with 35 m loop wire for setting up an induction loop, SCART adapter, power supply
- Integrated alarm signal can be activated as required
- Dynamic compressor
- Adjustable input sensitivity for line and microphone
- 2-way tone control
- Adjustable loop current
- LEDs for indicating power, signal/PEAK and loop current
- Headphone connection on the front panel
- Built-in phantom power for electret microphones
- Suitable microphone ECM-300LA is available at option



Model	LA-40
Loop current	2.8 A
Loop resistance	0.4-2 Ω
Room size	≤ 40 m ²
Inputs	mic: 2 mV/660 Ω (phantom power: 7.2 V) 6.3 mm jack line: 48 mV/11 kΩ, 2 x RCA alarm: 2 terminals for connecting a switch
Outputs	loop: connection of the supplied loop via 2 terminals headphones: ≥ 32 Ω, 3.5 mm jack
Equalizer bass	± 8 dB, 100 Hz
Equalizer treble	± 10 dB, 10 kHz
Frequency range	75-7,500 Hz, ±3 dB
THD	0.44%
Power supply	via encl. power supply
Dimensions	175 x 102 x 45 mm
Weight	510 g

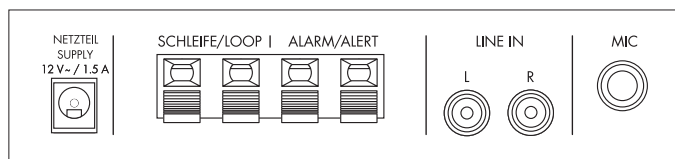

LR-202

Order No. 0176370

Induction loop receiver, for receiving audio signals in induction loop systems. The electromagnetic field which is created by an induction loop is received by the induction loop receiver and converted into an audio signal. Any number of receivers can be operated within one induction loop.

The unit is suitable for people with and without hearing problems and can be used for various applications:

- Hearing aid for the hearing impaired
- Operational test of induction loop systems
- Detection of stray radiation within a loop
- Interpretation systems
- Lectures in museums, at exhibitions, etc.

- 3.5 mm mono connection for headphones ≥ 32 Ω
- Volume control
- Low cut switch
- Belt clip
- Power supply via 9 V battery
- Dimensions: 60 x 112 x 35 mm
- Weight: 60 g

Model	LR-202
Power supply	9 V battery
Admiss. ambient temp.	0-40 °C
Dimensions	60 x 112 x 35 mm
Weight	60 g
Connections	3.5 mm mono jack



NL-90

Order No. 0173090

Induction loop, for wireless transmission of audio signals to hearing aids via optional pocket transmitter.

- Comfortable to wear around the neck (loop diameter: approx. 26 cm)
- Matching the pocket transmitters ATS-10R, ATS-16R, ATS-40R, TXA-800R
- 3.5 mm stereo jack connection



AUDIOPOINT-3

Order No. 0179040



Audio streamer

AUDIOPOINT-3 allows you to stream analogue audio signals, e.g. live audio, music or speech, with low latency to multiple portable devices and is ideally suited for the application in houses of worship, museums, lecture halls, schools and at trade shows or conferences.

- 50 users max. at the same time (up to 250 users after licence upgrade)
- 2 mono audio input channels
- Audio format: PCM/24 kHz/16 bits/mono
- No cloud server required
- Compatible with standard Wi-Fi routers
- Automatic detection and dynamic list of channels available (feature also available when using multiple devices)
- Easy installation, programming via web browser, access via IP address
- Free apps for Android and iOS are available from the respective store

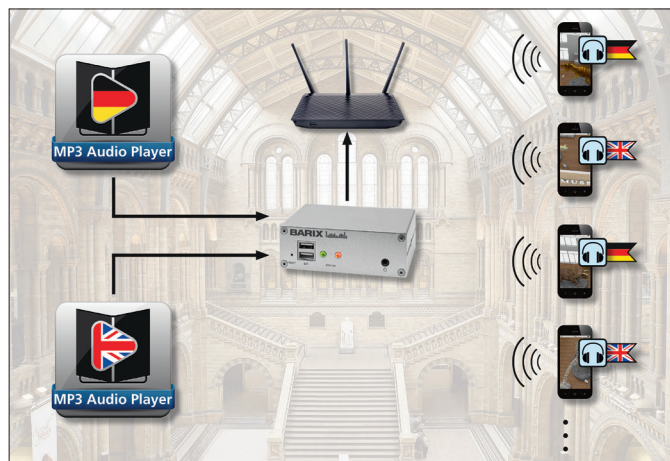
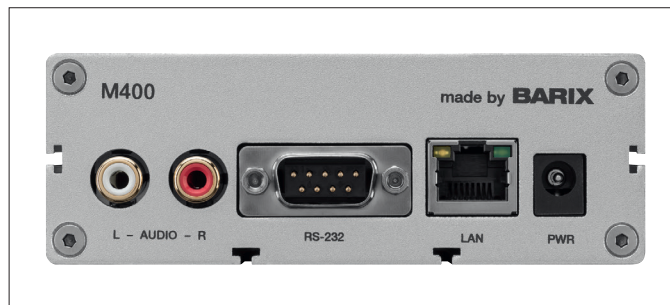

Model	AUDIOPOINT-3
Nominal value	240 kbps streaming
Colour	silver
Material	aluminium
Power supply	encl. power supply
Dimensions	118 x 40 x 85 mm
Weight	265 g
Connections	2 x RCA, 1 x RJ45 (LAN), 1 x RS232, 2 x USB, 3.5 mm jack (headphones)

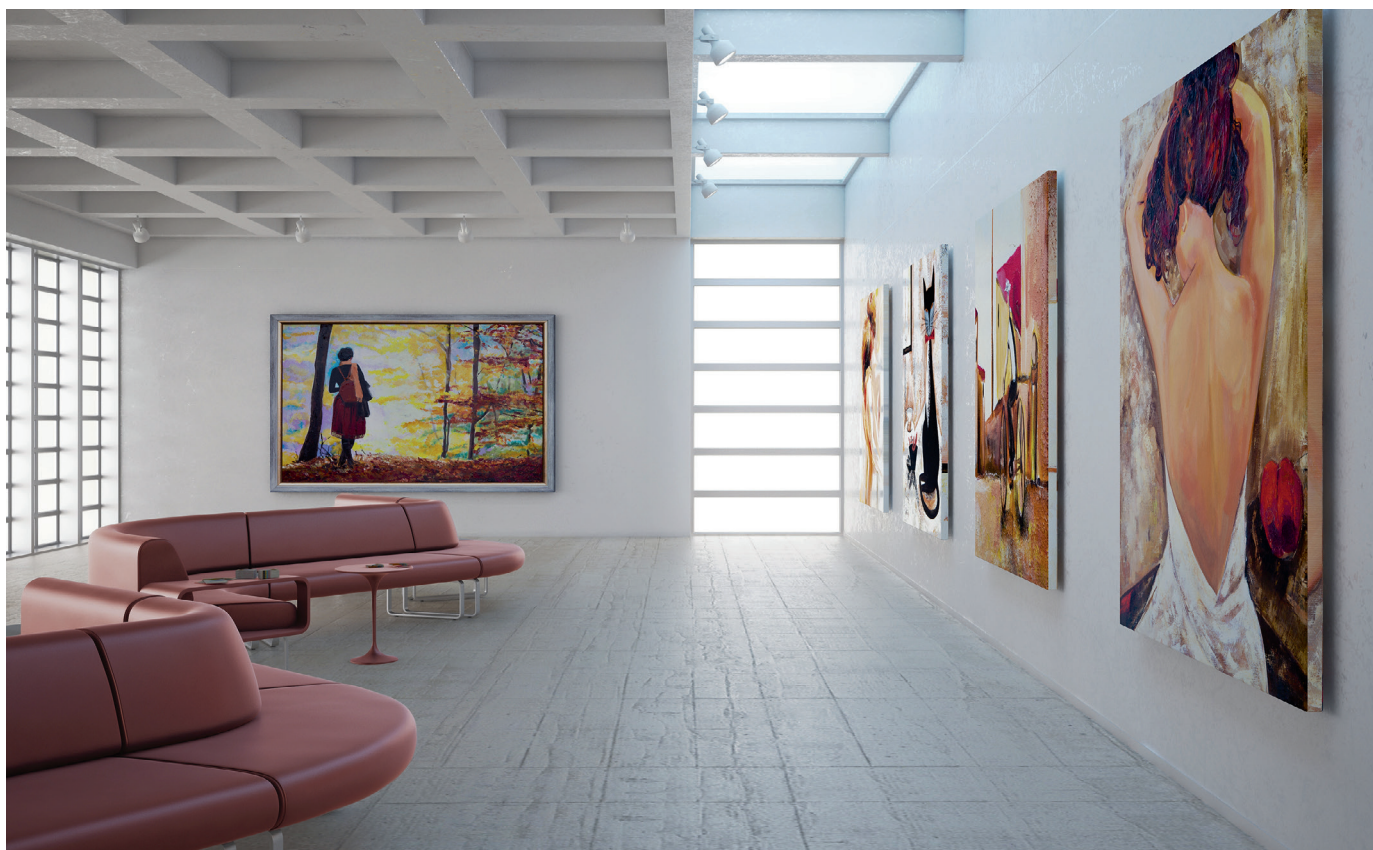

8

801C3 I137
850CH-2 I141

A

A-1 I68
ADP-AES3-2X2 I129
ADP-BT-AU-2X1 I129
ADP-DAI-1X0 I129
ADP-DAI-2X0 I129
ADP-DAO-0X1 I129
ADP-DAO-0X2 I129
ADP-USB-2X2 I129
ADP-USBC-2X2 I129
AES-5 I123
AES-6 I123
AES-7 I123
AKB-160 I21
AKB-160DT I127
AKB-60 I35
AKB-90WIFI I34
AKKU-12/120 I66
ANT-49 I142
ARM-880 I48
ARM-880RC I49
ARM-880RCE I49
ARM-880WP1 I49
ARM-880WP2 I49
ATT-19100 I56
ATT-1950 I56
ATT-20 I60
ATT-200 I59
ATT-200P I59
ATT-2100/WS I57
ATT-2100H/WS I58
ATT-212/WS I57
ATT-212H/WS I58
ATT-224/WS I57
ATT-224H/WS I58
ATT-235/WS I57
ATT-235H/WS I58
ATT-250/WS I57
ATT-250H/WS I58
ATT-300 I59
ATT-300C I59
ATT-306 I59
ATT-306PEU I57
ATT-3100PEU I57
ATT-312PEU I57

ATT-324PEU I57
ATT-325ST I59
ATT-336PEU I57
ATT-350PEU I57
ATT-400 I59
ATT-412PEU I58
ATT-424PEU I58
ATT-442ST I56
ATT-500PD I59
ATT-506PEU I57
ATT-5100PEU I57
ATT-512PEU I57
ATT-524PEU I57
AUDIOPOINT-3 I159

C

CAT-1TEST I38
CAT-1TOOL I38
CAT-7100A I37
CC-132 I38
CC-133 I38
CC-142 I38
CC-143 I38
CC-145 I38
CD-112/BT I41
CD-112RDS/BT I41
CD-156 I40
CH-2 I139
CH-8 I139
CLUB-1SUB I107
CLUB-1TOP I107
CM-214ULF I137
CM-22G12B I150
CM-22G6B I150
CM-22G6W I150
CM-502 I149
CM-502G12B I150
CM-502G12W I150
CM-502G6B I150
CM-502G6W I150
CM-502WT I149
CM-801F I137
CRB-130/WS I90
CRB-230/WS I90, I87
CS-1CH I133
CS-1CU I133
CS-1DU I133
CS-4 I134
CS-8 I134
CS-W4C/5 I132

CS-W4C/6 I132
CS-W4T/5 I132
CS-W4T/6 I132
CST-2 I38
CST-5 I38

D

D7P-10 I133
D7P-20 I133
DA-10-260/T I75, I123
DA-P20-130/T I75, I123
DADC-144DT I127
DH-10 I117
DH-95N I37
DH-95NP I37
DMG-400 I153
DMG-450 I153
DMG-600 I153
DMG-700 I153
DMP-102 I43
DMP-130MIXBT I40
DMS-1 I153
DMS-5 I153
DR-463 I41
DR-900SET I144
DRM-882LAN I46
DRM-882WP I47
DRM-882WPX I47
DRM-884 I44, I128
DRM-884DTM I128, I45
DRM-884IOP I45
DRM-884RC I45
DRM-884VAP I45
DRM-884VP I45

E

ECM-10/SW I154
ECM-10/WS I154
ECM-200 I152
ECM-300DT I127
ECM-302B I151
ECM-302B/WS I151
ECM-304BD I151
ECM-304BD/WS I151
ECM-306B/SW I151
ECM-306B/WS I151
ECM-306BU/SW I151
ECM-306BU/WS I151
ECM-310P I152

ECM-450	1152	EDL-80DT	1126, 190	ETS-432TW/WS	196
ECM-500	1152	EDL-82/WS	190, 180	ETS-442TW/WS	196
EDL-110/WS	1122	EDL-82HQ	190, 182	ETS-515TW/SW	197
EDL-116TW	177, 190	EMG-500P	1154	ETS-515TW/WS	197
EDL-118TW	177, 190	EMG-600P	1154	ETS-530TW/SW	197
EDL-11TW	179, 190	EMG-610P	1154	ETS-530TW/WS	197
EDL-11TW/SW	179, 190	EMG-648P	1154	ETS-630DT	1126
EDL-15	190, 177	EMG-650P	1154	EUL-2/SW	1108
EDL-155	190, 183	EPS-24HP	166	EUL-26/SW	1101
EDL-156	183, 190	EPS-CON	166	EUL-26/WS	1101
EDL-158	190, 183	ESP-1000AB	172, 193	EUL-2SUB/SW	1108
EDL-16	177, 190	ESP-134/WS	194	EUL-30/SW	199
EDL-165AB/WS	190, 174	ESP-15/WS	184, 190	EUL-30/WS	199
EDL-165C/WS	174, 190	ESP-152/WS	191	EUL-60/SW	199
EDL-18	177, 190	ESP-157/WS	191	EUL-60/WS	199
EDL-204	180, 190	ESP-17/WS	184, 190	EUL-75/WS	1100
EDL-206	190, 180	ESP-215/WS	1101	EVA-16/2	164
EDL-22/WS	190, 180	ESP-22/WS	190, 184	EVA-16FP/2	165
EDL-220/WS	1122	ESP-230/WS	1101	EVA-16IO	165
EDL-224ABC	190, 174	ESP-232/SW	1101	EVA-16REL/2	165
EDL-24	190, 177	ESP-232/WS	1101	EVA-16SYS80/2	164
EDL-25	177, 190	ESP-250/WS	1101	EVA-16TER/2	164
EDL-250/SW	1122	ESP-315/SW	1100	EVAB-22	161
EDL-250/WS	1122	ESP-315/WS	1100		
EDL-250C/WS	190, 174	ESP-32/WS	190, 184		
EDL-255/WS	1122	ESP-360/WS	194		
EDL-26	190, 177	ESP-50AB/WS	192, 173		
EDL-28	177, 190	ESP-50EN/WS	173, 192		
EDL-310L	185	ESP-5U	184		
EDL-36TW	190, 178	ESP-60/WS	193		
EDL-412/SW	1121	ESP-62/WS	192, 173		
EDL-412/WS	1121	ESP-62AB/WS	173, 191		
EDL-416EN/WS	1121, 172	ESP-63/WS	191		
EDL-420/SW	1120	ESP-70/WS	193		
EDL-420/WS	1120	ESP-72/WS	192		
EDL-42HQ	182, 190	ESP-80/WS	194		
EDL-430/WS	1120	ESP-8U	184		
EDL-435/WS	1120	ESP-90/WS	193		
EDL-530EN/SW	172	ESUB-6C/WS	181		
EDL-530EN/WS	172	ESUB-8F/WS	1105		
EDL-6	178, 190	ETS-120SL/WS	1105		
EDL-606	190, 176	ETS-210TW/WS	196		
EDL-606EN	190, 176	ETS-215/WS	197		
EDL-612	176, 190	ETS-215TW/WS	197		
EDL-612EN	176, 190	ETS-220TW/WS	196		
EDL-620	190, 176	ETS-230/WS	197		
EDL-620EN	190, 176	ETS-230TW/WS	197		
EDL-62HQ	182, 190	ETS-240TW/WS	196		
EDL-65TW	190, 183	ETS-340TW/WS	195		
EDL-70/WS	190, 179	ETS-360TW/WS	195		
EDL-706/12	190, 176	ETS-422TW/WS	196		
				F	
				FGA-30	162
				FGA-30M	162
				FGA-35	162
				FGA-40	162
				FGA-40HQ	162
				FGA-40MF	162
				FGM-170	1149
				FGM-170T	1149
				FM-102DAB	142
				G	
				GD-04K	166
				GM-5212	1155
				GM-5212L	1155
				GM-5212LDU	1155
				GM-5215LDU	1155
				GM-5218	1155
				GM-5218L	1155
				GML-5212	1155
				GML-5218	1155
				I	
				ICM-20H	135

- ILA-100RCA I56
 ILA-100XLR I56
 IMC-300T/EN I120
 IP-FORMER I130
 IT-100RTW I111
 IT-100TW I110
 IT-10M I119, I90
 IT-110 I113
 IT-115 I113
 IT-12D I135
 IT-12M I135
 IT-130 I113
 IT-130AK I109
 IT-15EN I112, I75
 IT-20 I112
 IT-230/VC I117
 IT-250TW I110
 IT-30 I112
 IT-32EN I112, I75
 IT-33 I112
 IT-35 I112
 IT-350/EN I74, I110
 IT-40 I111
 IT-40/VC I117
 IT-400DT I126
 IT-400RTW I109
 IT-400TW I109
 IT-60 I111
 ITH-300 I119
 IWA-05BT/WS I34
 IWA-50U/SW I34
 IWA-50WIFI/WS I34
- J**
- JSS-20/5 I138
 JSS-4B/5 I140
 JYSTY-2206 I37
 JYSTY-2208 I37
- K**
- KU-516 I118
 KU-516/VC I117
 KU-616T I118
 KU-616T/VC I117
 KU-916T I118
- L**
- LA-202 I157
 LA-40 I158
 LA-402 I156
 LKB-1 I60
 LPC-1 I61
 LR-202 I158
- M**
- M-32CD I43
 MA-935 I139
 MAESTRO-1 I71
 MCA-100J/XP I47
 MCA-100P/XP I47
 MCX-200/SW I54
 MDF-10TS-M I5
 MDF-12TS-M I5
 MDF-12Z I2
 MDF-15TS-M I5
 MDF-1632Z I3
 MDF-19TS-M I5
 MDF-24Z I2
 MDF-3264Z I3
 MDF-48Z I2
 MDF-816Z I3
 MDF-CON6 I4
 MDF-INS-HDWP I4
 MDF-INS-USB I4
 MDF-INS-XLR I4
 MEVAC-1CON I67
 MEVAC-1FH I67
 MEVAC-1FT I67
 MEVAC-2CON I67
 MEVAC-4 I67
 MEVAC-4PTT I67
 MFE-212 I53
 MKA-50SET/SW I104
 MKA-50SET/WS I104
 MKS-34/SW I103
 MKS-34/WS I103
 MKS-48/WS I100
 MKS-64/SW I103
 MKS-64/WS I103
 MKS-88/SW I103
 MKS-8PRO I103
 MMA-130 I21
 MMX-8 I61
 MOVE-08/BAG I106
 MOVE-08PMK2 I106
 MOVE-10/BAG I106
 MOVE-10PMK2 I106
 MOVE-12/BAG I106
- MOVE-12PMK2 I106
 MPS-8K I69
 MPS-8Z I68
 MPX-4PA I50
 MPX-52PA I51
 MXT-52MP3 I51
- N**
- NL-90 I158
 NR-10M I119, I90
 NR-12KS I116
 NR-15KS I116
 NR-18KS I116
 NR-20KS I116
 NR-22KS I115
 NR-24KS I115
 NR-254KS I113
 NR-25KS I115
 NR-33KS I114
 NR-35KS I114
 NR-40KS I114
 NR-60KS I114
- O**
- OMNI-CORD/SW I6
 OMNI-CORD/WS I6
 OMNI-REC/SW I7
 OMNI-REC/WS I7
 OMNI-TRACK/SW I6
 OMNI-TRACK/WS I6
 ONE-500 I68
 ONE-BC1 I69
 ONE-RMA I69
 ONE-RMA2 I69
 ONE-WMA I69
- P**
- PA-102 I35
 PA-1120 I13
 PA-1120DMT I16
 PA-1120RC I14
 PA-1140RCD I16
 PA-1200 I15
 PA-1200EX I16
 PA-1200M I52
 PA-1200RDSU I16
 PA-1200RM I15
 PA-12040 I10

PA-1240	I13	PA-924S	I27	RTF-1	I145
PA-1250D	I25	PA-928D	I17	RTF-20	I144
PA-1414MX	I53	PA-948	I17	RTF-2U	I145
PA-1450D	I23	PA-948S	I27	RTF-3	I145
PA-1480	I24	PA-M1WP	I9	RU-8011D/5	I136
PA-1850D	I23	PA-M224	I9	RU-8011DB/5	I136
PA-1960	I24	PA-M412	I9	RU-8012DB/5	I136
PA-2240	I22	PA-M4RC	I9	RU-850LTB/5	I137
PA-2400RC	I11	PAB-120WP/SW	I100	RU-850LTH/5	I136
PA-24AD	I52	PAB-12WP/SW	I102	RUP-5	I117
PA-24ESP	I71	PAB-306/SW	I107	RUS-5	I117
PA-24FMM	I16	PAB-306/WS	I107	RWM-1D	I38
PA-26FMU	I71	PAB-308/SW	I107	RWM-2D	I38
PA-302	I35	PAB-308/WS	I107	RWM-2H	I38
PA-306	I19	PAB-52WP/WS	I99		
PA-312	I19	PAB-68/SW	I102	S	
PA-324	I19	PAB-68/WS	I102	SA-100	I33
PA-4000PTT	I14	PAB-6WP/WS	I102	SA-130DMP	I32
PA-4000RC	I8	PAB-82WP/WS	I99	SA-160BT	I33
PA-40120	I8	PAB-8WP/WS	I102	SA-200	I32
PA-4040	I10	PAM-10	I35	SA-230/SW	I32
PA-4040MPX	I50	PATL-100/XC	I60	SA-250/SW	I32
PA-4120	I22	PATL-105	I12	SA-50	I33
PA-4120D	I23	PDM-300	I152	SAM-2	I63
PA-4240	I22	PDM-302	I152	SAM-200D	I63
PA-4300PTT	I14	PDM-302PTT	I152	SAM-300D	I63
PA-5000PTT	I14	PREAMP-1UP	I61	SAM-500D	I63
PA-5240	I13	PT-RMS	I137	SINUS-10	I25
PA-5480	I13			SINUS-20	I25
PA-6000RC	I14	R		SINUS-220	I22
PA-6010Z	I11	R-4/5	I140	SIP-HORN	I131
PA-6020Z	I11	R-4TBM/5	I141	SIP-MIC	I131
PA-6040MPX	I50	R-4THA/5	I140	SIP-SPEAK/SW	I130
PA-6240	I12	RACK-12W	I39	SIP-SPEAK/WS	I130
PA-6480	I12	RACK-12WP	I39	SLA-35	I55
PA-6600	I12	RACK-15NV	I39	SMC-1	I61
PA-6FD	I12	RACK-21NV	I39	SOUND-100SUB	I105
PA-6FM	I12	RACK-33NV	I39	SOUND-4BT/WS	I104
PA-6FR	I12	RACK-42NV	I39	SPC-515/BL	I37
PA-704	I20	RACK-625/42	I65	SPC-515/SW	I37
PA-803DAP	I20	RACK-625/42ST	I65	SPC-515/WS	I37
PA-806DAP	I20	RACK-6ALT	I70	SPC-525/SW	I37
PA-8120RCD	I18	RACK-6W	I39	SPE-110P/SW	I90, I89
PA-812DAP	I20	RACK-6WP	I39	SPE-110P/WS	I90, I89
PA-900	I18	RACK-MXT52MP3	I51	SPE-140/WS	I90, I86
PA-900DT	I128	RL-1EN	I121, I75	SPE-15/WS	I90, I85
PA-900S	I26	RL-1ENABDS	I75, I121	SPE-150/WS	I86, I90
PA-9100D	I17	RM-10SET	I145	SPE-158/WS	I86, I90
PA-912S	I27	RM-901	I145	SPE-15F/WS	I87, I90
PA-914D	I17	RP-900	I144	SPE-22/WS	I85, I90
PA-924	I18				

SPE-230/WS	187, 190	TR-175/6	160	WSA-2	1124
SPE-230BT	190, 189	TR-520	160	WSA-20BT	1124
SPE-252HQ	190, 185	TR-525	160	WSA-24R	1125
SPE-264/WS	188, 190	TS-C10-300/T	195	WSA-24T	1125
SPE-265/WS	190, 187	TS-C20-500/T	195	WSA-50WIFI	1125
SPE-284/WS	188, 190	TS-C30-700/T	195		
SPE-32/WS	185, 190	TS-C50-1000/T	195		
SPE-70/WS	188, 190			X	
SPE-72/WS	190, 188			XLR-703JSM	1148
SPE-82/WS	186, 190				
SPE-8U	185				
SPEECH-104D	1148	U			
SPEECH-204	1147	UA-960	1143		
SPEECH-500/GR	1146	UB-900I	1144		
SPS-20S	161	UC-900	1143		
SPS-40S	161	UDA-49A	1142		
SPS-41A	161	UDA-49P	1142		
SPS-80S	161	UF-20R/5	1138		
STA-1000D	130	UF-20S/5	1138		
STA-1504	128	UF-20TB/5	1139		
STA-1506	128	UHC-30	1115		
STA-1508	128	USP-124	1143		
STA-2000D	129	USP-900	1142		
STA-200D	131				
STA-225	131	V			
STA-235	131	VAP-1	170		
STA-300D	131	VAP-1EC	170		
STA-400D	130	VAP-8K	170		
STA-450D	129	VB-202A	161		
STA-800D	130	VCA-202	155		
STA-850D	129	VCA-202RN	155		
STE-21	169	VEN-625/24V	165		
STREAM	17	VMX-440/SW	151		
SUB-10	1107				
SUB/SW	17	W			
SUB/WS	17	W4-CH1	1132		
		W4-CH12	1132		
T		W4-CH12/COVER	1132		
TALKSAFE	136	WALL-04T/SW	198		
TALKSAFE-1	136	WALL-04T/WS	198		
TALKSAFE-HS	136	WALL-05DTM/WS	1126		
TFL-2	169	WALL-05SET/WS	1104		
TPE-TG44G	1127	WALL-05T/SW	198		
TPE-TG80G	1127	WALL-05T/WS	198		
TR-1005	160	WALL-06SET/WS	1104		
TR-1010LC	160	WALL-06T/SW	198		
TR-1025LC	160	WALL-06T/WS	198		
TR-1050LC	160	WALL-08T/SW	198		
TR-1120LC	160	WALL-08T/WS	198		
TR-175/10	160	WAP-202RS	142		
		WSA-10BT	1124		

All products of MONACOR INTERNATIONAL are tested continuously to ensure a constant quality level and to maintain quality standards. All products which are subject to the CE guidelines as well as the electric and electronic subassemblies which are subject to the directive for motor vehicles are tested according to the respective standards and carry the CE mark. These products can thus be sold in all EC countries without further tests or approvals.

General Information

- All rights reserved by MONACOR INTERNATIONAL GmbH & Co. KG. All contents of our catalogues, brochures and websites including texts, product images and graphics serve as information as to the products by MONACOR INTERNATIONAL only. No part of this catalogue including text, photos of products, graphics - or any parts thereof - may be reproduced in any form or by any means for any commercial use without our express prior written consent.
- Windows is a registered trademark of Microsoft Corporation in the United States and other countries.
- The software available on our websites is partly an 'Open Source Software' which is licenced under 'General Public License' (GPL). Further information can be found at the following link: <http://www.gnu.org/licenses/>.
- HDMI™ is a registered trademark of HDMI Licensing L.L.C.
- We cannot be held responsible for printing errors, should they occur. We reserve the right to make technical changes without prior notice.
- Specifications stated are according to information provided by the manufacturer.
- Technical data may vary slightly due to production tolerances.
- Damage resulting from unauthorised servicing of the products thus causing changes as well as improper handling resulting in consequential damage are excluded from the warranty. We will not be liable for changes of the state of the products resulting from improper storage, other interventions or improper use.
- Lithium batteries have to meet special regulations for transportation and storage. Before dispatching such products, please pay attention to the safety notes in the section 'Downloads' on our website.
- If the devices are interfered with, the CE approval will no longer apply. All products are usually suitable for indoor use only, unless stated otherwise. The products are not suitable for installations into aircrafts or for surface mounting onto aircrafts.
- The devices do not correspond to the medical products directive 2007/47/EC.
- If the devices are permanently taken out of operation, they must be taken to a local recycling plant for disposal which is not harmful to the environment.

Technical Information

- Before first use of the products, please read the instruction manual carefully!
- The products correspond to the directive for electromagnetic compatibility 2014/30/EU, the directive 2011/65/EU (RoHS) with the addition EU/2015/863 and where applicable to the low voltage directive 2014/35/EU with the directive 2009/125/EC (ErP) and the regulation 2019/1782.
- When operating with voltages of over 42 V, please always follow respective safety measures.
- Before opening any product operated with 230 V mains voltage, disconnect device from the mains.
- Make sure that the supply voltage is disconnected before working on components and modules. Existing capacitors must be discharged.
- Mains cables and test cables must be checked for damage on a regular basis. Never pull on the cable to disconnect the plug from the socket.
- Mains cables and fuses must only be replaced by skilled personnel.
- Unless otherwise stated:
 - protect the products from moisture and heat,
 - always observe the admissible ambient temperature of 0–40 °C.
- Do not use a very high volume level when using headphones. Permanent high volume may damage your hearing! Do not wear headphones while particular attention must be paid to your surroundings, e.g. in traffic.
- A soldering process which is too long and too hot may cause damage to the corresponding products. Choose a soldering temperature that is suitable for the material used. No liability can be assumed for damage to the product or consequential damage caused by improper handling.
- The plugs, jacks, switches, rotary switches and potentiometers shown in this catalogue are only suitable for connection to safety extra low voltage (SELV) or signal voltage unless the item is designed for a higher voltage (see text or table).
- If the fixing nuts of panel jacks or panel plugs are overtightened, it may cause damage to the whole component. In case of improper handling, no liability can be assumed for this or any consequential damage.
- The heat must be eliminated by air circulation. Therefore, do not cover ventilation slots with anything. Do not put or drop anything through the ventilation slots. Otherwise, there will be danger of an electric shock.
- Only use a dry, soft cloth for cleaning the products. Chemicals must not be used in any case.
- LED lights and LED lamps contain various components which may generate noise in unfavourable conditions. There may be audible resonances caused by installation, design of the lamp and the base as well as dimmer or transformer.

Notes on Devices with Network/Internet Access

Please note that each device connected to a network with Internet access is part of a worldwide network. In order to protect your privacy and to prevent unauthorised people accessing your network and the devices connected, please protect your login details with an individual password prior to initial installation. Please take this into consideration when assigning future passwords in connection with devices, software and apps available in the network, e.g. when setting up user accounts. Passwords should never be disclosed to third parties! Furthermore, please note that any device which has been connected to the network should be reset before being sold or disposed of. This is the only way to ensure that all your personal data is erased permanently.

Information on the German Product Liability Act

According to the law dated 15 December 1989 governing product liability which was last amended by the law dated 19 July 2002, manufacturers, importers and retailers are obliged to compensate for damage caused by a faulty product under certain prerequisites.

A product can already be considered faulty if its presentation leaves a private, non-commercial end user with a wrong impression as to its safety in use or if it is to be expected that the private end user will not observe the required safety regulations when using the product or will apply an excessive operating voltage to it, except if this user has been informed as to the necessity to observe the safety regulations and specified voltages, etc.

In your own interest and for your customers' safety, therefore please draw your non-commercial customers' attention to the following:

The products listed in this catalogue may only be used for the stated purpose. If there are any doubts as to the purpose of the goods, questions must be clarified with an authorised expert or with the service department of MONACOR INTERNATIONAL.

The following EN standards and VDE (Verband Deutscher Elektrotechniker = Association of German Electrical Engineers) regulations must be observed:

Electromagnetic Compatibility:

EN300422, EN301489, EN55032, EN55103-1, EN55103-2, EN61000-3-2, EN61000-3-3, EN61000-6-1, EN61000-6-3

Low Voltage Directive:

DINVDE0100, DINVDE0532, EN62368-1, EN60335, EN60598, EN61010, EN62471

Motor Vehicles Directive:

Directive 2004/104/EC

In Germany, the above-mentioned regulations can be obtained from:

VDE-Verlag GmbH Bismarckstraße 33 10625 Berlin Germany Phone: +49 30 348001-0 Fax: +49 30 348001-9088	VDE-Verlag GmbH Postfach 120143 10591 Berlin Germany Phone: +49 30 348001-0 Fax: +49 30 348001-9088	VDE-Verlag GmbH Kaiserleistr. 8 A 63067 Offenbach Germany Phone: +49 69 840006-0 Fax: +49 69 840006-1399
--	--	---

Notes Regarding the Approval of Wireless Systems

The wireless microphone systems in the frequency ranges 863 MHz to 865 MHz and 2,4 GHz are generally approved and licence-free in the EU.

The wireless systems in the frequency range 506 MHz to 542 MHz, 518 MHz to 542 MHz, 672 MHz to 694 MHz are generally approved according to directive 34/2020 and are licence-free in Germany.

Every wireless system has been examined by a notified body and has been approved in the EU according to the RED directive. However, a frequency assignment for the systems in the frequency range 740 MHz to 776 MHz, 823 MHz to 832 MHz and 1.8 GHz for the corresponding area in which the device is to be used must be applied for at the respective national authority. There are restrictions or requirements within the EU.

In Germany, the frequency assignment has to be applied for at the corresponding branch of the Federal Network Agency (BNetzA, Germany).

The declaration of conformity can be found on our website: www.monacor.com, www.img-stageline.com or www.jts-europe.com. The forms for the frequency assignment can be found on the website of the Federal Network Agency www.bundesnetzagentur.de. For countries outside of Europe, please consult the authorities of the corresponding country.

Please observe the notes in the operating instructions.

MONACOR INTERNATIONAL GmbH & Co. KG; October 2021

MONACOR INTERNATIONAL – Your reliable partner – worldwide.



THE AUDIO COMPANY

**HEADQUARTERS
MONACOR INTERNATIONAL**

Zum Falsch 36
28307 Bremen
Germany
Tel.: +49 421 4865-0
Fax: +49 421 488415
info@monacor.com
www.monacor-international.com

Your retailer



MONACOR and IMG STAGELINE are brands of the company group
MONACOR INTERNATIONAL.

www.monacor-international.com